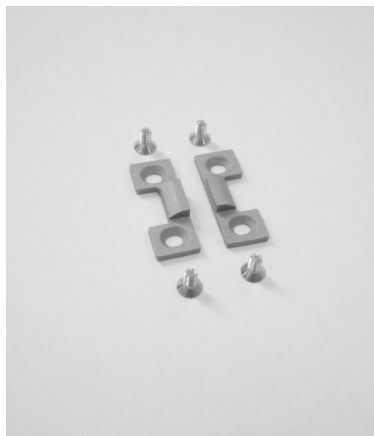

**AC 2624E.D**

Kit cremonese dx per finestre a due ante  
Gratz con maniglia removibile  
*RH cremone bolt set for double leaf windows*  
*Gratz mechanism with removable handle*

**AC 2624E.S**

Kit cremonese sx per finestre a due ante  
Gratz con maniglia removibile  
*LH cremone bolt set for double leaf windows*  
*Gratz mechanism with removable handle*

**AC 2627**

Chiusura mediana lato cerniere  
*Hinge-side middle closing*

**AC 2625.D**

Kit cremonese dx per finestre ad un'anta | PR2943  
*RH cremone bolt set for single leaf windows | PR2943*

**AC 2625.S**

Kit cremonese sx per finestre ad un'anta | PR2943  
*LH cremone bolt set for single leaf windows | PR2943*

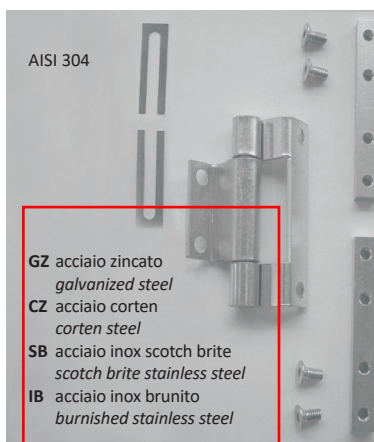

AISI 304

**AC 2628.xx**

Cerniera a tre ali da avvitare PR2933  
Peso max anta 100 kg  
*Three-wing screw-on hinge PR2933*  
*Max leaf weight 100 kg*

**GZ** acciaio zincato galvanizzato steel  
**CZ** acciaio corten corten steel  
**SB** acciaio inox scotch brite scotch brite stainless steel  
**IB** acciaio inox brunito burnished stainless steel

**AC 2625E.D**

Kit cremonese dx per finestre ad un'anta | PR2943  
Gratz con maniglia removibile  
*RH cremone bolt set for single leaf windows | PR2943*  
*Gratz mechanism with removable handle*

**AC 2625E.S**

Kit cremonese sx per finestre ad un'anta | PR2943  
Gratz con maniglia removibile  
*LH cremone bolt set for single leaf windows | PR2943*  
*Gratz mechanism with removable handle*



AISI 304

**AC 2629.xx.D**

Cerniera dx a due ali da avvitare PR2933  
Peso max anta 50 kg  
*RH two-wing screw-on hinge PR2933*  
*Max leaf weight 50 kg*

**IZ** acciaio inox verniciabile | paintable stainless steel  
**CZ** acciaio corten grezzo | untreated corten steel  
**SB** acciaio inox scotch brite | scotch brite stainless steel  
**IB** acciaio inox brunito | burnished stainless steel

**AC 2626R**

Punto di chiusura aggiuntivo per finestra

*Additional locking point for windows*



AISI 304

**AC 2629.xx.S**

Cerniera sx a due ali da avvitare PR2933  
Peso max anta 50 kg  
*LH two-wing screw-on hinge PR2933*  
*Max leaf weight 50 kg*

**IZ** acciaio inox verniciabile | paintable stainless steel  
**CZ** acciaio corten grezzo | untreated corten steel  
**SB** acciaio inox scotch brite | scotch brite stainless steel  
**IB** acciaio inox brunito | burnished stainless steel

**AC 2631.A**

Cerniera a due ali in acciaio zincato a saldare | Ø 10  
Peso max anta 40 kg

*Weld-on hinge in galvanised steel | Ø 10  
Max leaf weight 40 kg*

**AC 2636.x**

Guarnizione automatica di tenuta sotto porta

*Automatic bottom seal*

AC2636.Z lunghezza/length 315 - 430 mm  
AC2636.A lunghezza/length 380 - 530 mm  
AC2636.B lunghezza/length 480 - 630 mm  
AC2636.C lunghezza/length 580 - 730 mm  
AC2636.D lunghezza/length 680 - 830 mm  
AC2636.E lunghezza/length 780 - 930 mm  
AC2636.F lunghezza/length 880 - 1030 mm  
AC2636.G lunghezza/length 980 - 1130 mm  
AC2636.H lunghezza/length 1080 - 1230 mm

**AC 2631.B**

Cerniera a due ali in acciaio zincato a saldare | Ø 13  
Peso max anta 70 kg

*Weld-on hinge in galvanised steel | Ø 13  
Max leaf weight 70 kg*

**AC 2639.xx**

Kit cerniere a scomparsa per vasistas "ochette"  
Solo per profilo PR2933

*Concealed hinges for bottom-hung windows  
Only for PR2933 profile*

IZ acciaio inox verniciabile | paintable stainless steel  
CZ acciaio corten grezzo | untreated corten steel  
ST acciaio inox scotch brite | scotch brite stainless steel  
IB acciaio inox brunito | burnished stainless steel

**AC 2632.B**

Cerniera registrabile a due ali in acciaio zincato a saldare | Ø 13  
Peso max anta 70 kg

*Adjustable weld-on hinge in galvanised steel | Ø 13  
Max leaf weight 70 kg*

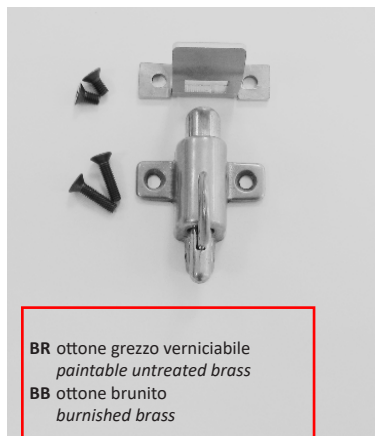
**AC 2640.xx**

Cricchetto per vasistas

*Finger catch for bottom-hung windows*

BR ottone grezzo verniciabile  
paintable untreated brass  
BB ottone brunito  
burnished brass

**AC 2632.C**

Cerniera registrabile a due ali in acciaio zincato a saldare | Ø 16  
Peso max anta 80 kg

*Adjustable weld-on hinge in galvanised steel | Ø 16  
Max leaf weight 80 kg*

**AC 2641**

Braccetti per vasistas  
Peso max anta 40 Kg

*Stays for bottom-hung windows  
Max leaf weight 40 kg*

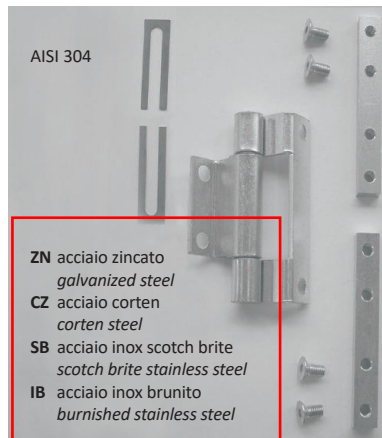
**AC 2648.xx**

Cerniera a tre ali da avvitare  
 su PR2943 (apertura interna)  
 su PR2962 (apertura esterna)  
 Peso max anta 100 kg

*Three-wing screw-on hinge  
 on PR2943 (inward opening)  
 on PR2962 (outward opening)  
 Max leaf weight 100 kg*

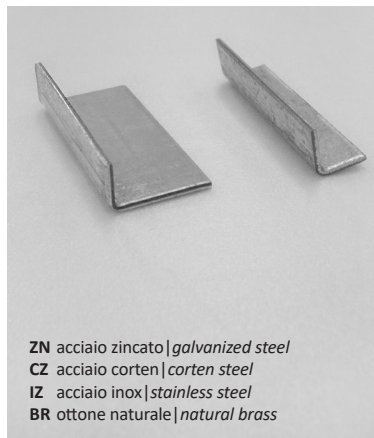
**AC 2652.xx**

Kit fondini per profili  
 PR2942 - PR2943

*Fittings kit for profiles  
 PR2942 - PR2943*

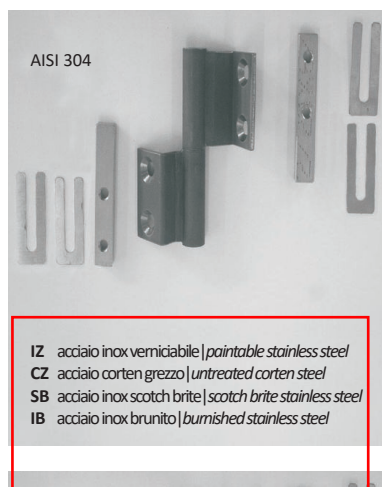
**AC 2649.xx.ISED**

Cerniera a due ali da avvitare  
 Sx su PR2943 (apertura interna)  
 Dx su PR2962 (apertura esterna)  
 Peso max anta 50 kg

*Two-wing screw-on hinge  
 LH on PR2943 (inward opening)  
 RH on PR2962 (outward opening)  
 Max leaf weight 50 kg*

Scelta verso cerniera pg. 5.3.1  
 Side hinge choice pg. 5.3.1

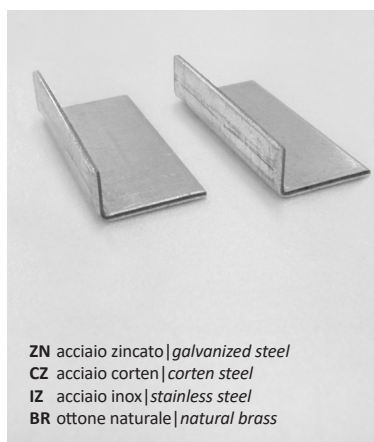
**AC 2653.xx**

Kit fondini per profili  
 PR2962 - PR2963

*Fittings kit for profiles  
 PR2962 - PR2963*

**AC 2649.xx.IDES**

Cerniera a due ali da avvitare  
 Dx su PR2943 (apertura interna)  
 Sx su PR2962 (apertura esterna)  
 Peso max anta 50 kg

*Two-wing screw-on hinge  
 RH on PR2943 (inward opening)  
 LH on PR2962 (outward opening)  
 Max leaf weight 50 kg*

Scelta verso cerniera pg. 5.3.1  
 Side hinge choice pg. 5.3.1

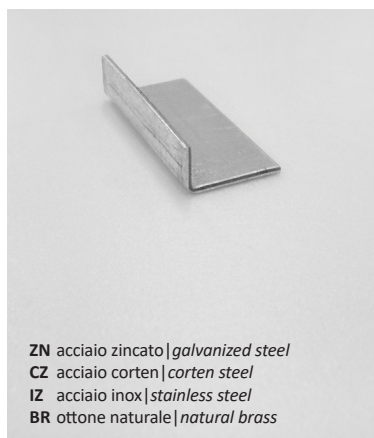
**AC 2654.xx**

Fondini per profili  
 PR2942 - PR2905 (PR2955)

*Fittings for profiles  
 PR2942 - PR2905 (PR2955)*

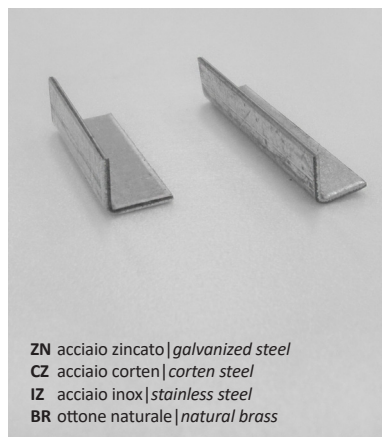
**AC 2651.xx**

Kit fondini per profili  
 PR2932 - PR2933

*Fittings kit for profiles  
 PR2932 - PR2933*

**AC 2658.xx**

Fondino per profili  
 PR2975 | PR2991 | PR2992  
 PR2993 | PR2995  
 (apertura interna)

*Fittings for profiles  
 PR2975 | PR2991 | PR2992  
 PR2993 | PR2995  
 (inward opening)*



**AC 2659.xx**

Fondino per profili  
PR2975 | PR2991 | PR2992  
PR2993 | PR2995  
(apertura esterna)

*Fittings for profiles*  
PR2975 | PR2991 | PR2992  
PR2993 | PR2995  
(outward opening)

**GZ** acciaio zincato | *galvanized steel*  
**CZ** acciaio corten | *corten steel*  
**I** acciaio inox | *stainless steel*  
**B** ottone naturale | *natural brass*

**AC 2684.D**

Kit cremone dx per finestre  
a due ante - apertura esterna

*RH cremone bolt set for double  
leaf windows - outward opening*

**AC 2684.S**

Kit cremone sx per finestre  
a due ante - apertura esterna

*LH cremone bolt set for double leaf  
windows - outward opening*

**AC 2680.xx**

Maniglia di trascimento  
per aperture esterne

*Pulling handle for outward  
opening*

**BR** ottone grezzo verniciabile | *paintable untreated brass*  
**BB** ottone brunito | *burnished brass*  
**CZ** acciaio corten grezzo | *untreated corten steel*  
**SB** acciaio inox scotch brite | *scotch-brite stainless steel*

**AC 2684E.D**

Kit cremone dx per finestre  
a due ante - apertura esterna  
Gratz con maniglia removibile  
*RH cremone bolt set for double  
leaf windows - outward opening  
Gratz mechanism with removable handle*

**AC 2684E.S**

Kit cremone sx per finestre  
a due ante - apertura esterna  
Gratz con maniglia removibile  
*LH cremone bolt set for double leaf  
windows - outward opening  
Gratz mechanism with removable handle*

**AC 2683.D**

Kit cremone dx per finestre  
ad un'anta - apertura esterna

*RH cremone bolt set for single leaf  
windows - outward opening*

**AC 2683.S**

Kit cremone sx per finestre  
ad un'anta - apertura esterna

*LH cremone bolt set for single leaf  
windows - outward opening*

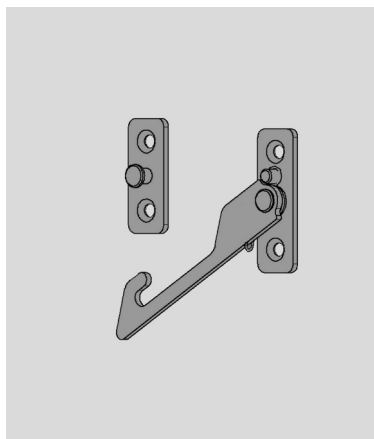
**AC 2685.D**

Limitatore di apertura per aereazione  
APR interna dx | APR esterna sx

*Window ventilation restrictor  
RH inward oPR | LH outward oPR*

**AC 2685.S**

Limitatore di apertura per aereazione  
APR interna sx | APR esterna dx

*Window ventilation restrictor  
LH inward oPR | RH outward oPR*

**AC 2683E.D**

Kit cremone dx per finestre  
ad un'anta - apertura esterna  
Gratz con maniglia removibile  
*RH cremone bolt set for single leaf  
windows - outward opening  
Gratz mechanism with removable handle*

**AC 2683E.S**

Kit cremone sx per finestre  
ad un'anta - apertura esterna  
Gratz con maniglia removibile  
*LH cremone bolt set for single leaf  
windows - outward opening  
Gratz mechanism with removable handle*

**AC 2686**

Braccetto limitatore di apertura  
frizionato

*Window restrictor*



**AC 2687**

Braccetto limitatore di apertura  
esterna finestra con blocco

*Casement stay  
outward opening*

**AC 2693**

Serratura con scrocco e  
catenaccio

*Latch and bolt lock*

**AC 2688**

Coppia compassi  
apertura a sporgere  
Peso massimo anta 100 kg

*Pair of side arms for  
awning opening  
Max leaf weight 100 kg*

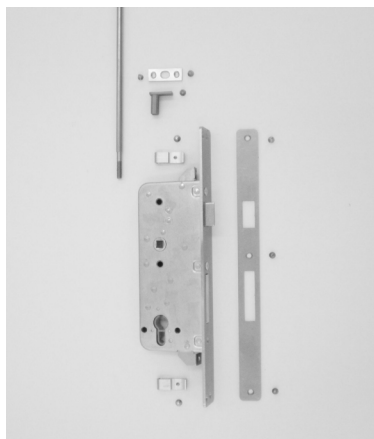
**AC 2694.D**

Kit serratura multipunto dx  
per porta

*RH Multi-lock set for door*

**AC 2694.S**

Kit serratura multipunto sx  
per porta

*LH Multi-lock set for door*

Vedi pg. 4.5.25 per la scelta  
For the choice see pg. 4.5.25

**AC 2689**

Coppia compassi  
apertura a sporgere  
Peso massimo anta 40 kg

*Pair of side arms for  
awning opening  
Max leaf weight 40 kg*

**AC 2695.D**

Punto di chiusura aggiuntivo  
dx per porta

*RH additional locking point for door*

**AC 2695.S**

Punto di chiusura aggiuntivo  
sx per porta

*LH additional locking point for door*

Vedi pg. 4.5.27 per la scelta  
For the choice see pg. 4.5.27

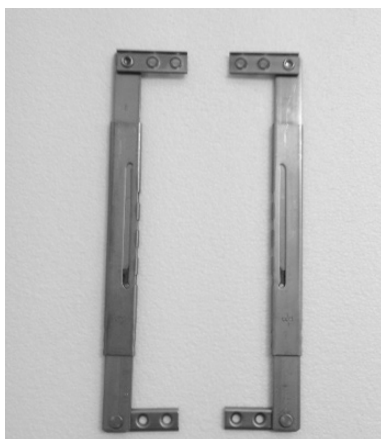
**AC 2690**

Braccetti limitatori  
apertura a sporgere

*Casement stays for  
awning opening*

**AC 2696.xx**

Scatola copri serratura  
Destra

*RH lock cover box*

AISI 304

ZN acciaio zincato | *galvanized steel*  
CZ acciaio corten | *corten steel*  
IZ acciaio inox | *stainless steel*  
BR ottone naturale | *natural brass*

Vedi pg. 4.5.25 per la scelta  
For the choice see pg. 4.5.25

AISI 304

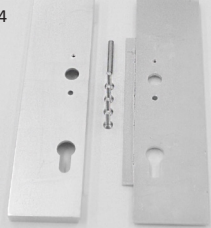

**ZN** acciaio zincato | *galvanized steel*  
**CZ** acciaio corten | *corten steel*  
**IZ** acciaio inox | *stainless steel*  
**BR** ottone naturale | *natural brass*

**AC 2697.xx**

Scatola copri serratura  
Sinistra

LH lock cover box

Vedi pg. 4.5.25 per la scelta  
For the choice see pg. 4.5.25

**AG 2580**

Coppia di cerniere a scomparsa  
per vasistas su profilo PR2543  
Peso max anta 70 kg

*Pair of concealed hinges for  
bottom hung window  
on PR2543 profile  
Max leaf weight 70 kg*

**AG 1386**

Limitatore di apertura frizionato  
per meccanismi A/R a scomparsa  
Solo per meccanismi EASY

*Friction stay for tilt-turn  
mechanism, concealed hinges  
Only for EASY mechanism*

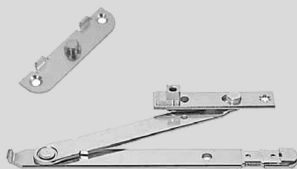
**AG 6530**

Limitatore di corsa per  
meccanismi A/R

*Opening limiter on tilt&turn  
mechanism*

**AG 2524**

Cerniera a tre ali ad avvitare per  
vasistas con profilo PR2543  
Peso max anta 70 kg

*Screw-on hinge for bottom-hung  
window with PR2543 profile  
Max leaf weight 70 kg*

**Solo con profilo telaio PR2513**  
**Only with frame profile PR2513**

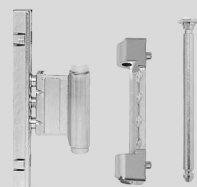
**CV 1023**

Vite per boccia fermavetri  
in alluminio, TPS 4.2x13

*Screw for aluminium glazing  
bead bushing, TPS 4.2x13*



**CV1023** acciaio zincato | *galvanized steel*  
**CV1023I** acciaio inox | *stainless steel*

**AG 1224C.xx**

Kit copertine in plastica per  
cerniere AG 2524

*Plastic cover for hinges AG 2524*

**AG1224C.AG** argento | *matt silver*  
**AG1224C.MC** marrone | *brown*  
**AG1224C.BC** bronzato chiaro | *light bronze plated*  
**AG1224C.BO** ottonato opaco | *matt brass plated*  
**AG1224C.OL** ottonato lucido | *brass plated*  
**AG1224C.NI** nichelato | *nickel*  
**AG1224C.WB** bianco RAL 9001 | *white RAL 9001*  
**AG1224C.WC** bianco RAL 9010 | *white RAL 9010*

**CV 1242**

Vite trilobata  
TPS M4x6

*Thread cutting machine screw  
TPS M4x6*



**CV1242** acciaio zincato | *galvanized steel*  
**CV1242I** acciaio inox | *stainless steel*

**CV 1243**

Vite trilobata  
TPS M4x8

*Thread cutting machine screw  
TPS M4x8*

CV1243 acciaio zincato | *galvanized steel*  
CV1243I acciaio inox | *stainless steel*

**CV 1244**

Vite trilobata  
TPS M4x12

*Thread cutting machine screw  
TPS M4x12*

CV1244 acciaio zincato | *galvanized steel*  
CV1244I acciaio inox | *stainless steel*

**CV 1271**

Vite trilobata  
TPS M4x16

*Thread cutting machine screw  
TPS M4x16*

CV1271 acciaio zincato | *galvanized steel*  
CV1271I acciaio inox | *stainless steel*

**CV 5012**

Boccola per fermavetri in  
alluminio

*Bushing for aluminium  
glazing bead*

CV5012 acciaio zincato | *galvanized steel*  
CV5012I acciaio inox | *stainless steel*

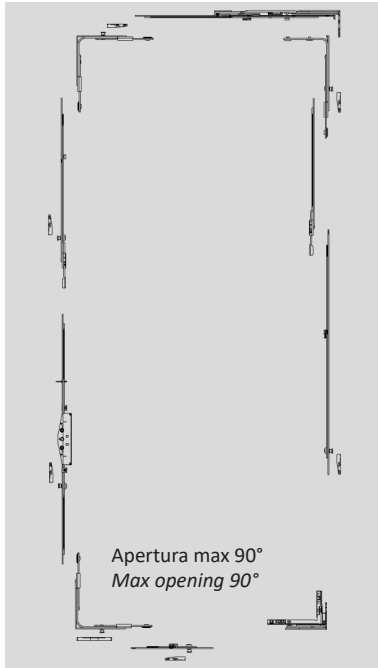

**AGE 581.xx**

Meccanismo A/R prima anta Dx cerniere a scomparsa

*First leaf RH tilt-turn mechanism with concealed hinges*

EASY

**AGE 582.xx**

Meccanismo A/R prima anta Sx cerniere a scomparsa

*First leaf LH tilt-turn mechanism with concealed hinges*

EASY

|                    |           | altezza - height |      |      |      |      |      |      |      |      |
|--------------------|-----------|------------------|------|------|------|------|------|------|------|------|
|                    |           | 670              | 861  | 1001 | 1201 | 1401 | 1601 | 1801 | 2001 | 2201 |
|                    |           | 860              | 1000 | 1200 | 1400 | 1600 | 1800 | 2000 | 2200 | 2400 |
| larghezza<br>width | 601-800   | A1               | B1   | C1   | D1   | E1   | F1   | G1   | H1   | I1   |
|                    | 801-1000  | -                | B2   | C2   | D2   | E2   | F2   | G2   | H2   | I2   |
|                    | 1001-1200 | -                | -    | C3   | D3   | E3   | F3   | G3   | H3   | I3   |
|                    | 1201-1400 | -                | -    | -    | D4   | E4   | F4   | G4   | H4   | I4   |

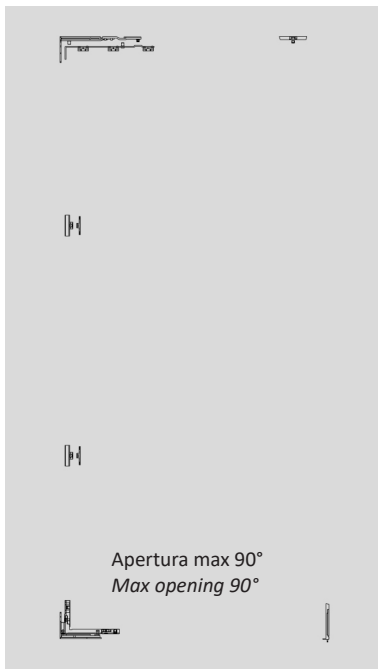
**Limiti dimensionali | Limits**Peso massimo anta | *Maximum leaf weight: 130 kg*misure cava ferramenta - H>L | *hardware measure - H>W***AGE 585.xx**

Meccanismo A/R seconda anta Dx cerniere a scomparsa

*Second leaf RH tilt-turn mechanism with concealed hinges*

EASY

**AGE 586.xx**

Meccanismo A/R seconda anta Sx cerniere a scomparsa

*Second leaf LH tilt-turn mechanism with concealed hinges*

EASY

|                    |           | altezza - height |      |      |      |      |      |      |      |      |
|--------------------|-----------|------------------|------|------|------|------|------|------|------|------|
|                    |           | 670              | 861  | 1001 | 1201 | 1401 | 1601 | 1801 | 2001 | 2201 |
|                    |           | 860              | 1000 | 1200 | 1400 | 1600 | 1800 | 2000 | 2200 | 2400 |
| larghezza<br>width | 601-800   | A1               | B1   | C1   | D1   | E1   | F1   | G1   | H1   | I1   |
|                    | 801-1000  | -                | B2   | C2   | D2   | E2   | F2   | G2   | H2   | I2   |
|                    | 1001-1200 | -                | -    | C3   | D3   | E3   | F3   | G3   | H3   | I3   |
|                    | 1201-1400 | -                | -    | -    | D4   | E4   | F4   | G4   | H4   | I4   |

**Limiti dimensionali | Limits**Peso massimo anta | *Maximum leaf weight: 130 kg*misure cava ferramenta - H>L | *hardware measure - H>W*

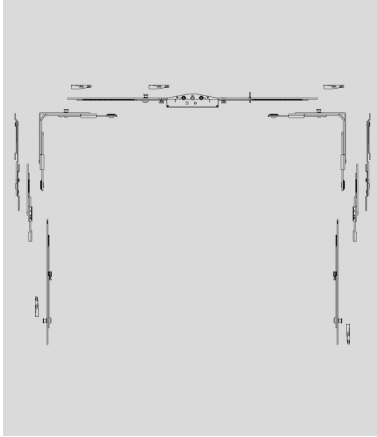
**AG 2574.xx**

Meccanismo vasistas con cremonese su traverso superiore

*Bottom hung window with cremonese bolt set on the top-rail*

**EASY**

altezza - height

|           |                 |            |            |             |             |
|-----------|-----------------|------------|------------|-------------|-------------|
|           |                 | <b>430</b> | <b>661</b> | <b>861</b>  | <b>1201</b> |
|           |                 | <b>660</b> | <b>860</b> | <b>1200</b> | <b>1400</b> |
| larghezza | <b>670-860</b>  | A2         | B2         | C2          | D2          |
| width     | <b>861-1200</b> | A3         | B3         | C3          | D3          |

**Limiti dimensionali | Limits**

Peso massimo anta | *Maximum leaf weight: 70-100 kg*

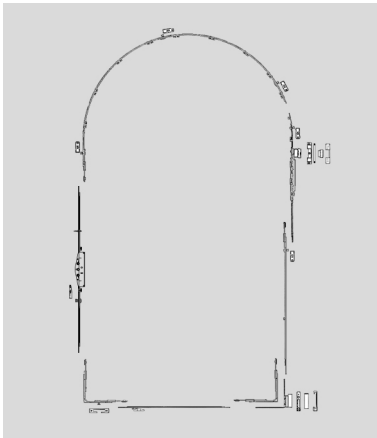
**AG 2578**

Meccanismo A/R curvo ad una o due ante con cerniere a vista (specificare all'ordine misure cava ferramenta e mano di apertura)

*Tilt-turn mechanism with visible hinges for arched windows (Specify hardware slot size and the opening)*

**EASY**

**Solo con profilo telaio PR2513**  
**Only with frame profile PR2513**

**Limiti dimensionali | Limits**

Peso massimo anta | *Maximum leaf weight: 80 kg*

Larghezza massima | *Maximum width: 1200 mm*

Altezza massima arco reale | *Maximum height arch: 1900 mm*

Altezza massima arco ribassato | *Maximum height segmental arch: 2400 mm*

**AG 1278C.xx**

Kit copertine destre in plastica per kit A/R AG 2578

*Plastic right-cover kit for tilt&turn for kit AG 2578*

AG127-C.AG argento | *matt silver*  
 AG127-C.MC marrone | *brown*  
 AG127-C.BC bronzato chiaro | *light bronze plated*  
 AG127-C.BO ottonato opaco | *matt brass plated*  
 AG127-C.OL ottonato lucido | *brass plated*  
 AG127-C.IS inox | *stainless steel*  
 AG127-C.NI nichelato | *nickel*  
 AG127-C.WB bianco RAL 9001 | *white RAL 9001*  
 AG127-C.WC bianco RAL 9010 | *white RAL 9010*

**AG 1279C.xx**

Kit copertine sinistre in plastica per kit A/R AG 2578

*Plastic left-cover kit for tilt&turn for kit AG 2578*

**AC 2801I**

Kit squadrette allineamento

*Alignment bracket set*

Profili | Profiles  
 PR2901 | PR2901 - PR2922  
 PR2901 - PR2903 | PR2901 - PR2905  
 PR2903 - PR2922 | PR2901 - PR2942  
 PR2903 - PR2942 | PR2905 - PR2942  
 PR2942 | PR2915 - P2942  
 PR2961 | PR2961 - PR2963  
 PR2962 - PR2963 telaio | frame

**AC 2805IR**

Kit squadrette allineamento

*Alignment bracket set*

Profili | Profiles  
 PR2505

**AC 2803I**

Kit squadrette allineamento

*Alignment bracket set*

Profili | Profiles  
 PR2903  
 PR2915  
 PR2963  
 PR2965 - PR2963

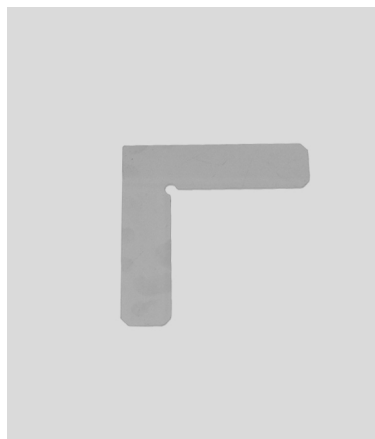
**AC 2811IR**

Kit squadrette allineamento

*Alignment bracket set*

Profili | Profiles  
 PR2511

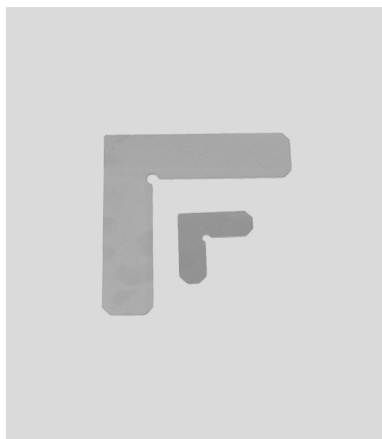
**AC 2803IR**

Kit squadrette allineamento

*Alignment bracket set*

Profili | Profiles  
 PR2503 | PR2513 | PR2542  
 PR2542 - 2543\*

\* Utilizzare solo la squadretta di allineamento esterna

*\*Use only the external alignment bracket*

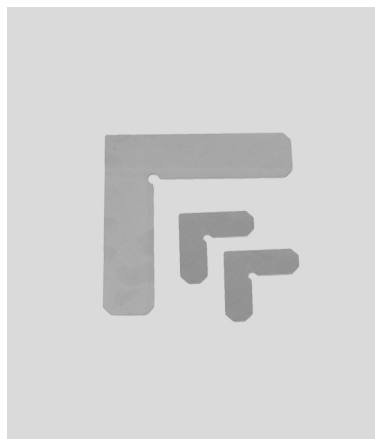
**AC 2815IR**

Kit squadrette allineamento

*Alignment bracket set*

Profili | Profiles  
 PR2515

**AC 2805I**

Kit squadrette allineamento

*Alignment bracket set*

Profili | Profiles  
 PR2905  
 PR2985

**AC 2822I**

Kit squadrette allineamento

*Alignment bracket set*

Profili | Profiles  
 PR2922  
 PR2905 - PR2922  
 PR2982  
 PR2985 - PR2982



**AC 2855I**

Kit squadrette allineamento

*Alignment bracket set*Profili | Profiles  
PR2955  
PR2974**AC 2872I**

Kit squadrette allineamento

*Alignment bracket set*Profili | Profiles  
PR2972**AC 2862I**

Kit squadrette allineamento

*Alignment bracket set*Profili | Profiles  
PR2962**AC 2875I**

Kit squadrette allineamento

*Alignment bracket set*Profili | Profiles  
PR2975**AC 2865I**

Kit squadrette allineamento

*Alignment bracket set*Profili | Profiles  
PR2965**AC 2891I**

Kit squadrette allineamento

*Alignment bracket set*Profili | Profiles  
PR2991**AC 2871I**

Kit squadrette allineamento

*Alignment bracket set*Profili | Profiles  
PR2971**AC 2892I**

Kit squadrette allineamento

*Alignment bracket set*Profili | Profiles  
PR2992  
PR2993

**AC 2855I**

Kit squadrette allineamento

*Alignment bracket set*Profili | Profiles  
PR2955  
PR2974**AC 2872I**

Kit squadrette allineamento

*Alignment bracket set*Profili | Profiles  
PR2972**AC 2862I**

Kit squadrette allineamento

*Alignment bracket set*Profili | Profiles  
PR2962**AC 2875I**

Kit squadrette allineamento

*Alignment bracket set*Profili | Profiles  
PR2975**AC 2865I**

Kit squadrette allineamento

*Alignment bracket set*Profili | Profiles  
PR2965**AC 2891I**

Kit squadrette allineamento

*Alignment bracket set*Profili | Profiles  
PR2991**AC 2871I**

Kit squadrette allineamento

*Alignment bracket set*Profili | Profiles  
PR2971**AC 2892I**

Kit squadrette allineamento

*Alignment bracket set*Profili | Profiles  
PR2992  
PR2993

**AC 2895I**

Kit squadrette allineamento

*Alignment bracket set*Profili | Profiles  
PR2995



**ACV 771.xx**

Martellina cremonese  
"VITRUVIO" small  
per finestra  
T | tonda | tronca

*Cremone handle  
small "VITRUVIO"  
for window  
T | cut | round*

BR ottone grezzo verniciabile | *paintable untreated brass*  
BB ottone brunito | *burnished brass*  
CL ottone cromo lucido | *polished and chromed brass*  
OL ottone lucido | *polished brass*  
SB acciaio inox scotch brite | *scotch-brite stainless steel*

**ACV 776.xx**

Martellina cremonese  
"VITRUVIO"  
per finestra  
KIDS

*Cremone handle  
small "VITRUVIO"  
for window  
KIDS*

BR ottone grezzo verniciabile | *paintable untreated brass*  
BB ottone brunito | *burnished brass*  
CL ottone cromo lucido | *polished and chromed brass*  
OL ottone lucido | *polished brass*

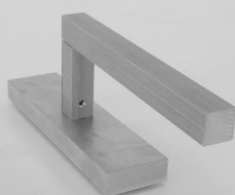
**ACV 772.xx**

Martellina cremonese  
"VITRUVIO" small  
per finestra  
L | quadra | tronca

*Cremone handle  
small "VITRUVIO"  
for window  
L | cut | square*

IZ inox grezzo verniciabile | *paintable stainless steel*  
CZ acciaio corten grezzo | *untreated corten steel*  
SB acciaio inox scotch brite | *scotch-brite stainless steel*

**ACV 777.xx**

Martellina cremonese  
"VITRUVIO"  
per finestra  
OVALE

*Cremone handle  
small "VITRUVIO"  
for window  
OVAL*

BR ottone grezzo verniciabile | *paintable untreated brass*  
BB ottone brunito | *burnished brass*  
CL ottone cromo lucido | *polished and chromed brass*  
OL ottone lucido | *polished brass*

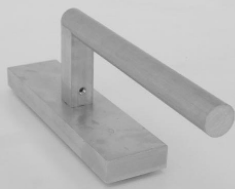
**ACV 773.xx**

Martellina cremonese  
"VITRUVIO" small  
per finestra  
L | tonda | tronca

*Cremone handle  
small "VITRUVIO"  
for window  
L | cut | round*

BR ottone grezzo verniciabile | *paintable untreated brass*  
BB ottone brunito | *burnished brass*  
CL ottone cromo lucido | *polished and chromed brass*  
OL ottone lucido | *polished brass*  
SB acciaio inox scotch brite | *scotch-brite stainless steel*

**ACV 779.xx**

Martellina cremonese  
"VITRUVIO" small  
per finestra  
T | tonda | sfera

*Cremone handle  
small "VITRUVIO"  
for window  
T | sphere | round*

BR ottone grezzo verniciabile | *paintable untreated brass*  
BB ottone brunito | *burnished brass*  
CL ottone cromo lucido | *polished and chromed brass*  
OL ottone lucido | *polished brass*

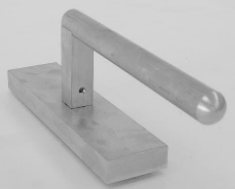
**ACV 774.xx**

Martellina cremonese  
"VITRUVIO" small  
per finestra  
L | tonda | sfera

*Cremone handle  
small "VITRUVIO"  
for window  
L | sphere | round*

BR ottone grezzo verniciabile | *paintable untreated brass*  
BB ottone brunito | *burnished brass*  
CL ottone cromo lucido | *polished and chromed brass*  
OL ottone lucido | *polished brass*

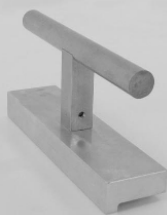
**ACV 781.xx**

Martellina cremonese  
"VITRUVIO" small  
per finestra ad un'anta  
PR2933

T | tonda | tronca

*Cremone handle  
small "VITRUVIO"  
for single leaf window  
PR2933*

T | cut | round

BR ottone grezzo verniciabile | paintable untreated brass  
BB ottone brunito | burnished brass  
CL ottone cromo lucido | polished and chromed brass  
OL ottone lucido | polished brass  
SB acciaio inox scotch brite | scotch-brite stainless steel

**ACV 786.xx**

Martellina cremonese  
"VITRUVIO" small  
per finestra a un'anta  
PR2933

KIDS

*Cremone handle  
small "VITRUVIO"  
for single leaf window  
PR2933*

KIDS

BR ottone grezzo verniciabile | paintable untreated brass  
BB ottone brunito | burnished brass  
CL ottone cromo lucido | polished and chromed brass  
OL ottone lucido | polished brass

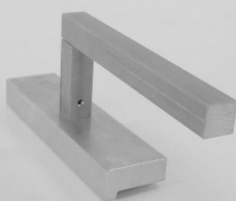
**ACV 782.xx**

Martellina cremonese  
"VITRUVIO" small  
per finestra a un'anta  
PR2933

L | quadra | tronca

*Cremone handle  
small "VITRUVIO"  
for single leaf window  
PR2933*

L | cut | square

IZ inox grezzo verniciabile | paintable stainless steel  
CZ acciaio corten grezzo | untreated corten steel  
SB acciaio inox scotch brite | scotch-brite stainless steel

**ACV 787.xx**

Martellina cremonese  
"VITRUVIO" small  
per finestra a un'anta  
PR2933

OVALE

*Cremone handle  
small "VITRUVIO"  
for single leaf window  
PR2933*

OVAL

BR ottone grezzo verniciabile | paintable untreated brass  
BB ottone brunito | burnished brass  
CL ottone cromo lucido | polished and chromed brass  
OL ottone lucido | polished brass

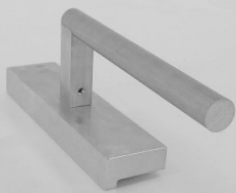
**ACV 783.xx**

Martellina cremonese  
"VITRUVIO" small  
per finestra a un'anta  
PR2933

L | tonda | tronca

*Cremone handle  
small "VITRUVIO"  
for single leaf window  
PR2933*

L | cut | round

BR ottone grezzo verniciabile | paintable untreated brass  
BB ottone brunito | burnished brass  
CL ottone cromo lucido | polished and chromed brass  
OL ottone lucido | polished brass  
SB acciaio inox scotch brite | scotch-brite stainless steel

**ACV 789.xx**

Martellina cremonese  
"VITRUVIO" small  
per finestra a un'anta  
PR2933

T | tonda | sfera

*Cremone handle  
small "VITRUVIO"  
for single leaf window  
PR2933*

T | sphere | round

BR ottone grezzo verniciabile | paintable untreated brass  
BB ottone brunito | burnished brass  
CL ottone cromo lucido | polished and chromed brass  
OL ottone lucido | polished brass

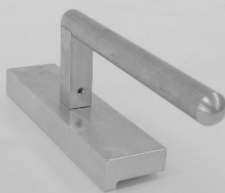
**ACV 784.xx**

Martellina cremonese  
"VITRUVIO" small  
per finestra a un'anta  
PR2933

L | tonda | sfera

*Cremone handle  
small "VITRUVIO"  
for single leaf window  
PR2933*

L | sphere | round

BR ottone grezzo verniciabile | paintable untreated brass  
BB ottone brunito | burnished brass  
CL ottone cromo lucido | polished and chromed brass  
OL ottone lucido | polished brass

**AC 2556**

Meccanismo DK esterno per maniglie "Vitruvio"

*External tilt and turn mechanism for "Vitruvio" handles*

**ACV 673.xx**

Copertina per gratz con maniglia removibile su kit  
AC2624E | AC2625E  
AC2683E | AC2684E

*Cover for gratz mechanism on kit*  
AC2624E | AC2625E  
AC2683E | AC2684E

BR ottone grezzo verniciabile | *paintable untreated brass*  
BB ottone brunito | *burnished brass*  
CZ acciaio corten grezzo | *untreated corten steel*  
SB acciaio inox scotch brite | *scotch-brite stainless steel*

**ACR 055**

Quadro riduzione per martellina DK commerciale

*Spindle reducer for commercial DK handle*

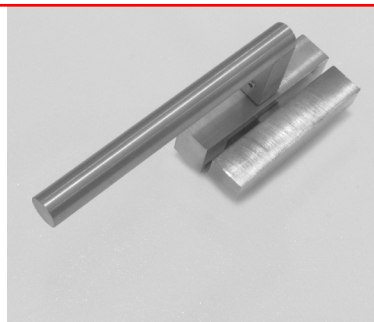
**ACV 793.xx.D**

Martellina per sporgere dx "VITRUVIO" small  
L | tonda | tronca  
RH Cockspar handle  
"VITRUVIO" small  
L | round | cut

**ACV 793.xx.S**

Martellina per sporgere sx "VITRUVIO" small  
L | tonda | tronca  
LH Cockspar handle  
"VITRUVIO" small  
L | round | cut

BR ottone grezzo verniciabile | *paintable untreated brass*  
BB ottone brunito | *burnished brass*  
SB acciaio inox scotch brite | *scotch-brite stainless steel*

**ACV 065**

Quadro maniglia

*Handle spindle bar*

**ACV 658.xx**

Copertina per gratz con maniglia removibile su kit  
AC2623E

*Cover for gratz mechanism on kit*  
AC2623E

BR ottone grezzo verniciabile | *paintable untreated brass*  
BB ottone brunito | *burnished brass*  
CZ acciaio corten grezzo | *untreated corten steel*  
SB acciaio inox scotch brite | *scotch-brite stainless steel*

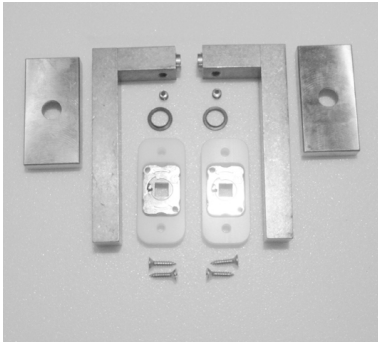
**ACV 952.xx**

Coppia maniglie per porta  
"VITRUVIO" medium  
bocchetta rettangolare  
L | quadra | tronca

*Double door handlesets  
"VITRUVIO" medium  
rectangular escutcheon  
L | square | cut*

IZ inox grezzo verniciabile | *paintable stainless steel*  
CZ acciaio corten grezzo | *untreated corten steel*  
SB acciaio inox scotch brite | *scotch-brite stainless steel*

**ACV 953.xx**

Coppia maniglie per porta  
"VITRUVIO" medium  
bocchetta rettangolare  
L | tonda | tronca

*Double door handlesets  
"VITRUVIO" medium  
rectangular escutcheon  
L | round | cut*

BR ottone grezzo verniciabile | *paintable untreated brass*  
BB ottone brunito | *burnished brass*  
CL ottone cromo lucido | *polished and chromed brass*  
OL ottone lucido | *polished brass*  
SB acciaio inox scotch brite | *scotch-brite stainless steel*

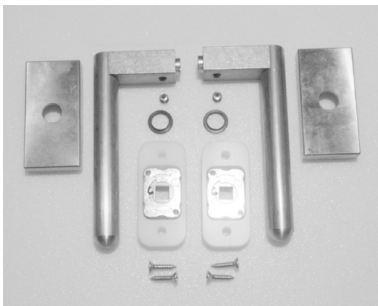
**ACV 954.xx**

Coppia maniglie per porta  
"VITRUVIO" medium  
bocchetta rettangolare  
L | tonda | sfera

*Double door handlesets  
"VITRUVIO" medium  
rectangular escutcheon  
L | round | sphere*

BR ottone grezzo verniciabile | *paintable untreated brass*  
BB ottone brunito | *burnished brass*  
CL ottone cromo lucido | *polished and chromed brass*  
OL ottone lucido | *polished brass*

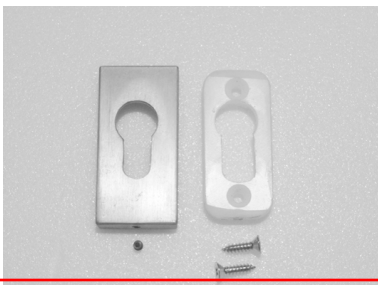
**ACV 964.xx**

Bocchetta copri cilindro a profilo europeo

*Euro profile cylinder escutcheon  
plate*

BR ottone grezzo verniciabile | *paintable untreated brass*  
BB ottone brunito | *burnished brass*  
CL ottone cromo lucido | *polished and chromed brass*  
OL ottone lucido | *polished brass*  
CZ acciaio corten grezzo | *untreated corten steel*  
SB acciaio inox scotch brite | *scotch-brite stainless steel*

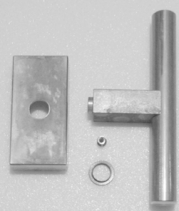

**ACV 971.xx**

Maniglia per DK  
finestra "VITRUVIO" medium  
T | tonda | tronca

*DK window handle*  
"VITRUVIO" medium  
T | round | cut

BR ottone grezzo verniciabile | *paintable untreated brass*  
BB ottone brunito | *burnished brass*  
CL ottone cromo lucido | *polished and chromed brass*  
OL ottone lucido | *polished brass*  
SB acciaio inox scotch brite | *scotch-brite stainless steel*

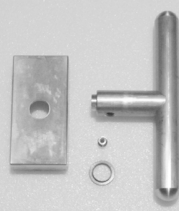
**ACV 976.xx**

Maniglia per DK finestra  
"VITRUVIO" medium  
KIDS

*DK window handle*  
"VITRUVIO" medium  
KIDS

BR ottone grezzo verniciabile | *paintable untreated brass*  
BB ottone brunito | *burnished brass*  
CL ottone cromo lucido | *polished and chromed brass*  
OL ottone lucido | *polished brass*

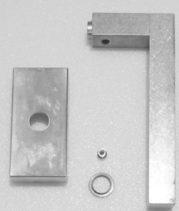
**ACV 972.xx**

Maniglia per DK finestra  
"VITRUVIO" medium  
L | quadra | tronca

*DK window handle*  
"VITRUVIO" medium  
L | square | cut

IZ inox grezzo verniciabile | *paintable stainless steel*  
CZ acciaio corten grezzo | *untreated corten steel*  
SB acciaio inox scotch brite | *scotch-brite stainless steel*

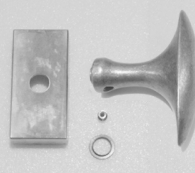
**ACV 977.xx**

Maniglia per DK finestra  
"VITRUVIO" medium  
OVALE

*DK window handle*  
"VITRUVIO" medium  
OVALE

BR ottone grezzo verniciabile | *paintable untreated brass*  
BB ottone brunito | *burnished brass*  
CL ottone cromo lucido | *polished and chromed brass*  
OL ottone lucido | *polished brass*

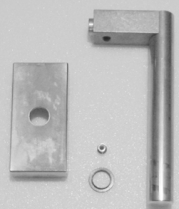
**ACV 973.xx**

Maniglia per DK finestra  
"VITRUVIO" medium  
L | tonda | tronca

*DK window handle*  
"VITRUVIO" medium  
L | round | cut

BR ottone grezzo verniciabile | *paintable untreated brass*  
BB ottone brunito | *burnished brass*  
CL ottone cromo lucido | *polished and chromed brass*  
OL ottone lucido | *polished brass*  
SB acciaio inox scotch brite | *scotch-brite stainless steel*

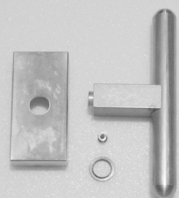
**ACV 979.xx**

Maniglia per DK finestra  
"VITRUVIO" medium  
T | tonda | sfera

*DK window handle*  
"VITRUVIO" medium  
T | round | sphere

BR ottone grezzo verniciabile | *paintable untreated brass*  
BB ottone brunito | *burnished brass*  
CL ottone cromo lucido | *polished and chromed brass*  
OL ottone lucido | *polished brass*

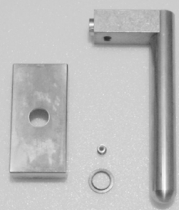
**ACV 974.xx**

Maniglia per DK finestra  
"VITRUVIO" medium  
L | tonda | sfera

*DK window handle*  
"VITRUVIO" medium  
L | round | sphere

BR ottone grezzo verniciabile | *paintable untreated brass*  
BB ottone brunito | *burnished brass*  
CL ottone cromo lucido | *polished and chromed brass*  
OL ottone lucido | *polished brass*



# METALFORM

MASTERS OF METAL

**UNITED KINGDOM**

**METALFORM**

**NORWAYMETAL LTD**

53 Chelsea Manor Street

London, SW3 5RZ

**SALES@METALFORM.UK**

**+44 20 81298814**

**GERMANY**

**METALFORM GMBH**

Carl-Zeiss-Ring 15A

85737 Ismaning

**SALES@METALFORMGROUP.DE**

**+49 17663630406**

**NORWAY**

**METALFORM AS**

Brochmannsveien 2

1950 Rømskog

**SALG@METALFORM.NO**

**+47 401 62 446**

**METALFORMGROUP**

**SALES@METALFORMGROUP.COM**