



## BB103-G

solid sprung door handle on rose

### Product information

Code: 3301D004NMXX0

Finish: satin black

UNIT: Pair

Collection: TENSE

Designer: Bertram Beerbaum

EAN code: 8718009299432

### TENSE by Bertram Beerbaum

The TENSE series is a total concept collection consisting of door, window, and furniture fittings.

### Finishes

- satin stainless steel
- satin black
- bronze

# TENSE BB103 G

lever handle  
stainless steel

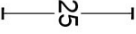
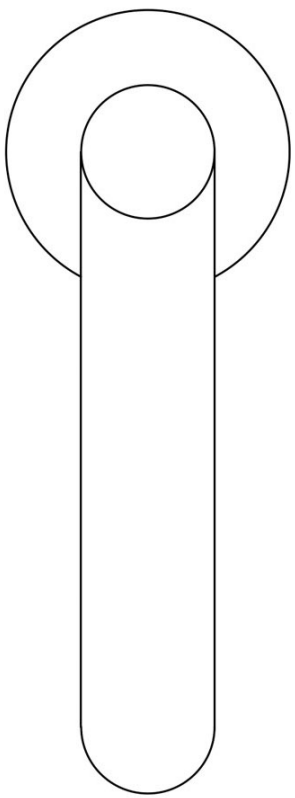
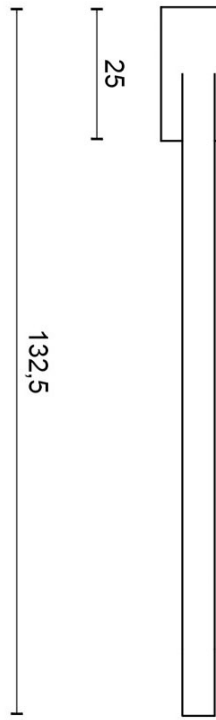
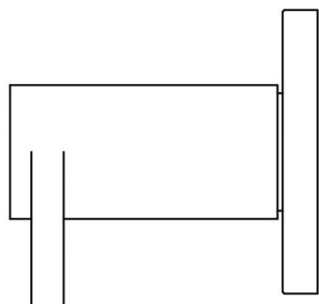
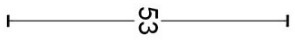
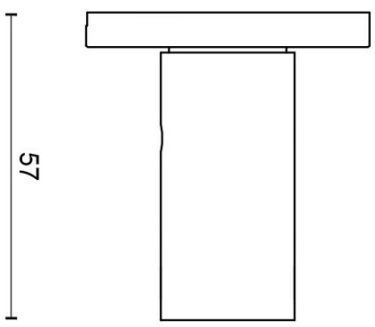
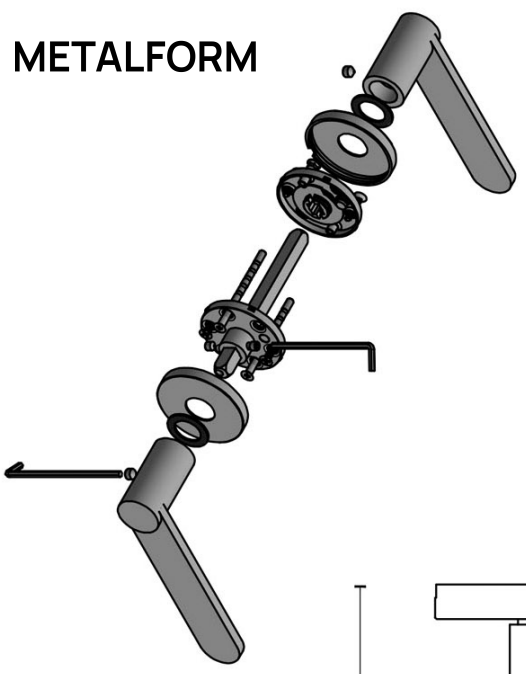

## METALFORM

<b>FORMANI®</b>		Part number:
Doc no.:	3301D004 TENSE BB103G V01.dwg	Description:
Drawn by:	Christian Brimbois	<b>TENSE BB103 G</b>
Creation date:	17-12-2015	Format:
FORMANI HOLLAND B.V. - EUROPALAAN 12 6199 AB MAASTRICHT-AIRPORT NL T +31 (0)43 308 90 00 INFO@FORMANI.COM FORMANI.COM		<b>A3</b>

# TENSE

by Bertram Beerbaum

**Designed by Bertram Beerbaum, our TENSE hardware series is guided by a clean aesthetic that is as robust as it is chic. Every design in the series is unique while at the same time bearing the unmistakable TENSE signature. The core of every design is the cylindrical neck to which each rectangular lever is connected in its own unique way. This is thanks to our extreme high precision welding technique, which forms a secure joint between two very different shapes. The unique characteristics of the design received an honorable mention during the German Design Awards, one of the most prestigious design contests. TENSE by Bertram Beerbaum is a total concept collection including door, window, and furniture fittings and is available in the colours stainless steel, satin black, and bronze.**

# TENSE

by Bertram Beerbaum

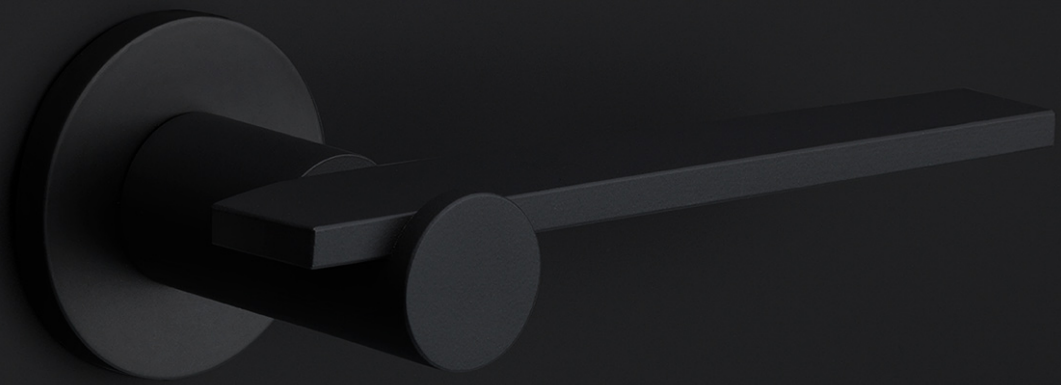

METALFORM  
FORMANI®



# Bertram Beerbaum

Hilversum, 1976

Design philosophy: I prefer to design a product that combines design and convenience in a natural way. Any product that I design must be something tough, chic, timeless and a tad own wisdom in them. Functional products with a surprising twist.

**Bertram Beerbaum prefers to design products in a convenient but natural way. Any product that he designs must be stylish, chic, and timeless, yet refreshingly idiosyncratic. These are products that combine function with a surprising twist. According to his design philosophy, door fittings must both look good and have a comfortable grip. But most importantly, the design should be in perfect harmony with the building's architecture. An inspiring encounter with Bertram Beerbaum generated innovative and exciting ideas and ultimately resulted in the introduction of the fantastic TENSE collection..**

**METALFORM  
FORMANI®**

# Brand story

**FORMANI has evolved considerably over the last few decades – from a Dutch family business to an internationally renowned designer brand, from door handles to total design concepts, from product development to collaborations with world-class designers. It was an evolution driven by pure ambition and courage. Our motto, ‘Obsessed with details’, epitomizes everything we do, from product to process, from strategy to service. Because it is these details that make the difference between good and perfect. At FORMANI, good is the enemy of great.**

---

Formani Holland b.v.  
Europalaan 12  
6199 AB  
Maastricht-Airport

T: +31(0)43 308 9000  
E: [info@formani.com](mailto:info@formani.com)

Chamber of Commerce:  
146 27 479

**METALFORM  
FORMANI®**

# METALFORM

MASTERS OF METAL

**UNITED KINGDOM**

**METALFORM**

**NORWAYMETAL LTD**

53 Chelsea Manor Street

London, SW3 5RZ

**SALES@METALFORM.UK**

**+44 20 81298814**

**GERMANY**

**METALFORM GMBH**

Carl-Zeiss-Ring 15A

85737 Ismaning

**SALES@METALFORMGROUP.DE**

**+49 17663630406**

**NORWAY**

**METALFORM AS**

Brochmannsveien 2

1950 Rømskog

**SALG@METALFORM.NO**

**+47 401 62 446**

**METALFORMGROUP**

**SALES@METALFORMGROUP.COM**