

MasterLine

Windows

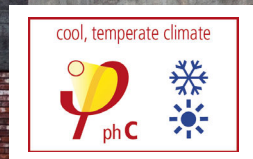

Windows.
Doors.
Façades.

METALFORM

Together for better

www.reynaers.com

Our partners' window solution of choice

MasterLine can do it all. The high-quality window series offers reliable AWW performance, versatile design options, and improved production speed. Enjoy excellent results, even in the toughest weather conditions.

Multiple insulation variants of the robust system provide a sustainable upgrade to any project.

MasterLine 10 High Insulation + windows are even Passive House Certified.

With MasterLine windows, you always create a clean and aesthetic finish. The profiles are easy to assemble, combine swiftly with other Reynaers Aluminium solutions, and come in different system variants. The countless design options and finishes allow you to create one-of-a-kind, high-rise-ready windows that meet all your building needs.



Flagship product with strong pedigree.

MasterLine is the most trusted window solution among Reynaers Aluminium professionals worldwide. It has been built upon for years to offer superior performance levels and futureproof design today. Fully compatible with our façade and door solutions, these versatile windows are both easy to produce and install, guaranteeing first-time-right results without exception.



Clean look.

If you are looking for clean aesthetics, then MasterLine is your perfect choice. The robust windows showcase a high level of finishing, with attention to detail in every component. Their straightforward, versatile design makes MasterLine the perfect fit for any type of project, for any architectural style. It offers a window of opportunity to all your challenges.



Ultimate combination of performance and aesthetics.

No need to compromise on performance or design. These high-quality windows always perform, even when facing extreme heat or cold, heavy rain, or tough winds at coastal areas. For example, MasterLine 8 offers the best acoustic performance in the market to ensure ultimate comfort at all times. Its multiple insulation variants, opening types, and accessories offer even more customisation options to choose from.

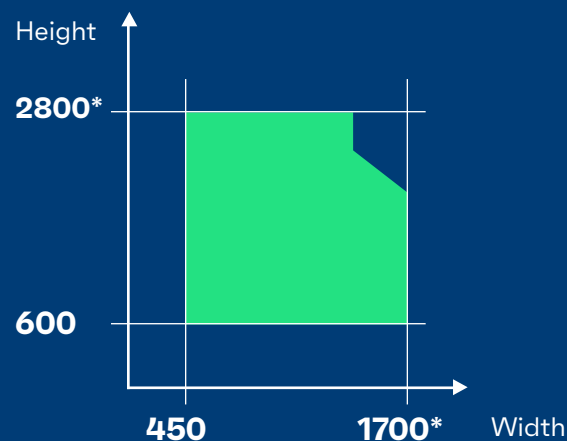

MasterLine Windows General

Possible vent sizes (mm)



*Max dimensions depend on multiple parameters including wind load requirements and glass type choice.

Max. vent weights (kg)

		
Tilt-turn	Turn	Fixed
200	300	1200

Visible dimensions (mm)

Inward opening window

1	Min. frame width	53
2	Min. vent width	37
3	Frame depth	77
4	Vent depth	87
5	Glass thickness	Up to 72

METALFORM

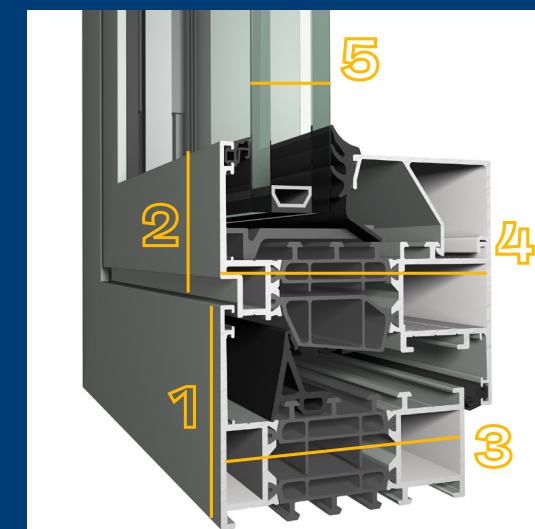

MasterLine Windows Variants

MasterLine 8 Functional

Thermal value - Uf (W/m²K)	Down to 1.0
Water tightness	E1200 (1200 Pa)
Wind load resistance	C5 (2000 Pa)
Burglarproof	RC3 (EN 1627) / PAS 24



**Performances and properties depend on size, profile combinations, hardware and infill

MasterLine 8 Ventilation Vent

Thermal value - Uf (W/m²K)	Down to 1.0
Water tightness	E1500 (1500 Pa)
Wind load resistance	C5 (2000 Pa)
Burglarproof	RC2 (EN 1627)



MasterLine 10 High Insulation +



Thermal value - Uf (W/m²K)	Down to 0.73
Water tightness	E900 (900 Pa)
Wind load resistance	C4 (1600 Pa)
Burglarproof	RC2 (EN 1627)

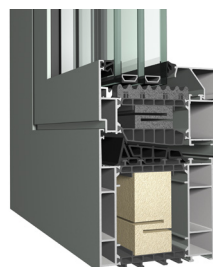

More variants can be found on our website...

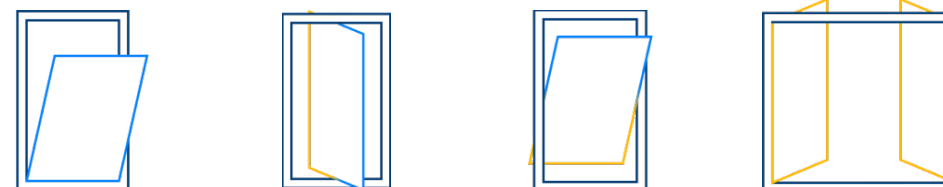

MasterLine Windows Options



Glass corner

Our glass-to-glass joinery connections enable wide panoramas without profiles obstructing your view. High-quality performance and unique design guaranteed in one solution.



Concealed drainage

Thanks to this concealed drainage solution, you no longer need plastic cover caps to hide drainage holes. As a result, you always enjoy clean lines, minimalistic design, and excellent performance as the water flows away.

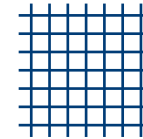

Flyscreen

We offer flyscreens in two variants: traditional & visible, or integrated & concealed flyscreens. Often overlooked at first, it is one of the most popular options amongst our customers.



Glass balustrade

Safety can equal beauty. We enhance our windows with this elegant glass barrier to avoid accidents, especially in high-rise buildings. Residents can still let in a fresh breath of air, without any worries.



Sustainability

MasterLine windows are known for their high thermal performance, answering all of your energy efficiency requirements. For example, MasterLine High Insulation + windows are Passive House certified, reaching U_f levels down to $0.73 \text{ W/m}^2\text{K}$. Aluminium is always a responsible choice, as it can be 100% recycled without loss of quality. Recently, MasterLine 8's innovative design, with low-carbon insulatory materials, has led to its Cradle to Cradle® certification.



Smart Buildings

Our window systems are compatible with the industry's leading smart building systems. Through a range of intelligent solutions, our systems do the work for you at the push of a button. Open and close hard-to-reach windows with the help of a switch or your smartphone device, and enjoy some additional peace of mind thanks to our motorised solutions. Ask your Reynaers Aluminium representative for more details.

Get in touch

Interested or looking for more in-depth technical information? Contact your Reynaers Aluminium representative for more information or scan the QR code to visit our website.



METALFORM

MASTERS OF METAL

UNITED KINGDOM

METALFORM

NORWAYMETAL LTD

53 Chelsea Manor Street

London, SW3 5RZ

SALES@METALFORM.UK

+44 20 81298814

GERMANY

METALFORM GMBH

Carl-Zeiss-Ring 15A

85737 Ismaning

SALES@METALFORMGROUP.DE

+49 17663630406

NORWAY

METALFORM AS

Brochmannsveien 2

1950 Rømskog

SALG@METALFORM.NO

+47 401 62 446

METALFORMGROUP

SALES@METALFORMGROUP.COM