

# Jansen-Economy 60 Türen

Türen aus Stahl

# Portes Jansen-Economy 60

Portes en acier

# Jansen-Economy 60 doors

Doors in steel

Grafische Planungsdaten wie z.B. Anwendungsbeispiele, Konstruktionsdetails, Anschlüsse am Bau, die in unseren physischen oder elektronischen Dokumentationsunterlagen enthalten sind, sind schematische Darstellungen. Gleiches gilt für digitale Medien wie CAD Dateien oder BIM Modelle.

Sie sollen den ausführenden Metallbauer und/oder Fachplaner bei der Planung und Ausführung eines Projektes unterstützen. Sie sind im konkreten Anwendungsfall durch den ausführenden Metallbauer und/oder Fachplaner auf die Verwendbarkeit im konkreten betroffenen Projekt hinsichtlich rechtlichen/regulatorischen aber auch technischen objektspezifischen Anforderungen zu überprüfen und ggfs. eigenverantwortlich anzupassen.

Bei der Überprüfung, der spezifischen Planung und der Umsetzung sind die objektspezifischen Rahmenbedingungen (Material der Bausubstanz, Dimension des Einbauelements, Farbe, Exposition, Lasteinwirkung, etc.) sowie der geltende Stand der Technik einschliesslich aller anwendbaren Normen und technischen Richtlinien eigenverantwortlich zu beachten.

Falls das vorliegende Dokument Differenzen zur aktuellen deutschen Version (Artikel Nr. K1214237) aufweist, gilt in jedem Fall der deutsche Originaltext in der jeweils geltenden Fassung im Jansen Docu Center.

Alle Ausführungen dieser Dokumentation haben wir sorgfältig und nach bestem Wissen zusammengestellt. Wir können aber keine Verantwortung für die Benutzung der vermittelten Vorschläge und Daten übernehmen. Wir behalten uns technische Änderungen ohne Vorankündigung vor.

Les données de planification graphiques, comme les exemples d'application, détails de construction et raccordements au bâtiment, fournies dans notre documentation physique et numérique sont des représentations schématiques. Il en va de même pour les médias numériques comme les fichiers CAD ou modèles BIM.

Leur but est de faciliter la planification et réalisation d'un projet par les constructeurs métalliques et/ou concepteurs. Concrètement, elles doivent être vérifiées par le constructeur métallique et/ou le concepteur et, le cas échéant, modifiées de son propre chef pour s'assurer qu'elles concordent avec le projet concerné et qu'elles répondent aux exigences techniques spécifiques ainsi qu'aux dispositions légales et réglementaires.

Lors de la vérification, de la planification spécifique et de la mise en œuvre, il y a lieu de tenir compte des conditions spécifiques à l'objet (matériaux du bâtiment, dimension de l'élément d'insert, couleur, exposition, effet de charge, etc.) ainsi que de l'état actuel de la technique, y compris toutes les normes et directives techniques applicables.

En cas de divergence entre le présent document et la version allemande (no d'article K1214237), c'est dans tous les cas le texte original allemand qui prévaut dans sa version actuelle disponible dans le Jansen Docu Center.

Nous avons apporté le plus grand soin à l'élaboration de cette documentation. Cependant, nous déclinons toute responsabilité pour l'utilisation faite de nos propositions et de nos données.

Nous nous réservons le droit de procéder à des modifications techniques sans préavis.

Graphical planning data such as application examples, construction details, connections on site that are contained in our physical or electronic documentation components are schematic representations. The same applies to digital media such as CAD files or BIM models.

They are intended to support the metal worker and/or design engineer in planning and executing projects. In the specific case of application they are to be checked by the metal worker and/or design engineer in terms of their usability in the specific project concerned with regard to legal/regulatory and technical property-specific requirements and adjusted if necessary at the latter's own responsibility.

The property-specific underlying conditions (construction material, dimensions of installation element, colour, exposure, load effect etc.) and current state of the art including all applicable norms and technical guidelines are to be taken into consideration at the metal worker and/or design engineer's own responsibility during the review, specific planning and implementation.

If there are any differences between this document and the current German version (item number K1214237), the latest version of the original German text in the Jansen Docu Center shall prevail.

All the information contained in this documentation is given to the best of our knowledge and ability. However, we decline all responsibility for the use made of these suggestions and data.

We reserve the right to effect technical modifications without prior warning.

<p><b>Inhaltsverzeichnis</b>  <b>Sommaire</b>  <b>Content</b></p>		<p>Jansen-Economy 60 Türen  Jansen-Economy 60 portes  Jansen-Economy 60 doors</p>
<p><b>Systemübersicht</b>  Merkmale  Leistungseigenschaften  Systemausführungen  Typenübersicht</p>	<p><b>Sommaire du système</b>  Caractéristiques  Caractéristiques de performance  Exécutions de système  Sommaire des types</p>	<p><b>Summary of system</b>  Characteristics  Performance characteristics  System versions  Summary of types</p> <p><b>2</b></p>
<p><b>Profilsortiment</b></p>	<p><b>Assortiment de profilé</b></p>	<p><b>Range of profiles</b></p> <p><b>14</b></p>
<p><b>Beispiele</b>  Schnittpunkte  Konstruktionsdetails  Anschlüsse am Bau</p>	<p><b>Exemples</b>  Coupes de détails  Détails de construction  Raccords au mur</p>	<p><b>Examples</b>  Section details  Construction details  Attachment to structure</p> <p><b>18</b></p>
<p><b>Leistungseigenschaften</b></p>	<p><b>Caractéristiques de performance</b></p>	<p><b>Performance characteristics</b></p> <p><b>36</b></p>







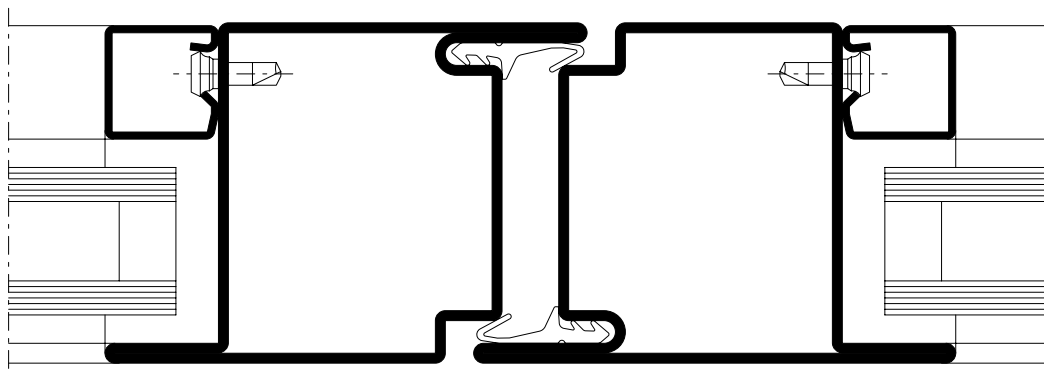

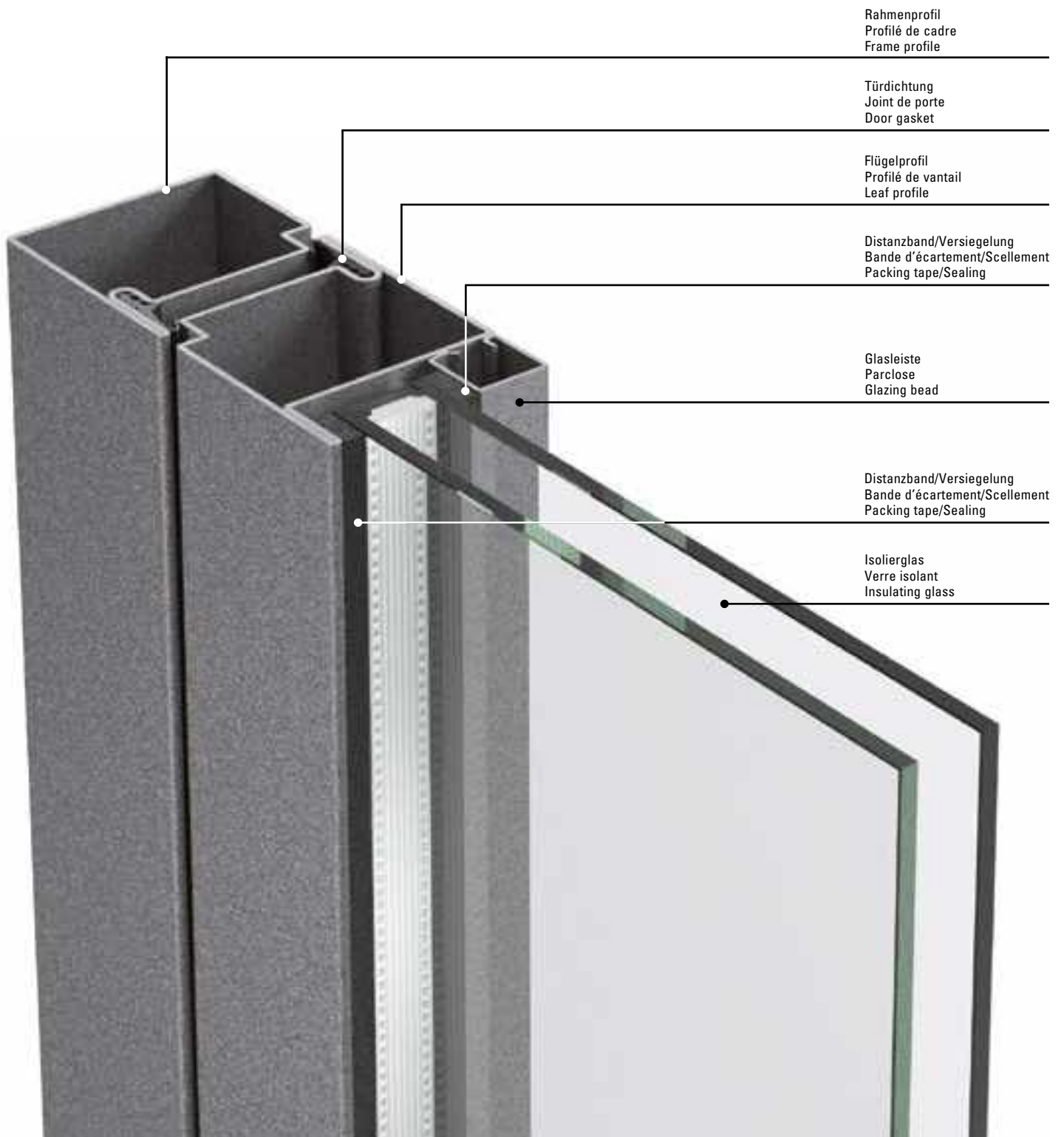

**Merkmale**  
**Caractéristiques**  
**Characteristics**





Jansen-Economy 60 Türen  
Jansen-Economy 60 portes  
Jansen-Economy 60 doors

- Stahlsystem für Türen und Festverglasungen
- Bautiefe 60 mm, innen und aussen flächenbündig
- Schmale Ansichtsbreiten: Rahmen und Flügel ab 105 mm Stulppartie 150 mm
- Ein- und zweiflüglige Türen, nach innen und aussen öffnend, mit Oberlicht oder Festverglasung kombinierbar
- Türflügel bis 1465 x 3000 mm (BxH), Flügelgewicht bis 230 kg
- Füllelementstärke von 5 bis 36 mm, Glaseinbau mittels Trocken- oder Nassverglasung
- Systemprüfungen nach Produktnorm EN 14351-1
- Stahlprofile blank oder bandverzinkt
- Grosses Sortiment an systemgeprüften Türbeschlägen
- Barrierefreie Schwellenausbildungen
- Geeignet für Pulver- und Nasslackbeschichtungen
- Système en acier pour portes et vitrages fixes
- Profondeur de montage 60 mm, montage à fleur à l'intérieur et à l'extérieur
- Fines largeurs de face: Cadre et vantaux à partir de 105 mm Partie tête 150 mm
- Portes à un et deux vantaux, ouverture vers l'intérieur et vers l'extérieur, combinables avec imposte ou vitrage fixe
- Vantaux de porte jusqu'à 1465 x 3000 mm (LaxH), poids du vantail jusqu'à 230 kg
- Élément de remplissage de 5 à 36 mm d'épaisseur, Montage du vitrage à sec ou à silicone
- Contrôles des systèmes selon la norme produit EN 14351-1
- Profilés en acier brut ou galvanisé en continu
- Grand assortiment de ferrures de porte homologuées
- Formes de seuil sans barrière
- Convient aux revêtements par poudre ou peinture liquide
- Steel system for doors and fixed glazing
- 60 mm basic depth, flush-fitted on the inside and outside
- Narrow face widths: Frame and leaf from 105 mm Meeting stile assembly 150 mm
- Single and double-leaf doors, inward and outward-opening, can be combined with toplight or fixed glazing
- Door leaf up to 1465 x 3000 mm (WxH), leaf weight up to 230 kg
- Infill unit thickness of 5 to 36 mm, Glazing installed by means of dry or wet glazing
- System tests in accordance with the product standard EN 14351-1
- Raw finish or pre-galvanised steel profiles
- Large range of system-tested door fittings
- Easy-access thresholds
- Suitable for powder and wet paint coating





Norm	Eigenschaft Caractéristique Characteristic	Klassifizierung/Wert Classification / Valeur Classification / Value											
 EN 12210	<b>Widerstandsfähigkeit bei Windlast</b> <b>Résistance à la pression du vent</b> <b>Resistance to wind load</b>	npd	1 (400)	2 (800)	3 (1200)	4 (1600)	5 (2000)	Exxx (>2000)					
 EN 12208	<b>Schlagregendichtheit</b> <b>Étanchéité à la pluie battante</b> <b>Watertightness</b>	npd	1A (0)	2A (50)	3A (100)	4A (150)	5A (200)	6A (250)	7A (300)	8A (450)	9A (600)	Exxx (>750)	
 EN ISO 10140	<b>Schalldämmung</b> $R_w$ (C, $C_{tr}$ ) (dB) <b>Isolation phonique</b> $R_w$ (C, $C_{tr}$ ) (dB) <b>Sound insulation</b> $R_w$ (C, $C_{tr}$ ) (dB)	npd	bis $R_w$ 44 dB (-2; -5) jusqu'à $R_w$ 44 dB (-2; -5) up to $R_w$ 44 dB (-2; -5)										
 EN ISO 10077-2	<b>Wärmedurchgangskoeffizient</b> $U_f$ (W/(m <sup>2</sup> ·K)) <b>Transmission thermique</b> $U_f$ (W/(m <sup>2</sup> ·K)) <b>Thermal production</b> $U_f$ (W/(m <sup>2</sup> ·K))	npd	ab 5.65 W/m <sup>2</sup> K à partir de 5.65 W/m <sup>2</sup> K from 5.65 W/m <sup>2</sup> K										
 EN 12207	<b>Luftdurchlässigkeit</b> <b>Perméabilité à l'air</b> <b>Air permeability</b>	npd	1 (150)		2 (300)		3 (600)		4 (600)				
 EN 1192	<b>Klassifizierung der Festigkeitsanforderungen</b> <b>Classification des exigences de résistance méc.</b> <b>Classification of strength requirements</b>	npd	1		2		3		4				
 EN 1627	<b>Einbruchhemmung</b> <b>Anti-effraction</b> <b>Burglar resistance</b>	npd	1		2		3		4		5		6
 EN 1522	<b>Durchschusshemmung</b> <b>Résistance aux balles</b> <b>Bullet proofing</b>	npd	FB1	FB2	FB3	FB4	FB5	FB6	FB7	FSG			
 EN 1191 EN 1603	<b>Dauerfunktionsprüfung</b> <b>Durabilité mécanique</b> <b>Mechanical durability</b>	D	1 5'000	2 10'000	3 20'000	4 50'000	5 100'000	6 200'000	7 500'000	8 1'000'000			
 EN 179 EN 1125	<b>Fähigkeit zur Freigabe</b> <b>Capacité au déclenchement</b> <b>Ability to release</b>		Anforderung erfüllt Exigence remplie Requirement fulfilled										

Norm	Eigenschaft Caractéristique Characteristic	Klassifizierung/Wert Classification / Valeur Classification / Value			
 EN 12217	<b>Bedienkräfte</b> <b>Forces de manœuvre</b> <b>Operating forces</b>	npd	0	1	2
 EN 1634-3 DIN 18095	<b>Rauchschutz</b> <b>Étanchéité à la fumée</b> <b>Smoke control</b>	S <sub>a</sub> / S <sub>200</sub> / RS			
 EN 16034 EN 13501-2	<b>Selbstschliessung</b> <b>Fermeture automatique</b> <b>Self-closing</b>	C			
 EN 16034	<b>Dauerhaftigkeit der Selbstschliessung gegenüber Alterung (Korrosion)</b> <b>Endurance de la fermeture automatique contre le vieillissement (corrosion)</b> <b>Durability of self-closing against ageing (corrosion)</b>	erzielt atteinte achieved			



### Einbruchhemmende Jansen-Economy 60 Türen

- Türflügelgrößen 1465 x 3000 mm
- Ein- und zweiflügelige Türen, nach innen und aussen öffnend
- Geprüft nach EN 1627
- Panik- und Normalausführung

### Portes anti-effraction Jansen-Economy 60

- Dimensions de vantail de porte 1465 x 3000 mm
- Portes à un/deux vantaux à ouverture vers l'intérieur et l'extérieur
- Contrôlé selon la norme EN 1627
- Exécution panique et exécution normale

### Burglar-resistant Jansen Economy 60 doors

- Door leaf sizes 1465 x 3000 mm
- Single and double-leaf doors, inward and outward opening
- Tested in accordance with EN 1627
- Panic and standard design



### Durchschusshemmende Jansen-Economy 60 Türen

- Türflügelgrößen 1465 x 3000 mm
- Ein- und zweiflügelige Türen, nach innen und aussen öffnend
- Geprüft nach EN 1522

### Portes pare-balles Jansen-Economy 60

- Dimensions de vantail de porte 1465 x 3000 mm
- Portes à un/deux vantaux à ouverture vers l'intérieur et l'extérieur
- Contrôlé selon la norme EN 1522

### Bullet-resistant Jansen Economy 60 doors

- Door leaf sizes 1465 x 3000 mm
- Single and double-leaf doors, inward and outward opening
- Tested in accordance with EN 1522





### **Fluchttürsysteme**

- Verschlussystem für Notausgangstüren nach EN 179
- Verschlussystem für Paniktüren nach EN 1125
- Barrierefreie Türen ohne Schwelle für behindertengerechtes Bauen
- Ein- und zweiflügelige Türen nach innen und aussen öffnend
- Türflügelgrößen bis 1465 x 3000 mm und Flügelgewicht bis 230 kg

### **Systèmes de porte de secours**

- Système de fermeture pour portes de secours selon EN 179
- Système de fermeture pour portes panique selon EN 1125
- Portes sans seuil pour faciliter l'accès aux personnes handicapées
- Portes à un/deux vantaux à ouverture vers l'intérieur et l'extérieur
- Dimensions de vantail de porte jusqu'à 1465 x 3000 mm et poids de vantail jusqu'à 230 kg

### **Emergency exit systems**

- Closing system for emergency exit doors in accordance with EN 179
- Closing system for panic doors in accordance with EN 1125
- Barrier-free doors without threshold for accessible buildings
- Single and double-leaf doors, inward and outward opening
- Door leaf sizes up to 1465 x 3000 mm and leaf weight up to 230 kg



### **Jansen-Economy 60 Fingerschutzüren**

- Keine Quetsch- und Scherstellen nach DIN 18650
- Wartungsarme Bandlager unten und oben
- Geeignet für Gebäude mit starkem Publikumsverkehr
- Geprüft nach EN 14351-1

### **Portes anti-pince-doigts Jansen-Economy 60**

- Absence de zones d'écrasement et de cisaillement selon DIN 18650
- Paliers de paumelle inférieur et supérieur exigeant peu de maintenance
- Adapté à des bâtiments publics fortement fréquentés
- Contrôlé selon la norme EN 14351-1

### **Jansen Economy 60 anti-finger-trap doors**

- No crushing and shearing points as per DIN 18650
- Low-maintenance hinge bush at top and bottom
- Suitable for buildings subject to frequent use by the public
- Tested in accordance with EN 14351-1



### Verblechte Jansen-Economy 60 Türen

- Flächenbündig verblechte Türen
- Geschweisst oder geklebt
- Nach innen und aussen öffnend
- Mit Glasausschnitt möglich

### Portes tôlées Jansen-Economy 60

- Portes tôlées à fleur
- Soudées ou collées
- Ouverture vers l'intérieur et l'extérieur
- Panneau de verre possible

### Jansen Economy 60 sheet metal doors

- Flush-fitted sheet metal doors
- Welded or bonded
- Inward and outward-opening
- Can have glass vision panel



### Jansen-Economy 60 Faltwand

- Nach innen und aussen öffnend
- Leichtgängige, geräuscharme Bedienung
- Schwellenlose Ausführung
- Flügelgewichte bis 100 kg

### Porte repliable Jansen-Economy 60

- Ouverture vers l'intérieur et l'extérieur
- Mobilité silencieuse
- Exécution sans seuil
- Poids de vantail jusqu'à 100 kg

### Jansen Economy 60 folding wall

- Inward and outward-opening
- Smooth and quiet operation
- Design without a threshold
- Vent weights up to 100 kg

## Jansen Docu Center

Die Plattform zum effizienten Arbeiten mit Jansen Dokumentationen. Im Jansen Docu Center stehen alle Produktinformationen jederzeit digital in der aktuellsten Version zur Verfügung: von Architekten-Informationen über Bestell- und Fertigungskatalogen bis hin zu Anleitungen und Prospekten sowie Videos.

Die Inhalte können einfach und schnell aufgerufen werden. Ein für den Anwender komfortables papierloses Arbeiten, das zahlreiche Vorteile bietet.

## Download CAD Daten

**DXF**

**DWG**

Sie können die Zeichnungen in den Formaten DXF und/oder DWG herunterladen. Klicken Sie auf das entsprechende Icon und der Download erfolgt.

Die Hinweise «Artikelbibliothek/Türbeschläge/Fensterbeschläge» bedeuten, dass Sie mit einem Klick die gesamte Artikelbibliothek des entsprechenden Systems herunterladen (Profile, Beschläge, Glasleisten, Zubehör etc.).

## Info und Beratung

Gerne beraten wir Sie persönlich und stehen Ihnen bei Fragen zur Verfügung. Bitte schreiben Sie uns Ihre Anliegen an: [info@jansen.com](mailto:info@jansen.com)

## Jansen Docu Center

La plate-forme pour travailler efficacement avec les documentations Jansen. Le Jansen Docu Center met à votre disposition les informations sur les produits, en format numérique et dans une version actualisée: des catalogues de commande et de fabrication aux instructions et prospectus, en passant par les informations destinées aux architectes et vidéos.

Les contenus sont facilement et rapidement accessibles. Une manière de travailler confortable et offrant de nombreux avantages.

## Télécharger fichiers DAO

**DXF**

**DWG**

Vous pouvez télécharger les dessins aux formats DXF et/ou DWG. Cliquez sur l'icône correspondante et le téléchargement s'effectuera.

Les indications «Bibliothèque des articles/Ferures de porte/Ferrures de fenêtres» signifie que vous téléchargez la totalité de la bibliothèque des articles du système donné (profilés, ferrures, parclozes, accessoires etc.).

## Info et conseils

Nous vous conseillerons volontiers individuellement et sommes à votre disposition si vous avez des questions à poser. Veuillez nous envoyer votre requête à: [info@jansen.com](mailto:info@jansen.com)

## Jansen Docu Center

The platform for working efficiently with Jansen documentation. The latest version of all the product information is available digitally at any time in the Jansen Docu Center – from order and fabrication manuals to architect information, instructions and brochures and videos.

The content can be retrieved quickly and easily. The user can work conveniently without paper, which has numerous benefits.

## Download CAD files

**DXF**

**DWG**

You can download the drawings in DXF and/or DWG format. Click on the relevant icon to begin the download.

The items «Article library/Door fittings/Window fittings» means that you download the entire article library for the corresponding system with one click (profiles, fittings, glazing beads, accessories etc.).

## Information and advice

We would be delighted to provide you with advice in person and are available to answer any questions you may have. Please write to us with your queries at: [info@jansen.com](mailto:info@jansen.com)

Zulassungen/Prüfungen  
Homologations/Essais  
Authorisations/Tests

Jansen-Economy 60 Türen  
Jansen-Economy 60 portes  
Jansen-Economy 60 doors

Elementgrößen  
(Empfehlung für CE-Kennzeichnung)

Dimensions des éléments  
(Recommandation pour le label CE)

Size of elements  
(Recommendation for CE marking)

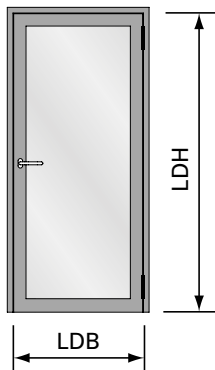

LDB Lichte Durchgangsbreite  
max. 1400 mm  
min. 490 mm

LDB Largeur vide lumière  
max. 1400 mm  
min. 490 mm

LDB Clear opening width  
max. 1400 mm  
min. 490 mm

LDH Lichte Durchgangshöhe  
max. 3000 mm  
min. 1900 mm

LDH Hauteur vide lumière  
max. 3000 mm  
min. 1900 mm

LDH Clear opening height  
max. 3000 mm  
min. 1900 mm

Flügelgewicht max. 230 kg

Poids de vantail max. 230 kg

Weight of leaf max. 230 kg

Zulassungen/Prüfungen  
Homologations/Essais  
Authorisations/Tests

Jansen-Economy 60 Türen  
Jansen-Economy 60 portes  
Jansen-Economy 60 doors

Elementgrößen  
(Empfehlung für CE-Kennzeichnung)

Dimensions des éléments  
(Recommandation pour le label CE)

Size of elements  
(Recommendation for CE marking)

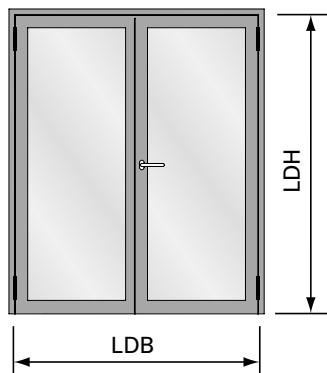

LDB Lichte Durchgangsbreite  
max. 2800 mm  
min. 1000 mm

LDB Largeur vide lumière  
max. 2800 mm  
min. 1200 mm

LDB Clear opening width  
max. 2800 mm  
min. 1000 mm

LDH Lichte Durchgangshöhe  
max. 3000 mm  
min. 1900 mm

LDH Hauteur vide lumière  
max. 3000 mm  
min. 1900 mm

LDH Clear opening height  
max. 3000 mm  
min. 1900 mm

Flügelgewicht max. 230 kg

Poids de vantail max. 230 kg

Weight of leaf max. 230 kg

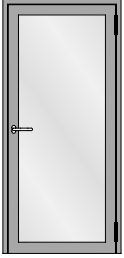

Einflügelige Türe  
Porte à un vantail  
Single leaf door

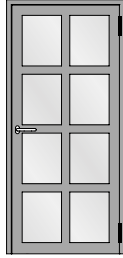

Einflügelige Türe mit Riegel  
Porte à un vantail avec traverse  
Single leaf door with transom

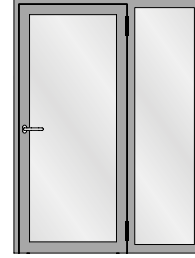

Einflügelige Türe mit Seitenteil  
Porte à un vantail avec partie latérale  
Single leaf door with side light

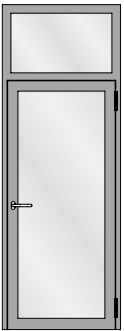

Einflügelige Türe mit Oberlicht  
Porte à un vantail avec imposte  
Single leaf door with top light

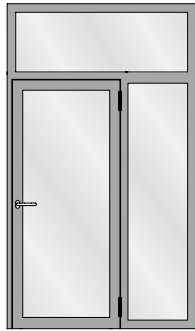

Einflügelige Türe mit Seitenteil und Oberlicht  
Porte à un vantail avec avec partie latérale  
et imposte  
Single leaf door with side light and top light

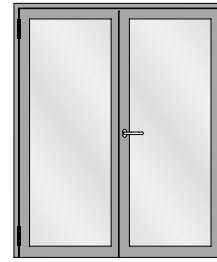

Zweiflügelige Türe  
Porte à deux vantaux  
Double leaf door



Zweiflügelige Türe mit zwei Seitenteilen  
Porte à deux vantaux avec deux parties latérales  
Double leaf door with two side lights

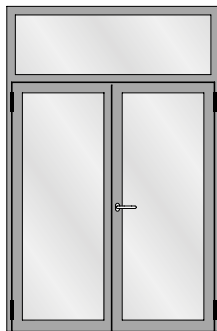

Zweiflügelige Türe mit Oberlicht  
Porte à deux vantaux avec imposte  
Double leaf door with top light

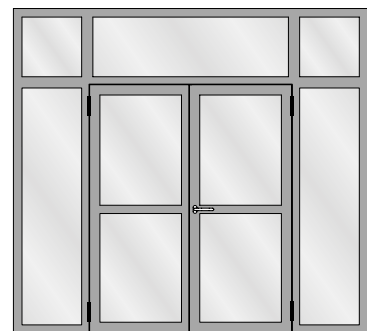

Zweiflügelige Türe mit zwei Seitenteilen und Oberlichtern  
Porte à deux vantaux avec deux parties latérales et impostes  
Double leaf door with two side lights and top lights

**Typenübersicht**  
**Sommaire des types**  
**Summary of types**

**Jansen-Economy 60 Türen**  
**Jansen-Economy 60 portes**  
**Jansen-Economy 60 doors**

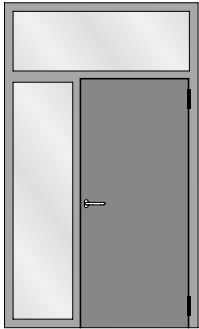

Verblechte Türe mit Seitenteil und Oberlicht  
Porte tôlée à un vantail avec avec partie latérale  
et imposte  
Sheet metal single leaf door with side light  
and top light



Verblechte zweiflügelige Türe mit zwei  
Seitenteilen und Oberlichtern  
Porte tôlée à deux vantaux avec deux parties  
latérales et impostes  
Sheet metal double leaf door with two side  
lights and top lights



Festverglasung  
Vitrage fixe  
Fixed glazing

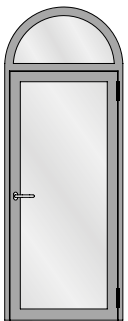

Einflügelige Türe mit Rundbogen-Oberlicht  
Porte à un vantail avec imposte demi-ronde  
Single leaf door with round arched top light

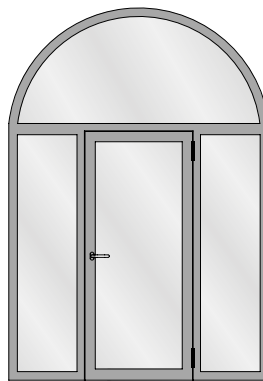

Einflügelige Türe mit zwei Seitenteilen und  
Rundbogen-Oberlicht  
Porte à un vantail avec deux parties latérales  
et imposte demi-ronde  
Single leaf door with two side lights and  
round arched top light

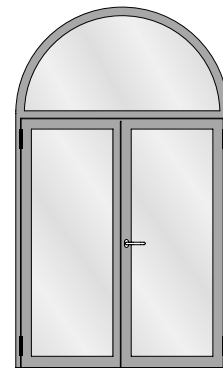

Zweiflügelige Türe mit Rundbogen-Oberlicht  
Porte à deux vantaux avec imposte demi-ronde  
Double leaf door with round arched top light

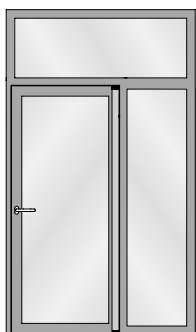

Fingerschutztüre  
Porte anti-pince-doigts  
Anti-finger-trap door

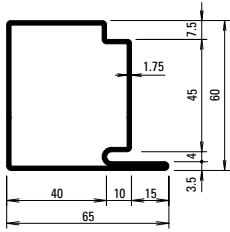

**30.019**  
**30.019 Z**

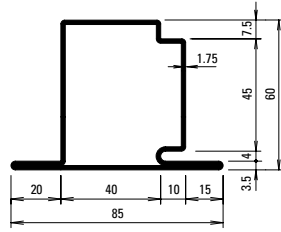

**30.119**  
**30.119 Z**

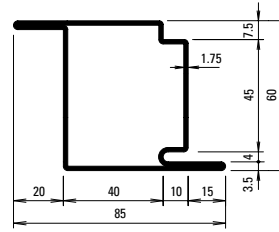

**30.419**  
**30.419 Z**

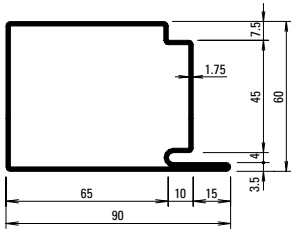

**30.017**  
**30.017 Z**

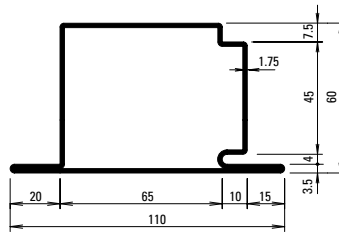

**30.117**  
**30.117 Z**

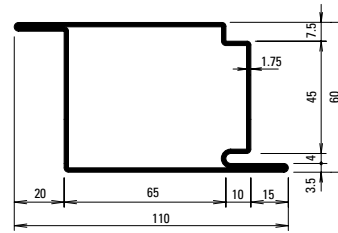

**30.415**

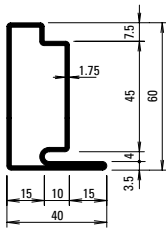

**30.018**  
**30.018 Z**

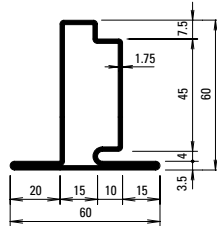

**30.118**  
**30.118 Z**

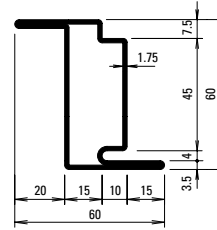

**30.418**  
**30.418 Z**

**Oberfläche/Werkstoff**

Artikel-Nr.

**ohne Zusatz** = blank

**mit Z** = bandverzinkter Stahl

**Surface/Matériau**

No. d'article

**sans supplément** = brut

**avec Z** = bande d'acier zinguée

**Surface/Material**

Part no.

**without addition** = bright

**with Z** = strip galvanised steel

Profil-Nr.	G kg/m	F cm <sup>2</sup>	I <sub>x</sub> cm <sup>4</sup>	W <sub>x</sub> cm <sup>3</sup>	I <sub>y</sub> cm <sup>4</sup>	W <sub>y</sub> cm <sup>3</sup>	U m <sup>2</sup> /m
<b>30.017</b>	4,200	5,36	31,32	9,09	48,57	10,35	0,312
<b>30.018</b>	2,830	3,61	15,95	4,35	4,77	1,93	0,212
<b>30.019</b>	3,520	4,48	23,69	6,70	19,75	5,55	0,262
<b>30.117</b>	4,750	6,04	34,75	9,35	65,74	11,51	0,350
<b>30.118</b>	3,370	4,29	18,64	4,65	8,26	2,75	0,250
<b>30.119</b>	4,050	5,16	26,80	6,99	29,12	6,58	0,300

Profil-Nr.	G kg/m	F cm <sup>2</sup>	I <sub>x</sub> cm <sup>4</sup>	W <sub>x</sub> cm <sup>3</sup>	I <sub>y</sub> cm <sup>4</sup>	W <sub>y</sub> cm <sup>3</sup>	U m <sup>2</sup> /m
<b>30.415</b>	4,750	6,04	37,79	12,28	65,74	11,51	0,350
<b>30.418</b>	3,370	4,29	22,92	7,37	8,62	2,75	0,250
<b>30.419</b>	4,050	5,16	30,36	9,82	29,12	6,58	0,300



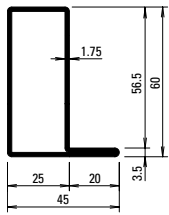

**01.634**  
**01.634 Z**

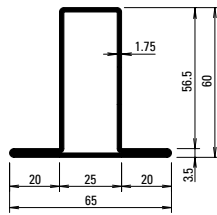

**02.634**  
**02.634 Z**

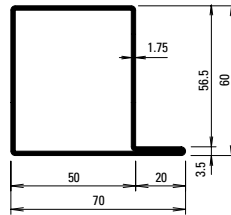

**01.684**  
**01.684 Z**

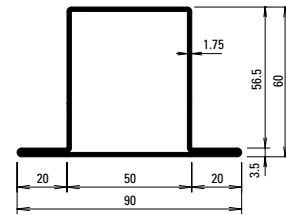

**02.684**  
**02.684 Z**

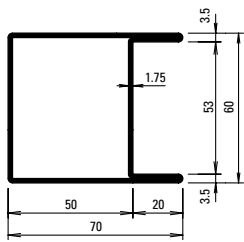

**04.637**  
**04.637 Z**

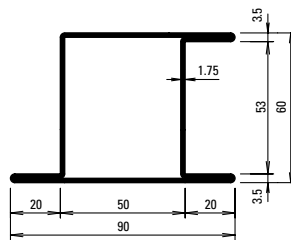

**05.637**  
**05.637 Z**

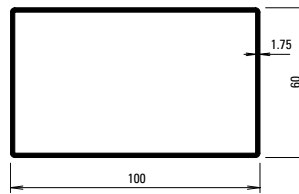

**400.051**  
**400.051 Z**

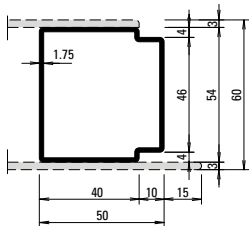

**81.010 Z**

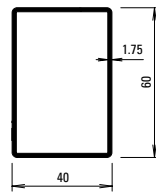

**400.052**  
**400.052 Z**

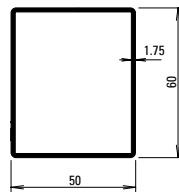

**400.054**  
**400.054 Z**

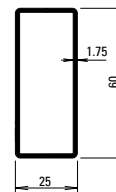

**400.055**  
**400.055 Z**

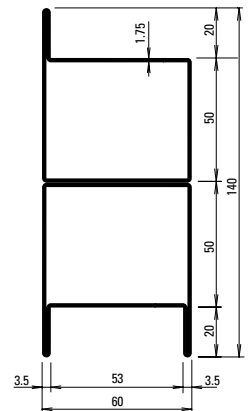

**05.001**

Profil-Nr.	G kg/m	F cm <sup>2</sup>	I <sub>x</sub> cm <sup>4</sup>	W <sub>x</sub> cm <sup>3</sup>	I <sub>y</sub> cm <sup>4</sup>	W <sub>y</sub> cm <sup>3</sup>	U m <sup>2</sup> /m
<b>01.634</b>	2,730	3,48	16,71	4,71	6,04	2,15	0,204
<b>02.634</b>	3,270	4,17	19,66	5,01	10,34	3,18	0,243
<b>01.684</b>	3,430	4,37	24,34	7,07	22,12	5,59	0,255
<b>02.684</b>	3,960	5,05	27,70	7,36	31,93	7,09	0,294
<b>04.637</b>	3,960	5,05	30,62	10,2	27,45	7,71	0,294
<b>05.637</b>	4,500	5,72	35,42	10,6	39,45	8,02	0,333
<b>81.010</b>	2,700	3,43	14,53	5,38	13,05	5,10	0,202
<b>400.051</b>	4,300	5,44	76,01	15,2	34,64	11,55	0,316
<b>400.052</b>	2,630	3,34	8,98	4,49	16,86	5,62	0,197
<b>400.054</b>	2,900	3,69	14,97	5,98	19,83	6,61	0,217
<b>400.055</b>	2,210	2,82	3,08	2,47	12,41	4,13	0,167

**Stabachse**  
**Axe de la barre**  
**Bar axis**

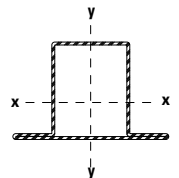

Artikelbibliothek  
 Bibliothèque des articles  
 Article library

**DXF** **DWG**

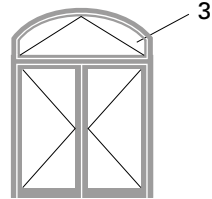
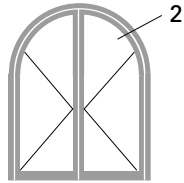
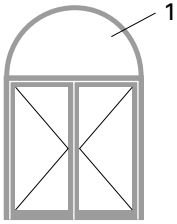

**1.0**

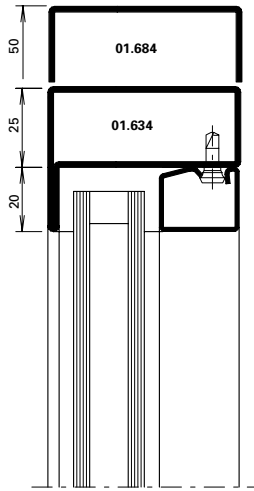

**2.0**

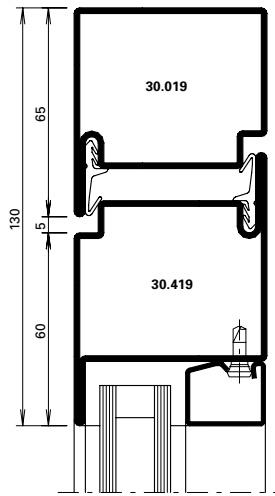

**3.0**

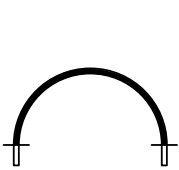
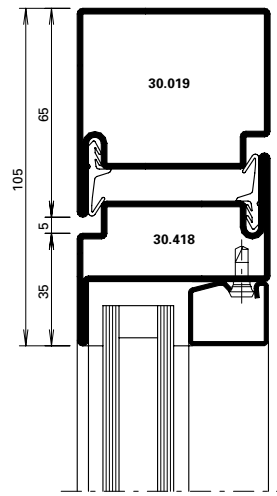

Halbrundbogen  
 Arc semi-circulaire  
 Semi-circular arch

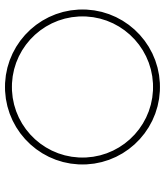

Rundbogen  
 Arc en plein centre  
 Round arch

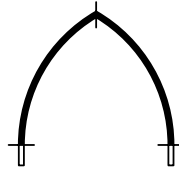

Spitzbogen  
 Ogive  
 Gothic arch



Stichbogen  
 Arc bombé  
 Segmented arch



Korbbogen  
 Anse de panier  
 Oval arch

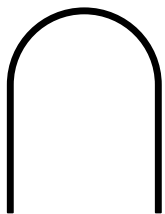

Halbrundbogen mit Schenkel  
 Arc surhaussé  
 Semi-circular arch with side extension

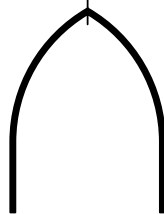

Spitzbogen mit Schenkel  
 Arc en ogive  
 Gothic arch with side extension

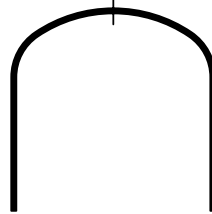



Korbbogen mit Schenkel  
 Anse de panier prolongée  
 Oval arch with side extension

**Bogentüren**  
**Portes cintrées**  
**Arched doors**

**Jansen-Economy 60 Türen**  
**Jansen-Economy 60 portes**  
**Jansen-Economy 60 doors**

Profil Profilé Profile	Min. Radius Rayon min. Min. radius R	
------------------------------	---	--

	blank brut bright	verzinkt zinguée galvanised
	mm	mm
01.634	550	550
01.684	650	650

	blank brut bright	verzinkt zinguée galvanised
	mm	mm
02.634	600	650
02.684	1050	1050

	blank brut bright	verzinkt zinguée galvanised
	mm	mm
04.637	1550	1550

	blank brut bright	verzinkt zinguée galvanised
	mm	mm
05.637	1550	1550

	blank brut bright	verzinkt zinguée galvanised
	mm	mm
400.052	1100	1100
400.054	1000	1000
400.055	800	800
81.010		800

Profil Profilé Profile	Min. Radius Rayon min. Min. radius R	
------------------------------	---	--

	blank brut bright	verzinkt zinguée galvanised
	mm	mm
30.018		550
30.019	650	650

	blank brut bright	verzinkt zinguée galvanised
	mm	mm
30.118	800	800
30.119	900	900

	blank brut bright	verzinkt zinguée galvanised
	mm	mm
30.418	800	800
30.419	1100	1100

Stahl-Glasleisten Parcloses en acier Steel glazing beads	Min. Radius Rayon min. Min. radius R
--	---

	
62.507 Z	300 mm
62.508 Z	300 mm
62.509 Z	300 mm

Stahl-Glasleisten Parcloses en acier Steel glazing beads	Min. Radius Rayon min. Min. radius R
--	---

	
402.112 Z	500 mm
402.115 Z	500 mm
402.120 Z	600 mm
402.125 Z	750 mm
402.130 Z	1000 mm
402.135 Z	1500 mm

Aluminium-Glasleisten Parcloses en aluminium Aluminium glazing beads	Min. Radius Rayon min. Min. radius R
--	---

	
404.109	400 mm
404.112	400 mm
404.115	400 mm
404.120	400 mm
404.125	450 mm
404.130	500 mm
404.135	600 mm

	
405.110	500 mm
405.115	500 mm
405.120	500 mm
405.125	800 mm
405.130	1000 mm
406.903	500 mm
406.905	500 mm
406.907	500 mm
406.909	600 mm

Die Radien-Angaben beziehen sich auf die langjährige Erfahrung und Fertigung im Hause Jansen.

Les rayons indiqués se fondent sur la longue expérience et la fabrication au sein de la maison Jansen.

The radii specifications are based on the many years of experience Jansen has in fabrication.

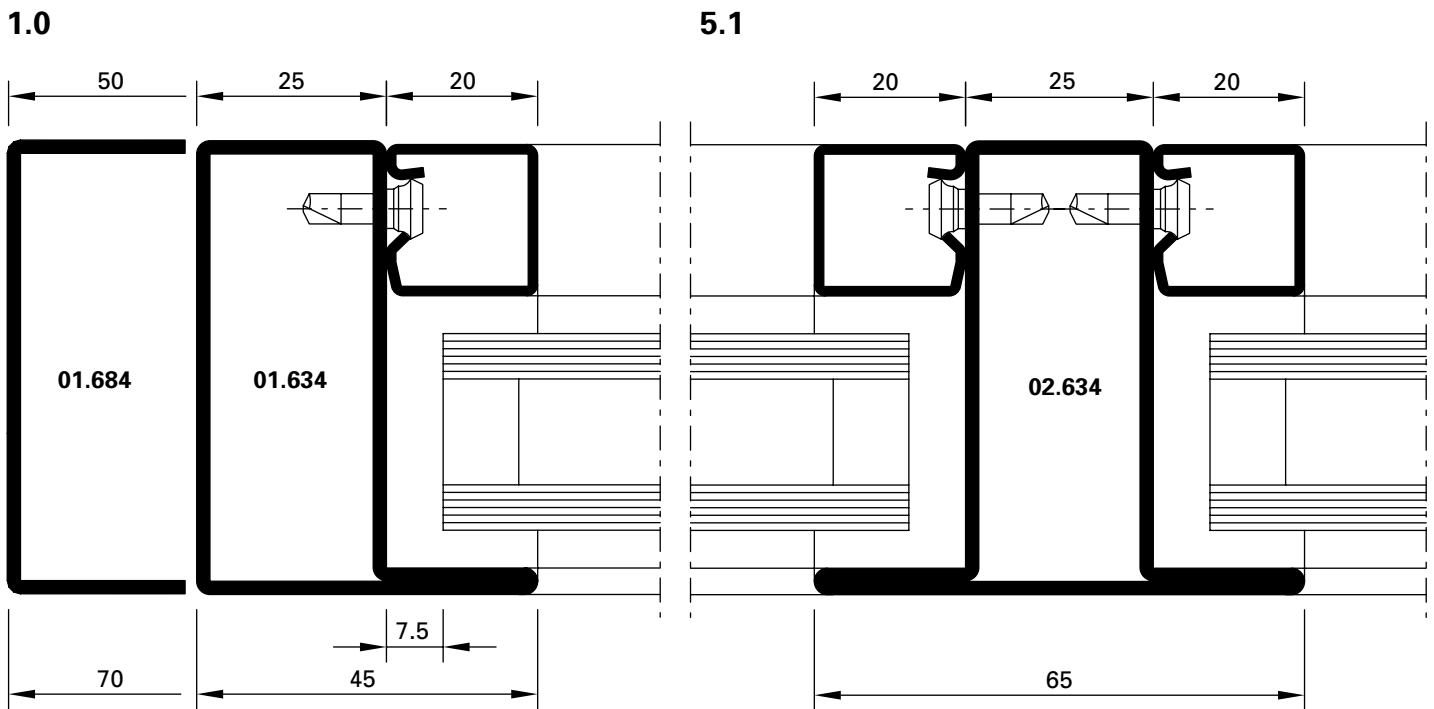
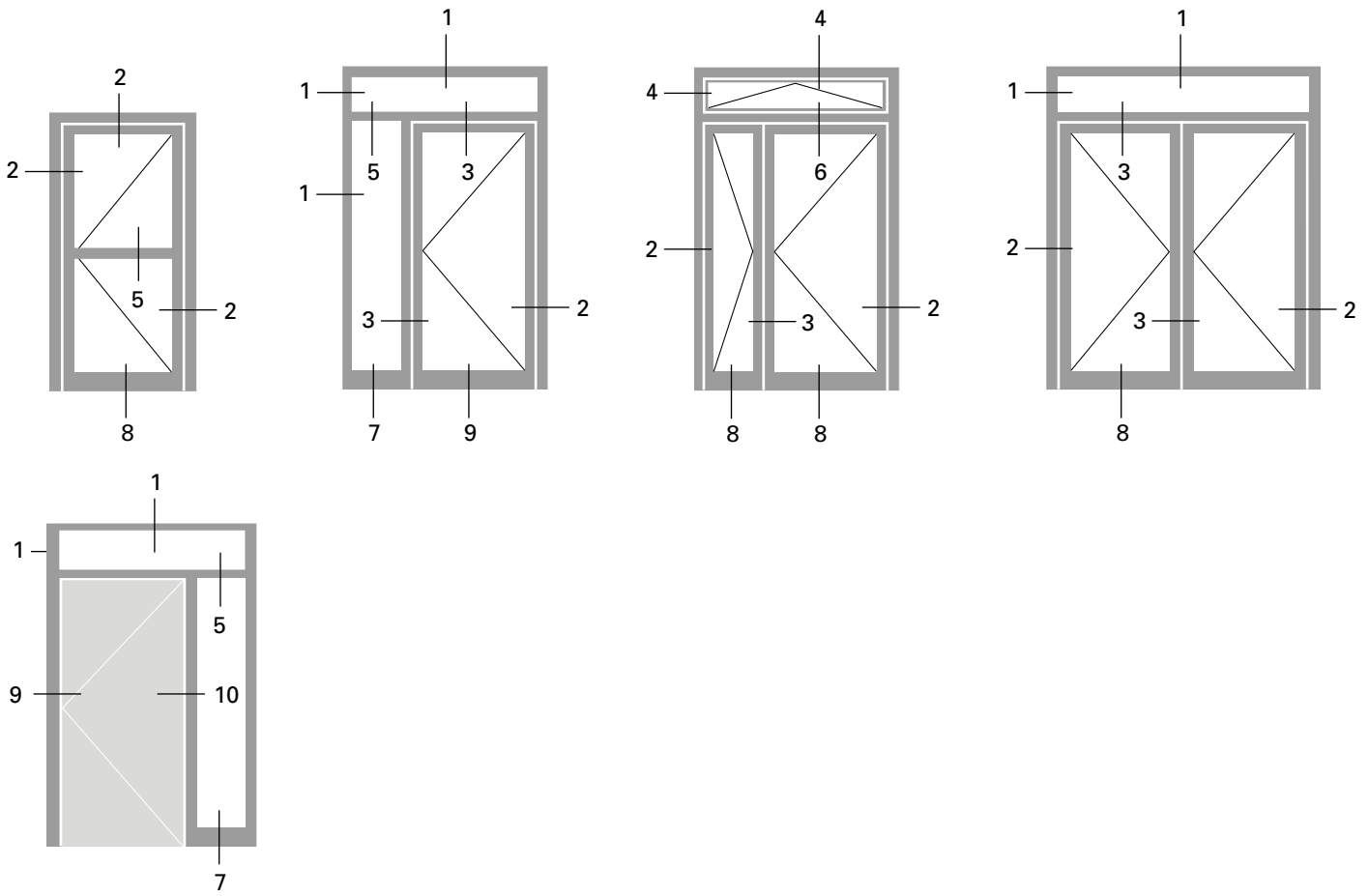

**DXF** **DWG** D-250-C-001

**DXF** **DWG** D-250-C-032

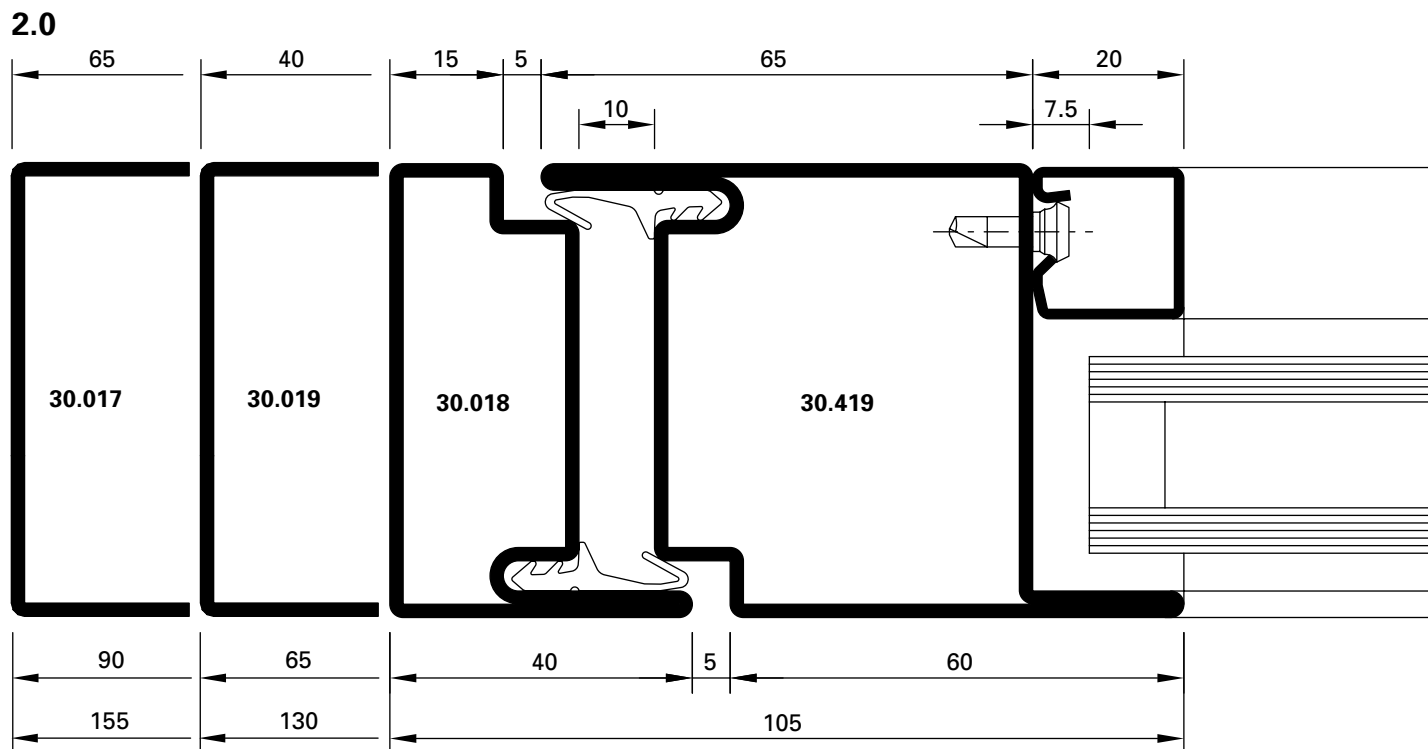

**DXF** **DWG** D-250-C-002

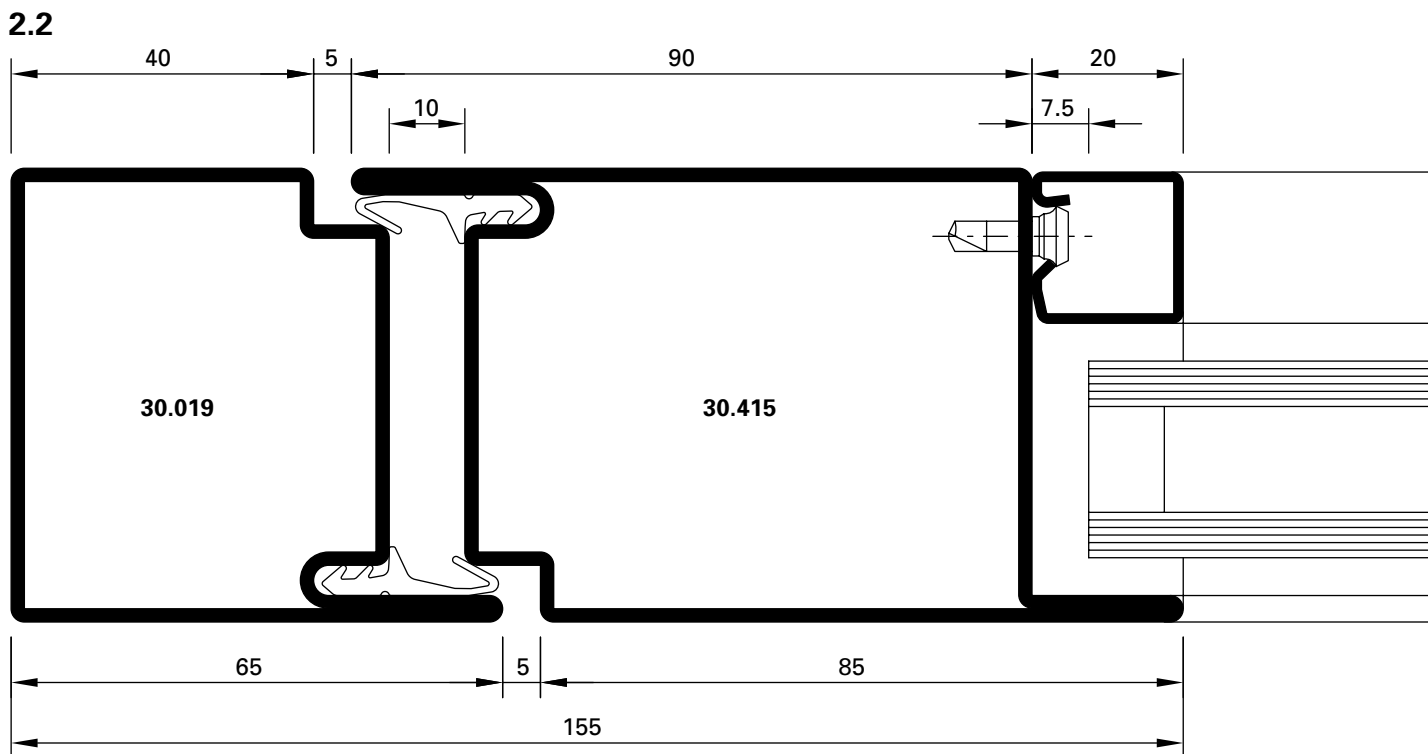

**DXF** **DWG** D-250-C-005

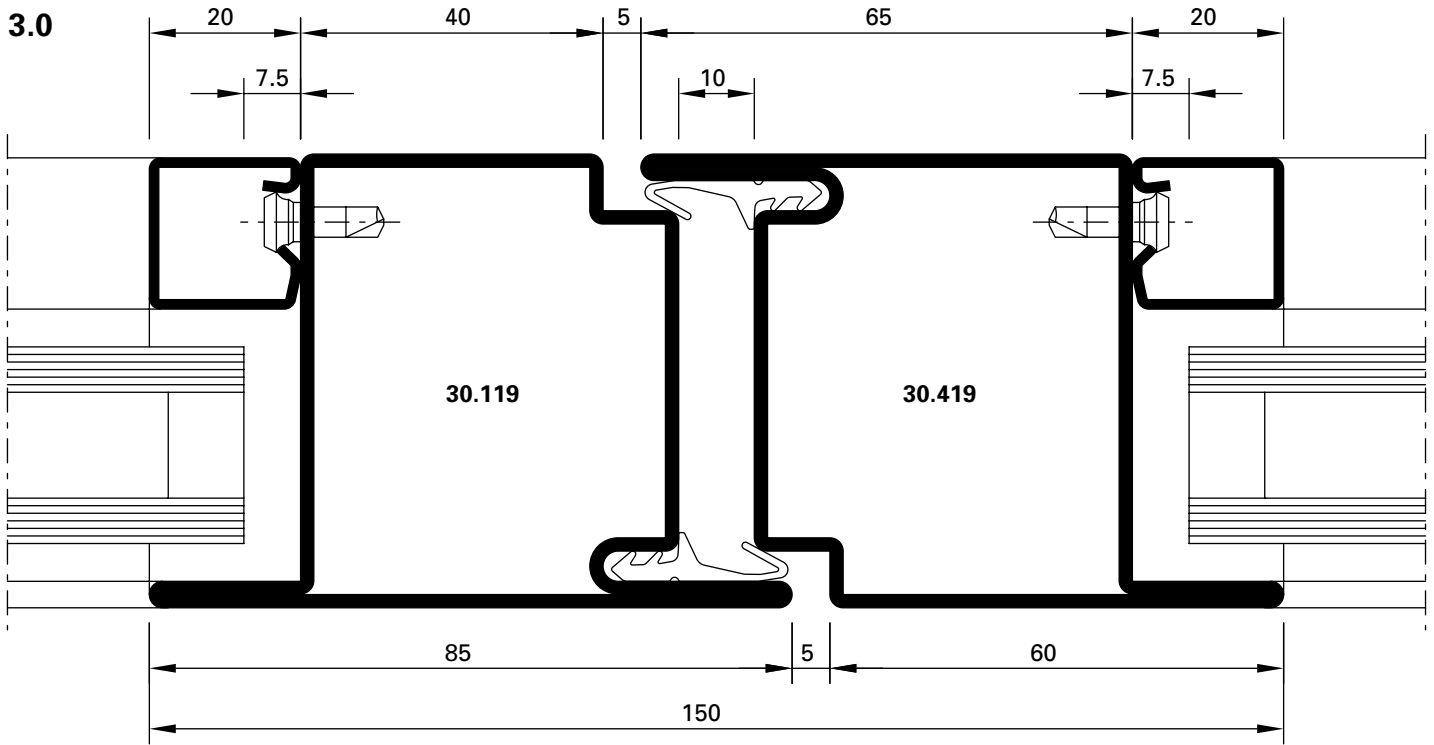

DXF DWG D-250-C-003

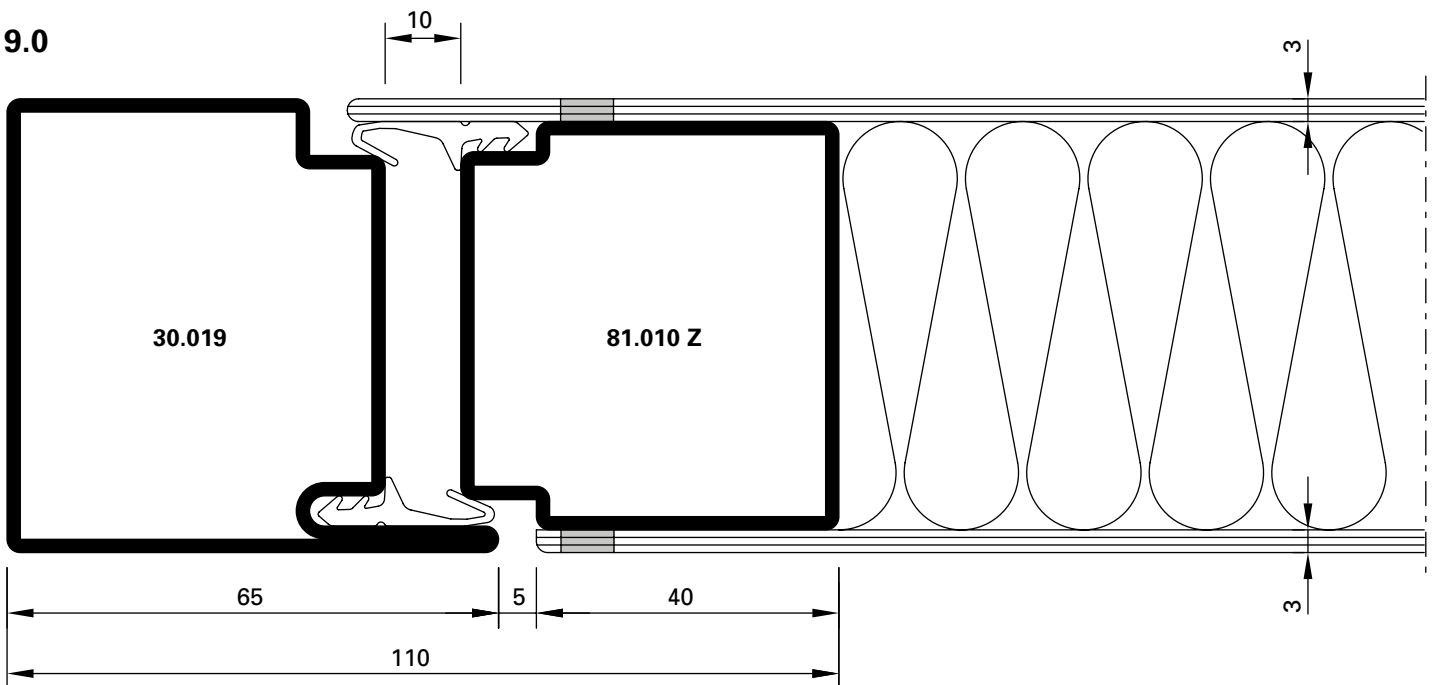

DXF DWG D-250-C-013

4.0

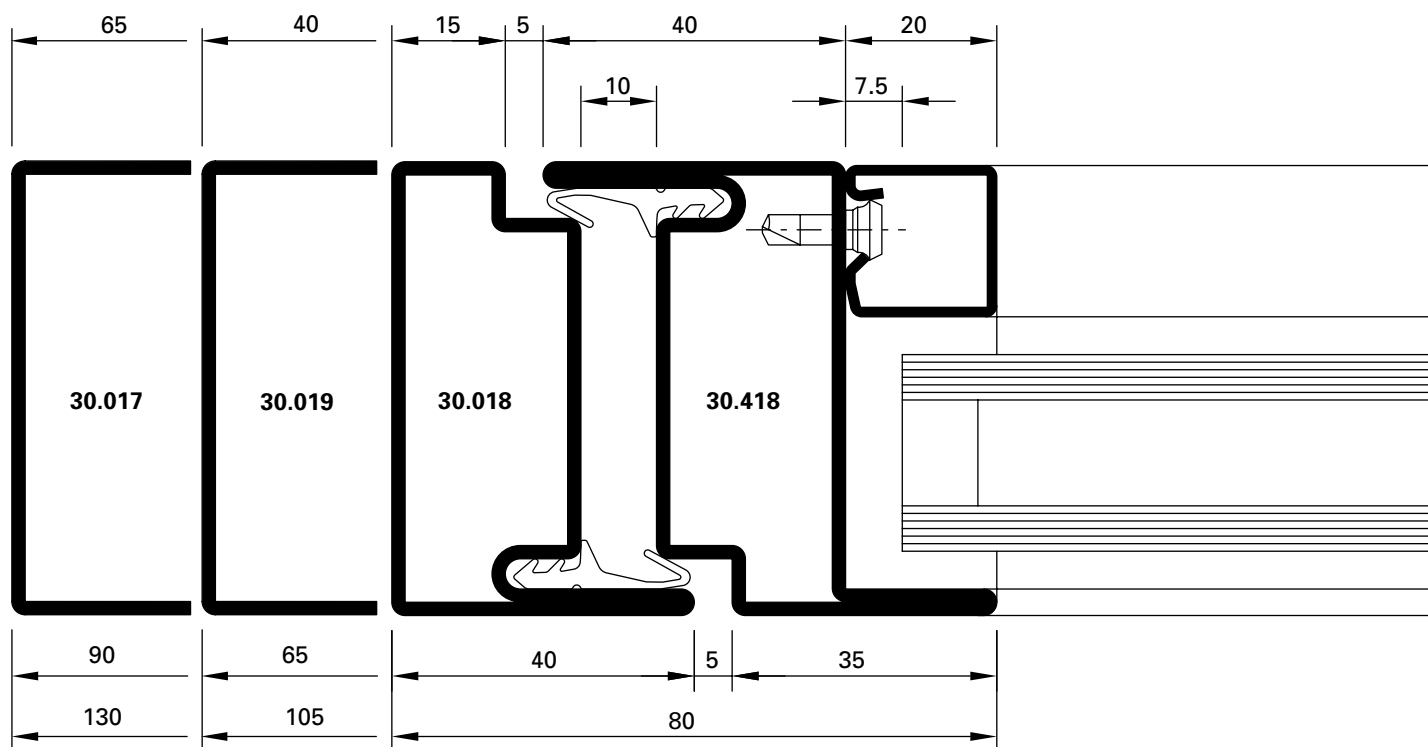

**DXF** **DWG** D-250-C-010

5.0

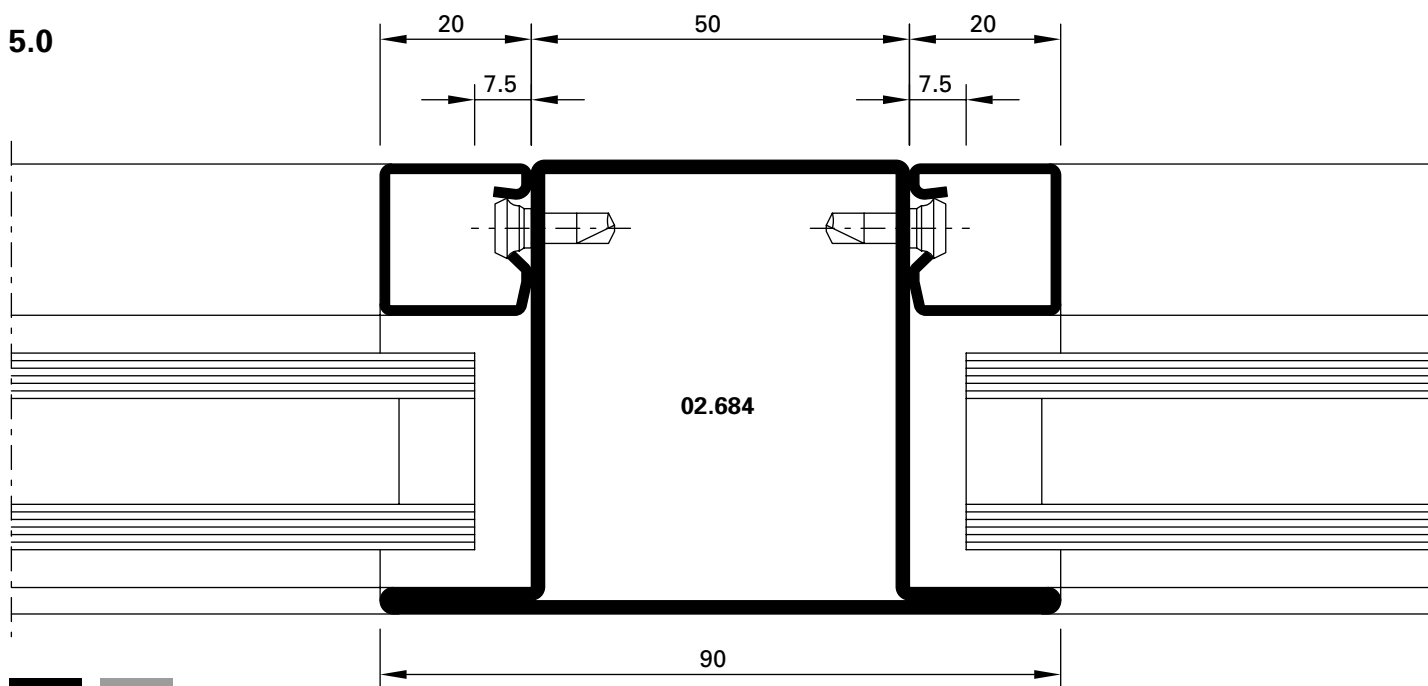

**DXF** **DWG** D-250-C-012

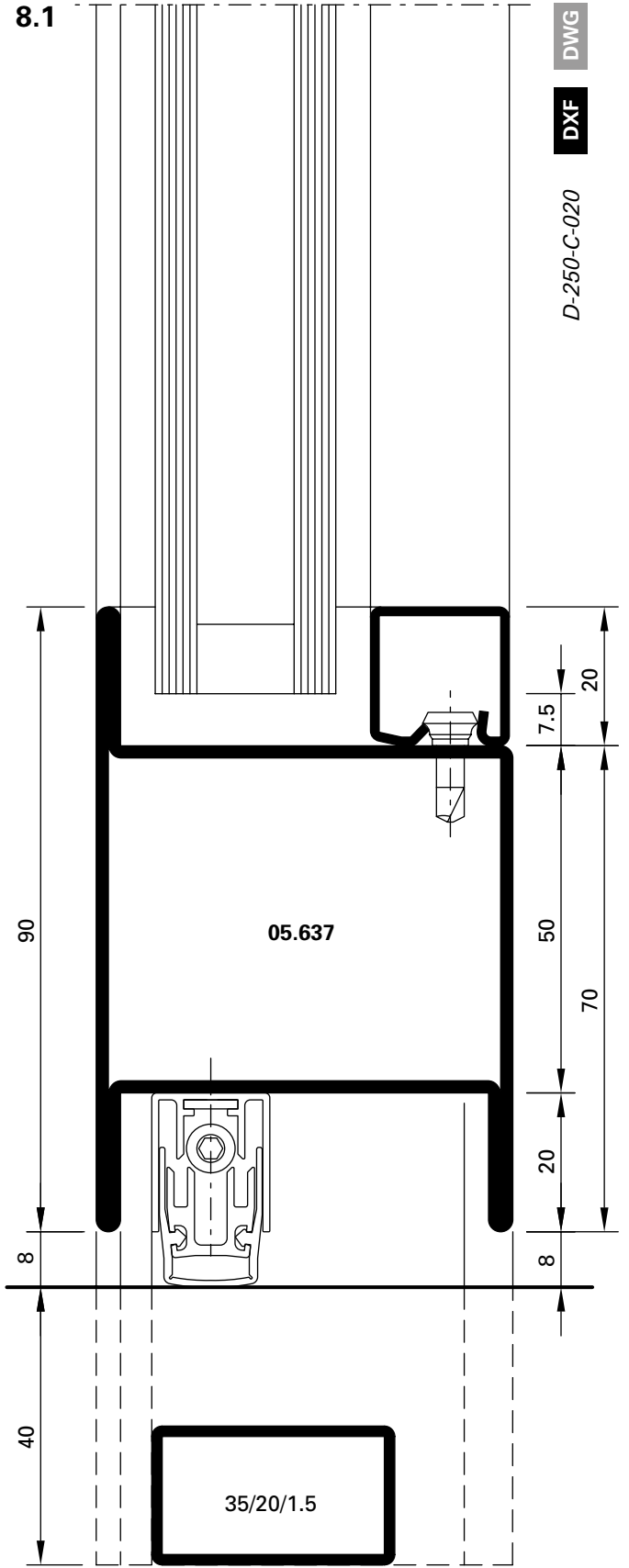
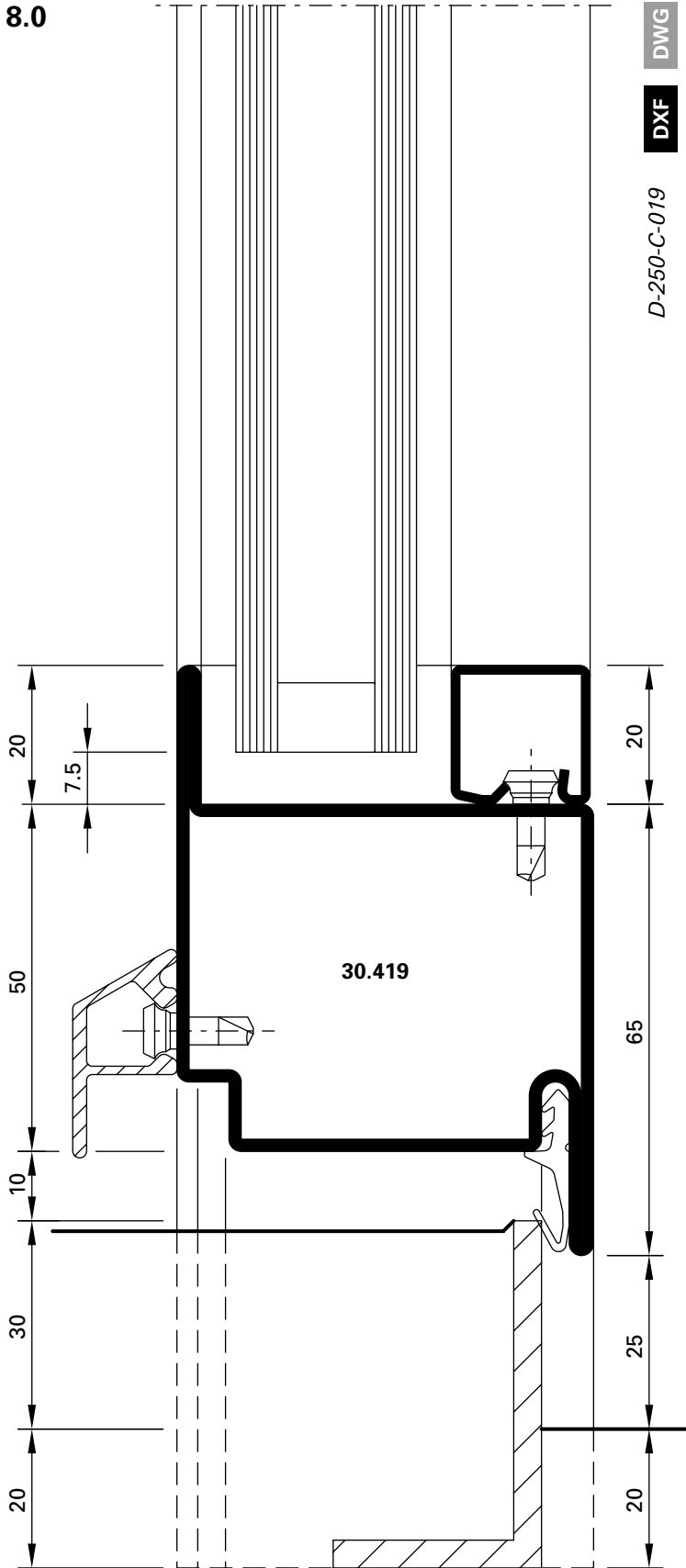



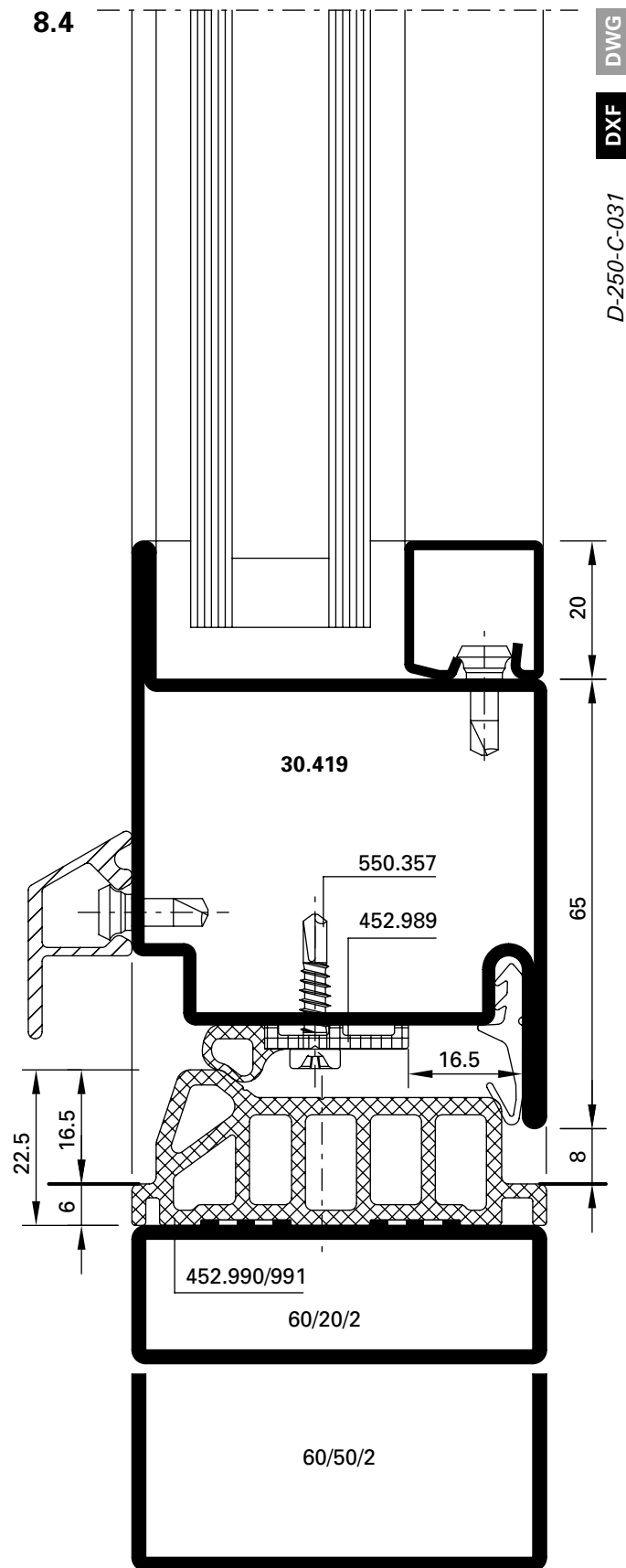
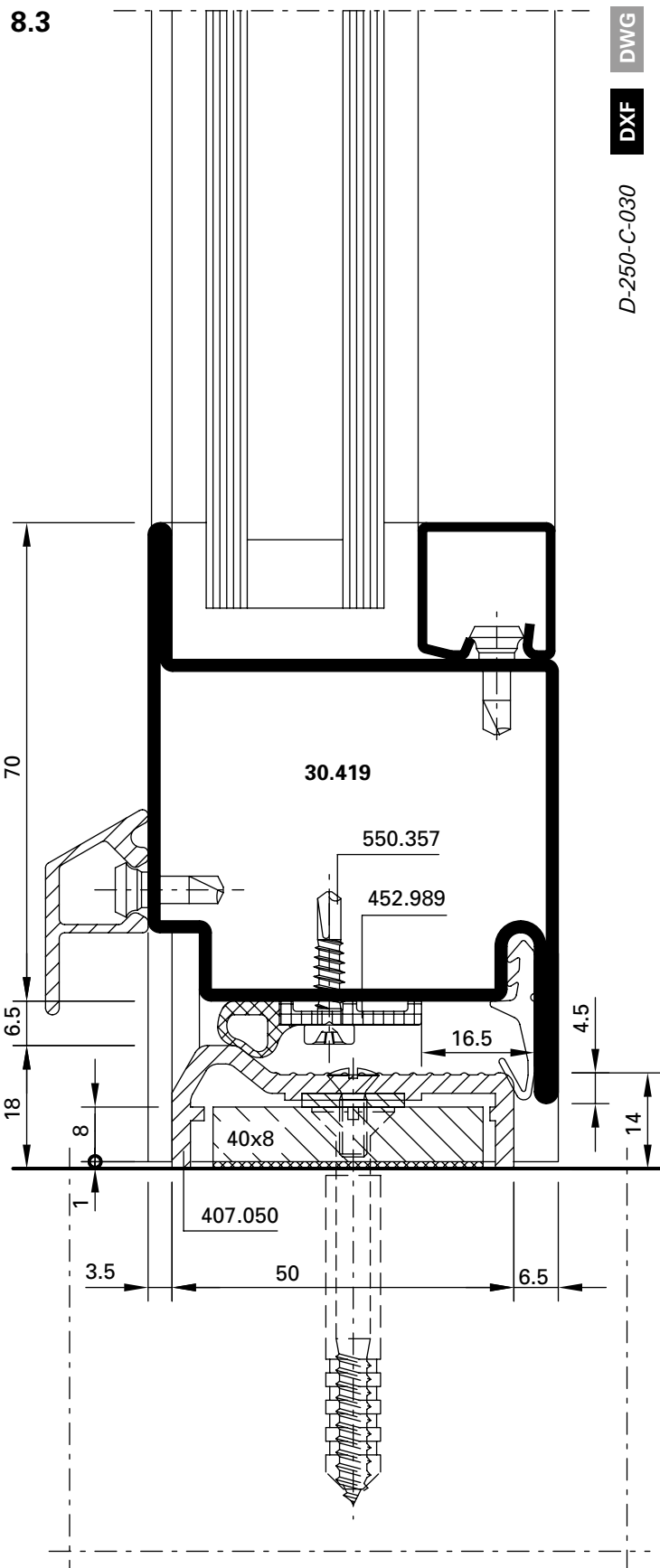

2.1

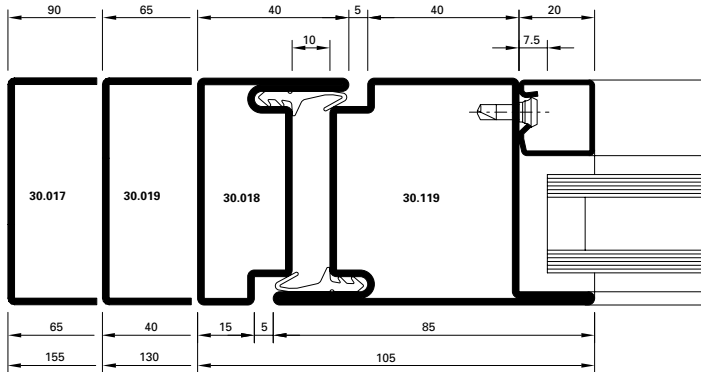

**DXF** **DWG** *D-250-C-004*

2.3

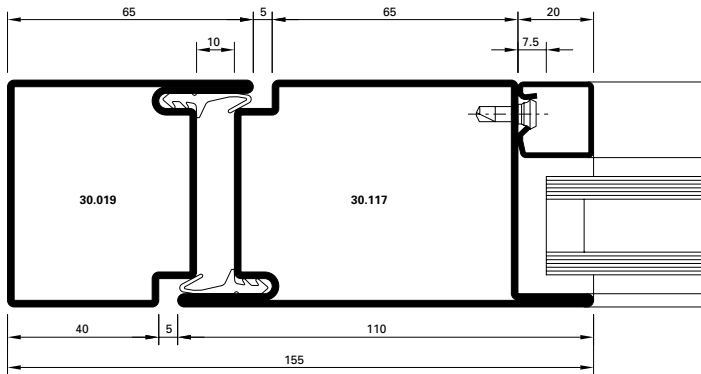

**DXF** **DWG** *D-250-C-006*

3.1

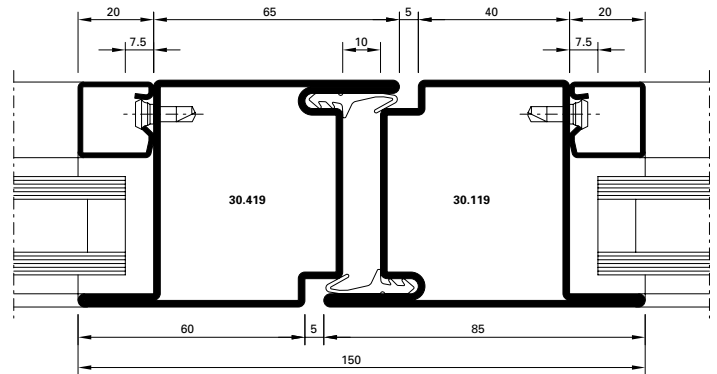

**DXF** **DWG** *D-250-C-007*

3.2

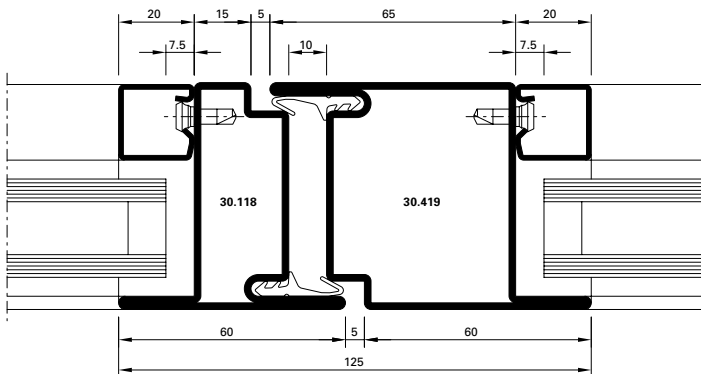

**DXF** **DWG** *D-250-C-008*

3.3

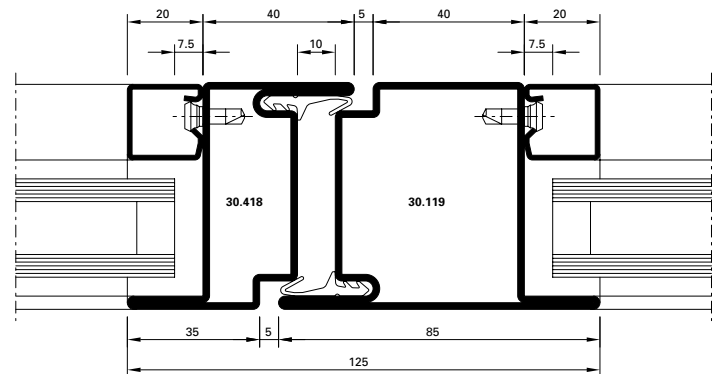

**DXF** **DWG** *D-250-C-009*

9.1

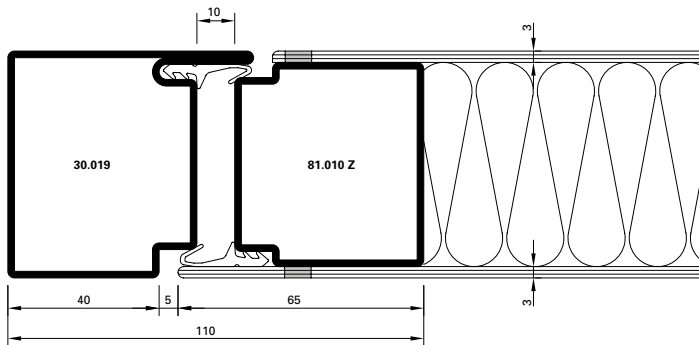

**DXF** **DWG** D-250-C-014

10.0

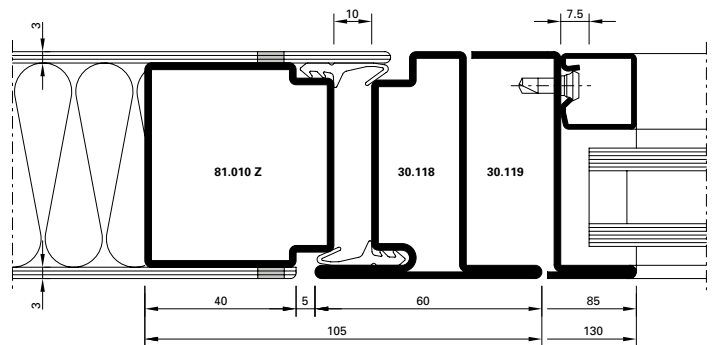

**DXF** **DWG** D-250-C-015

6.0

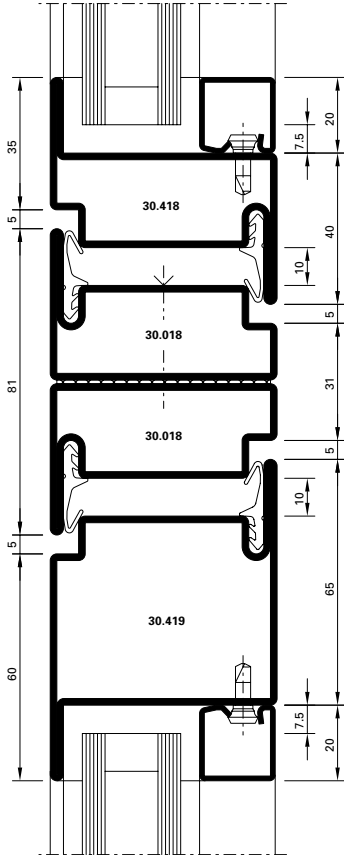

DWG

DXF

D-250-C-016

7.0

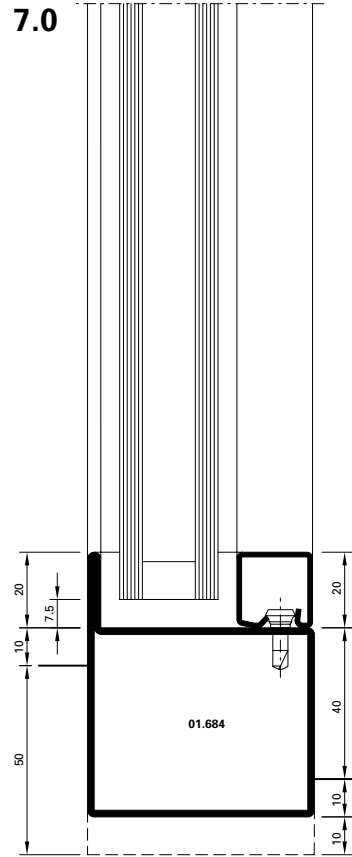

DWG

DXF

D-250-C-017

8.2

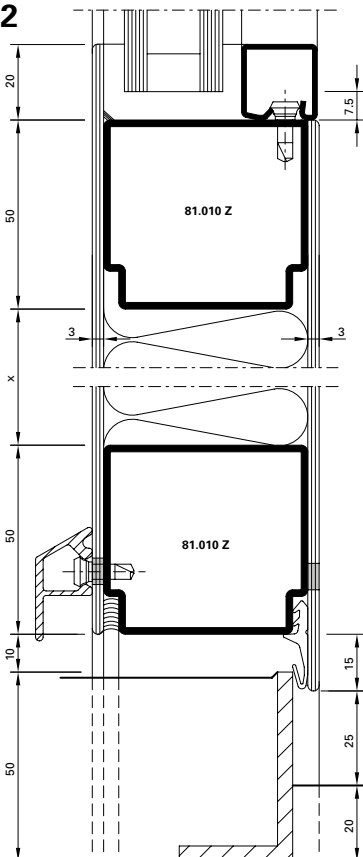

DWG

DXF

D-250-C-021

5.1

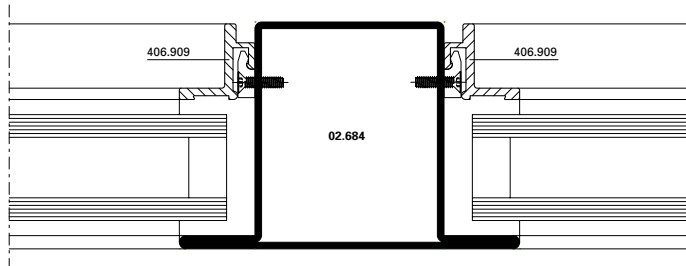

**DXF** **DWG** *D-250-C-022*

5.2

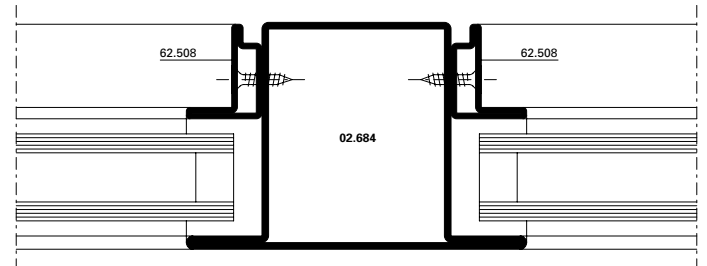

**DXF** **DWG** *D-250-C-023*

5.3

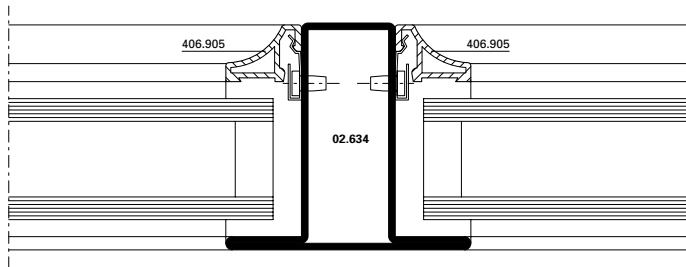

**DXF** **DWG** *D-250-C-024*

5.4

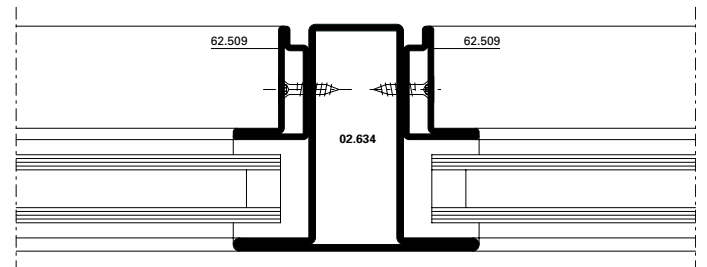

**DXF** **DWG** *D-250-C-025*

5.5

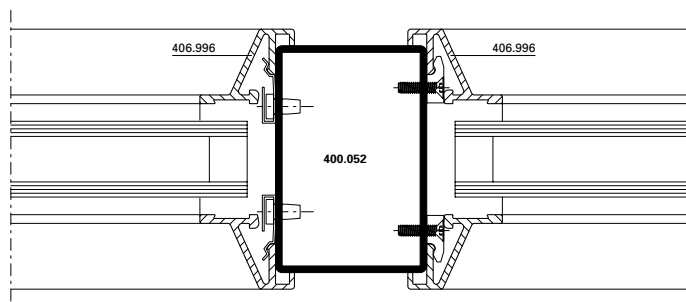

**DXF** **DWG** *D-250-C-026*

5.6

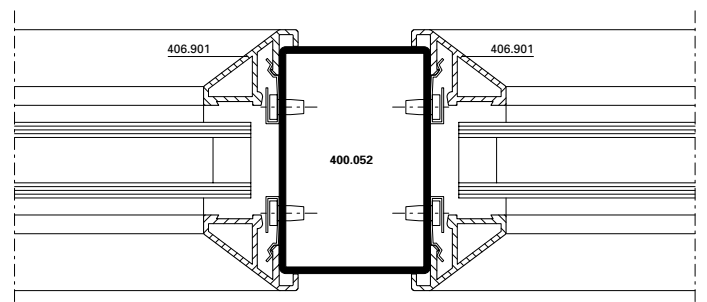

**DXF** **DWG** *D-250-C-027*

5.7

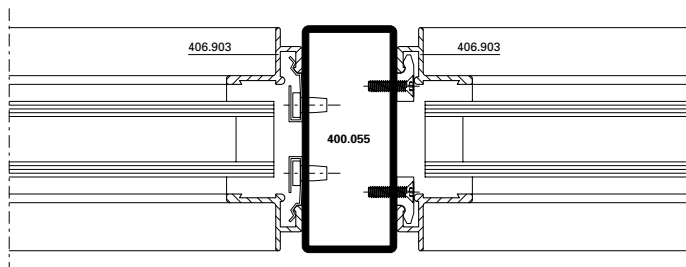

**DXF** **DWG** *D-250-C-028*

5.8

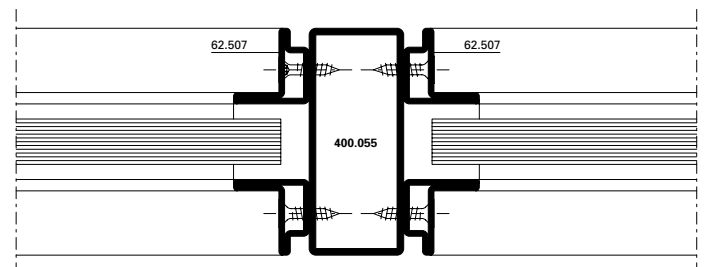

**DXF** **DWG** *D-250-C-029*

**Schnittpunkte im Massstab 1:1**  
**Coupe de détails à l'échelle 1:1**  
**Section details on scale 1:1**

**Jansen-Economy 60 Türen**  
**Jansen-Economy 60 portes**  
**Jansen-Economy 60 doors**

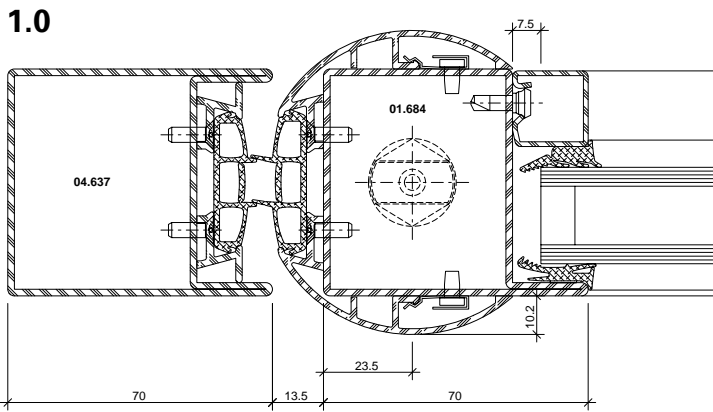
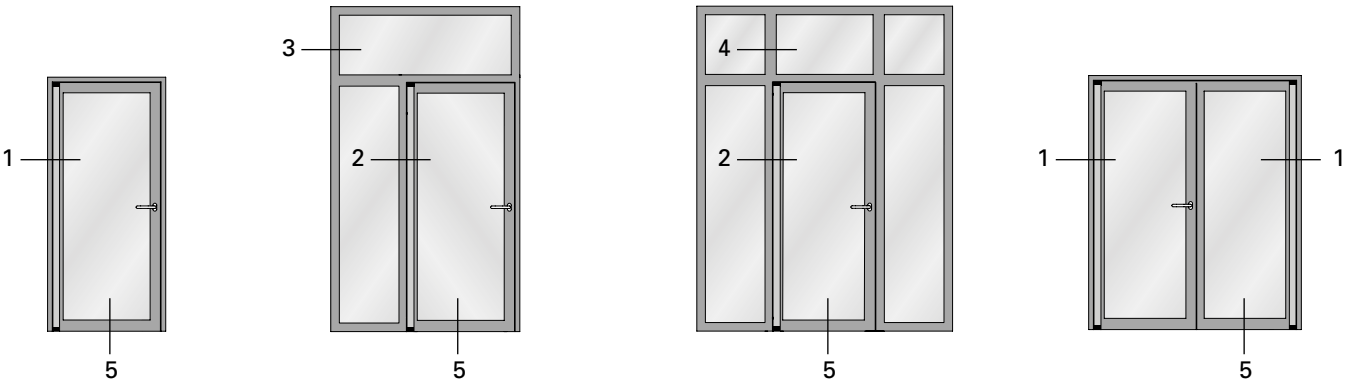

**DXF** **DWG** 22-0103-C-001

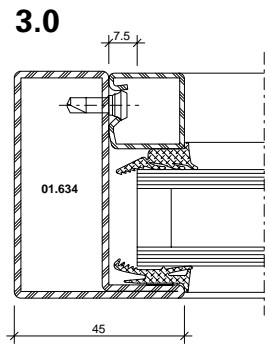

22-0101-C-001

**DXF** **DWG**

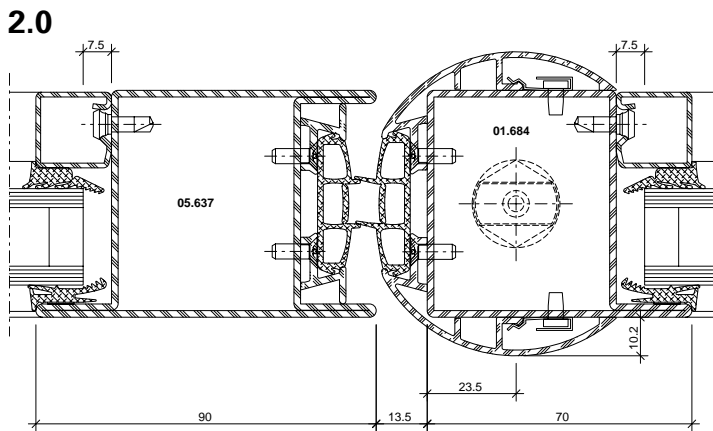

**DXF** **DWG** 22-0103-C-002

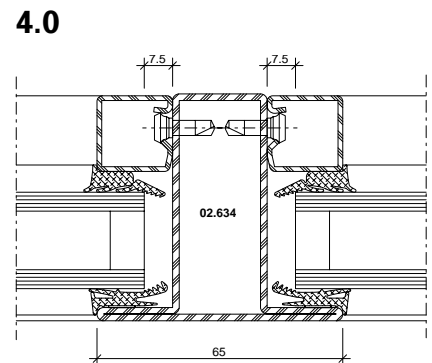

22-0101-C-002

**DXF** **DWG**

5.0

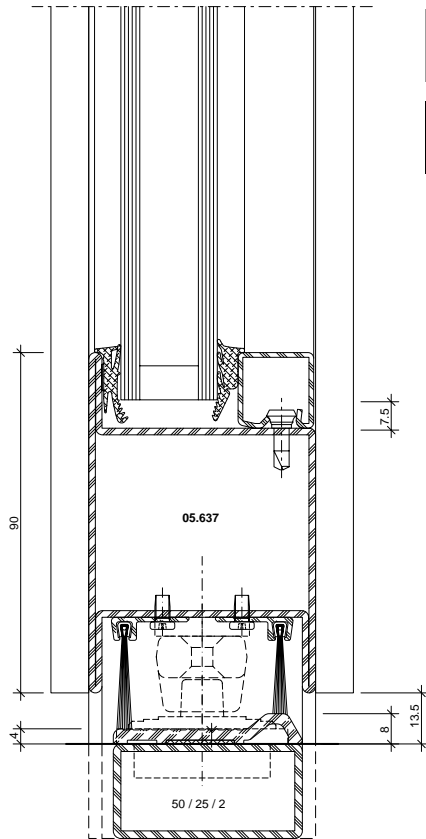

DWG

DXF

22-0103-C-003

5.1

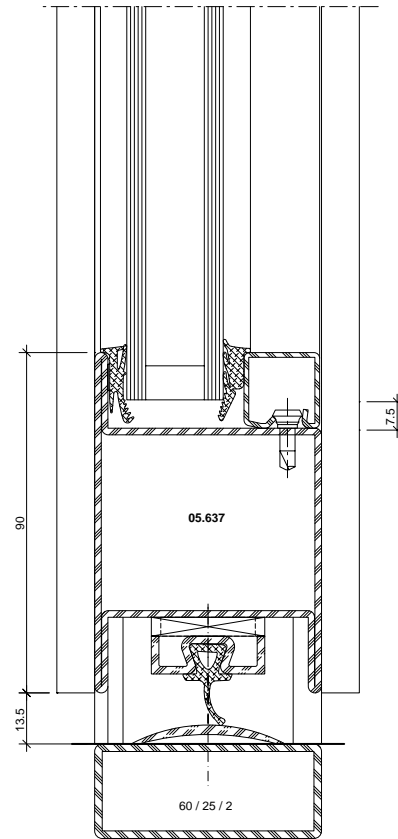

DWG

DXF

22-0103-C-009

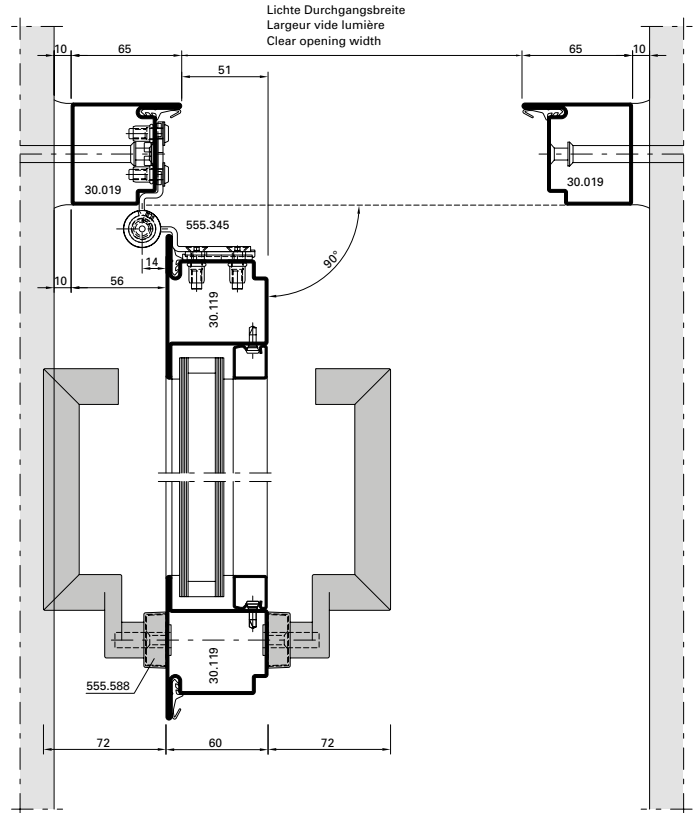
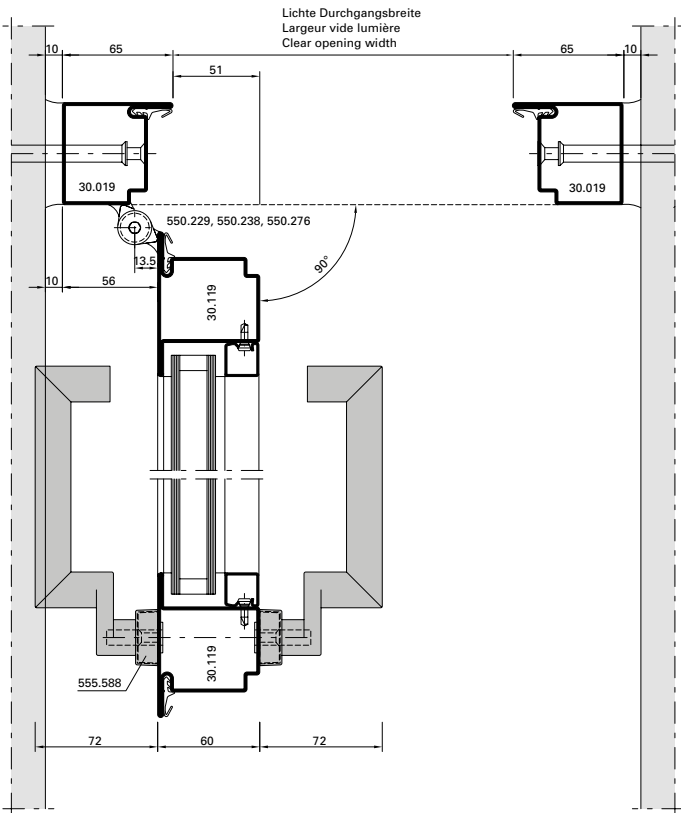

**DXF** **DWG** *D-250-E-016*

**DXF** **DWG** *D-250-E-018*

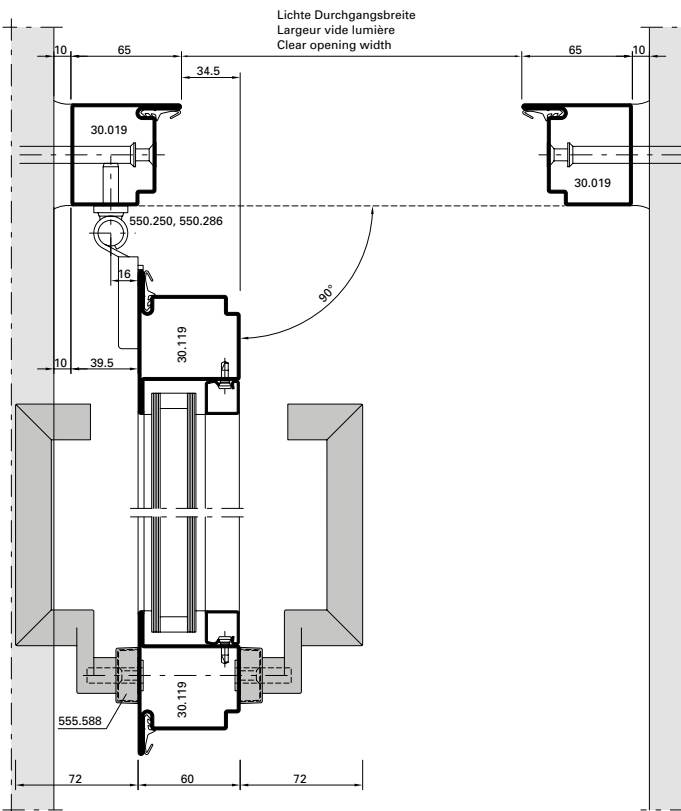

**DXF** **DWG** *D-250-E-020*



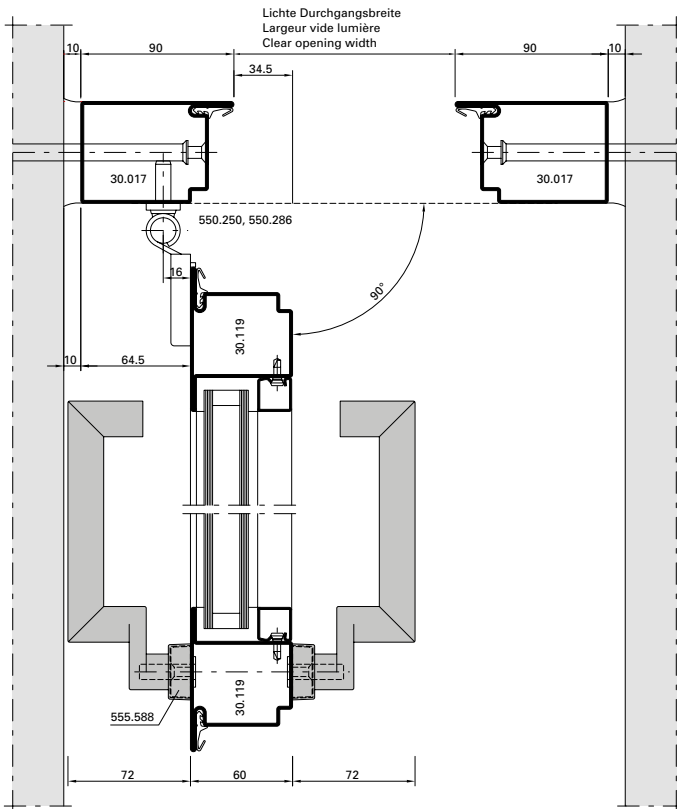

**DXF** **DWG** *D-250-E-021*

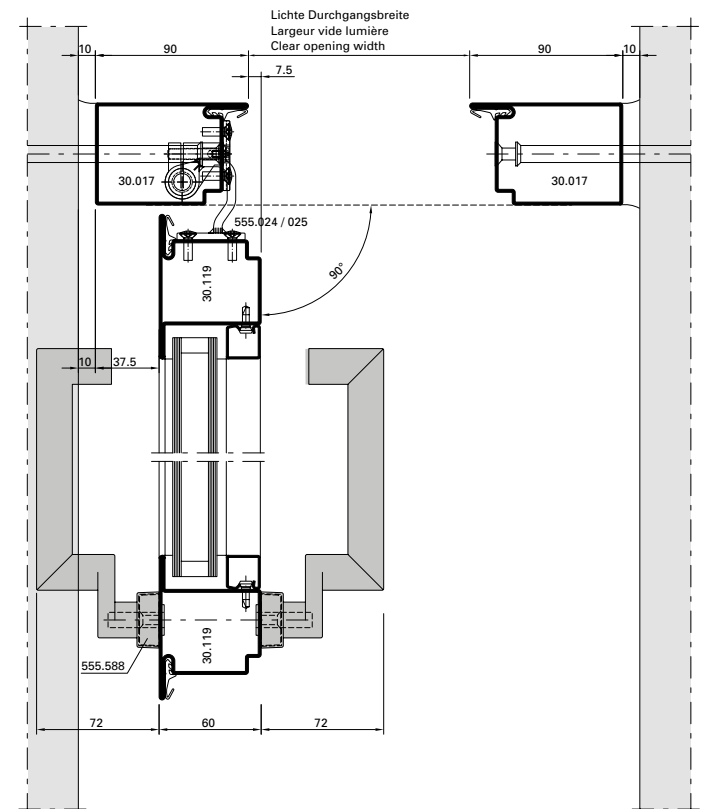

**DXF** **DWG** *D-250-E-025*

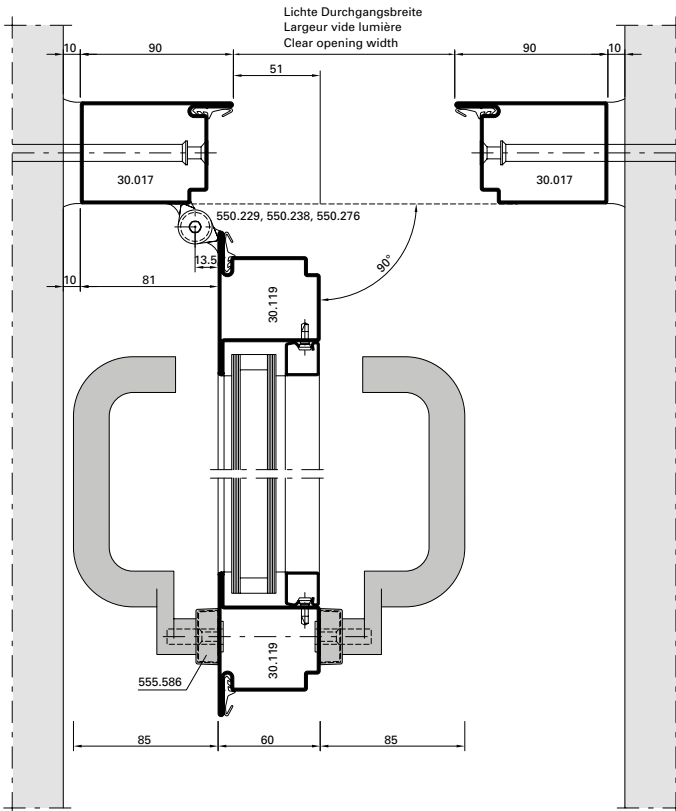

**DXF** **DWG** *D-250-E-017*

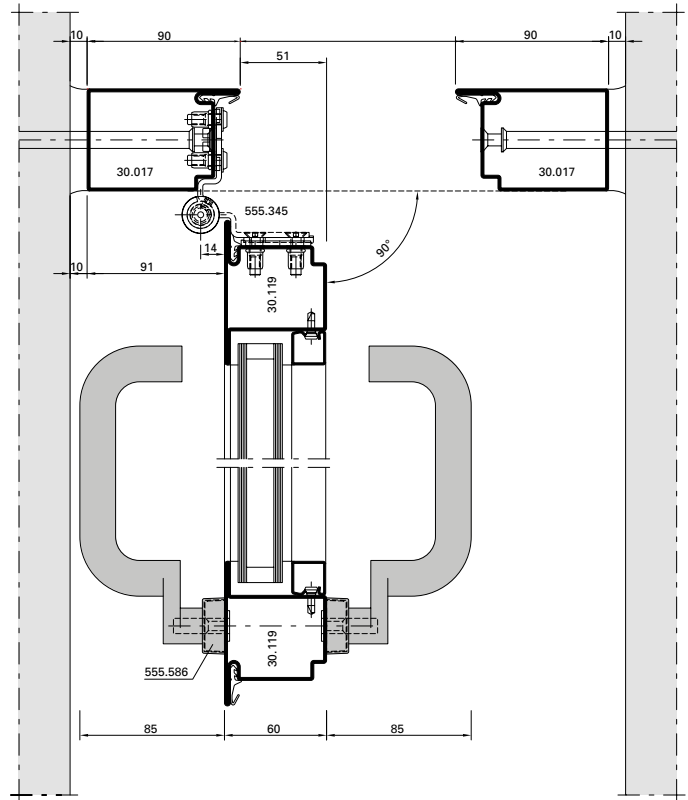

**DXF** **DWG** *D-250-E-019*

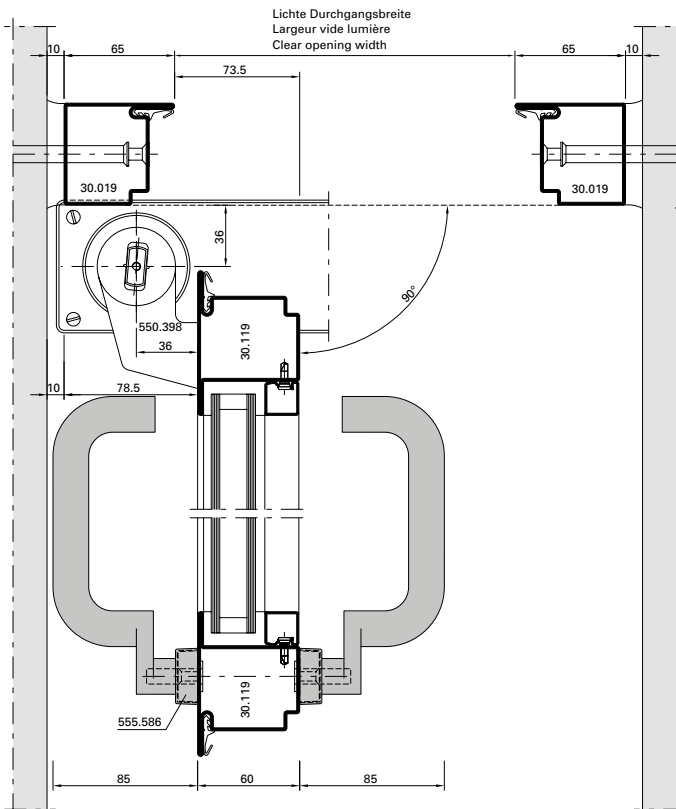

**DXF** **DWG** *D-250-E-022*

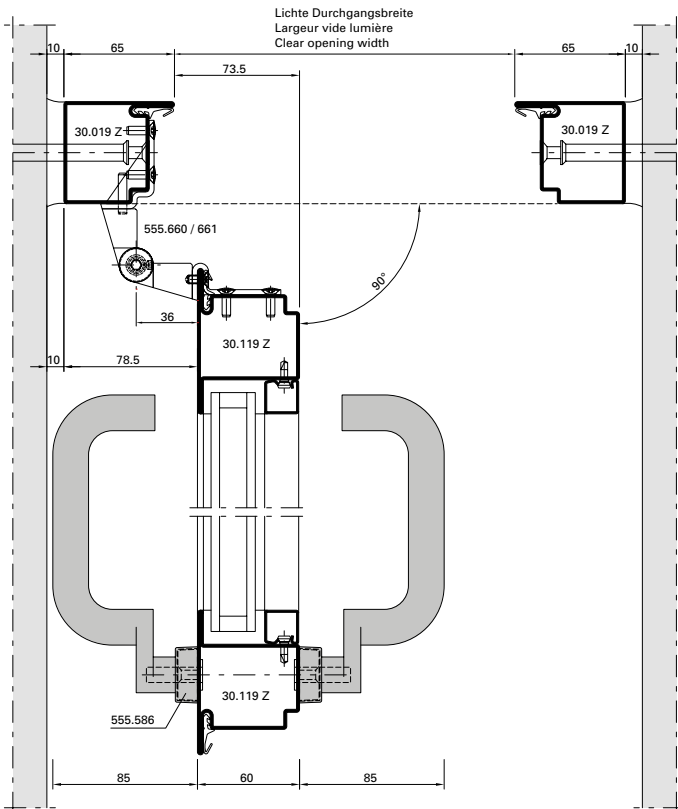

**DXF** **DWG** *D-250-E-023*

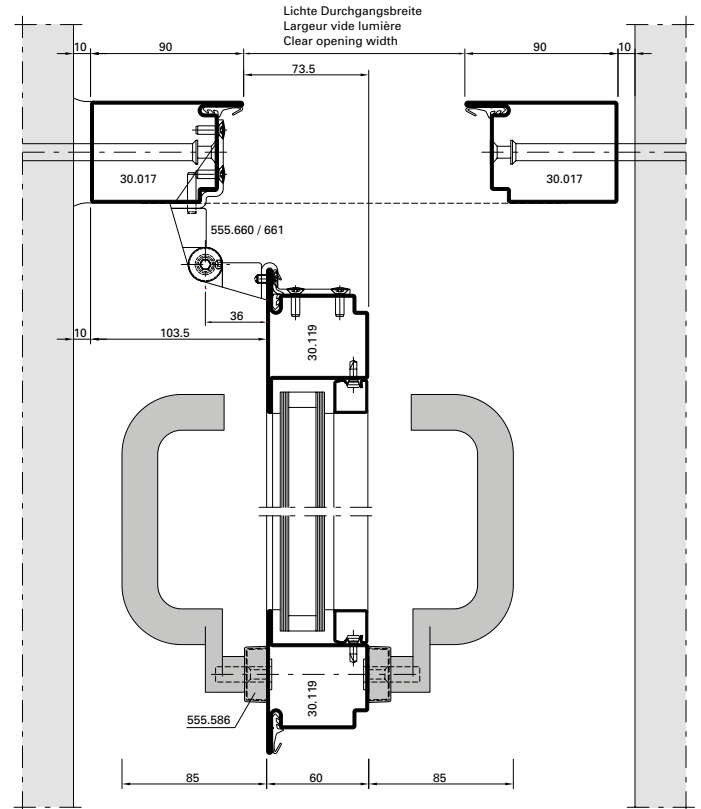

**DXF** **DWG** *D-250-E-024*

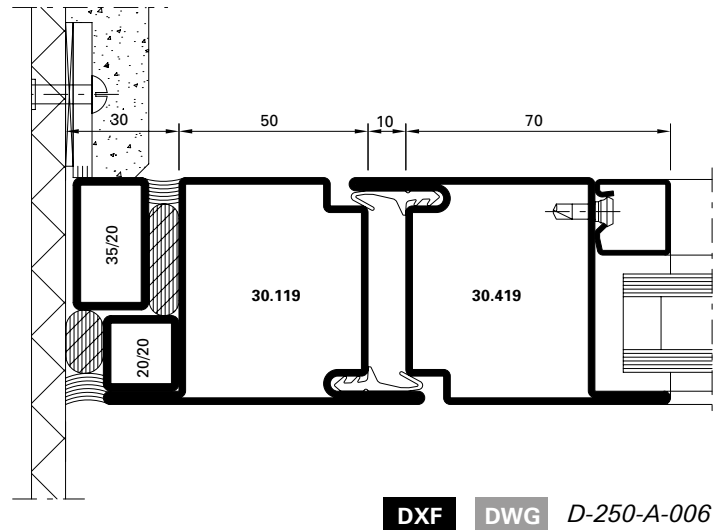
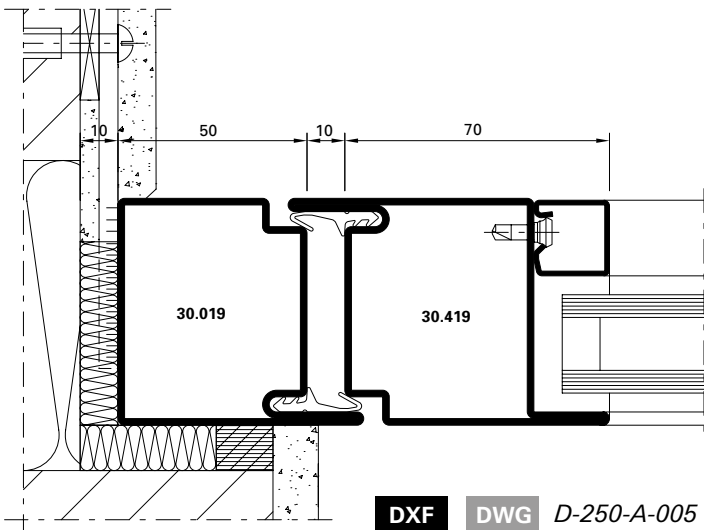
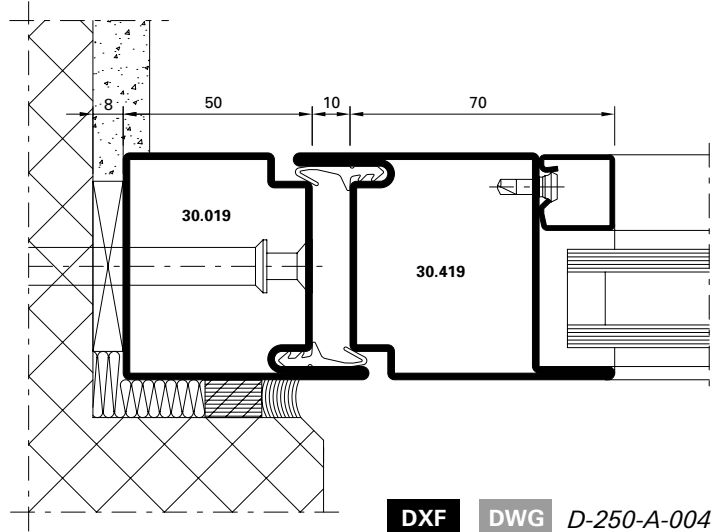
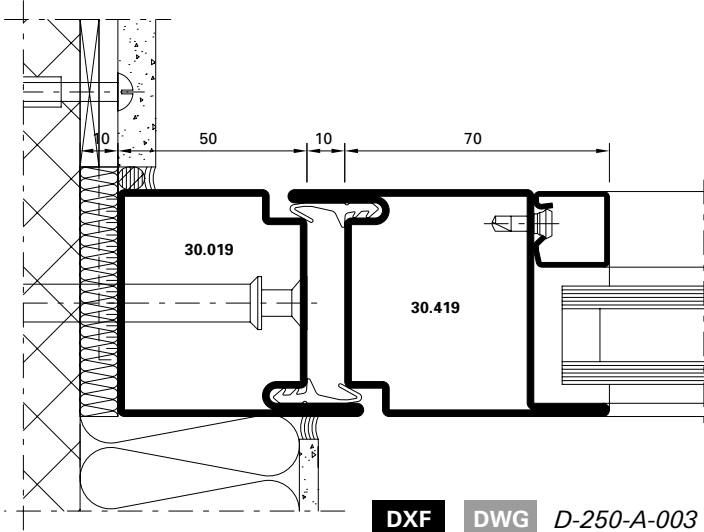
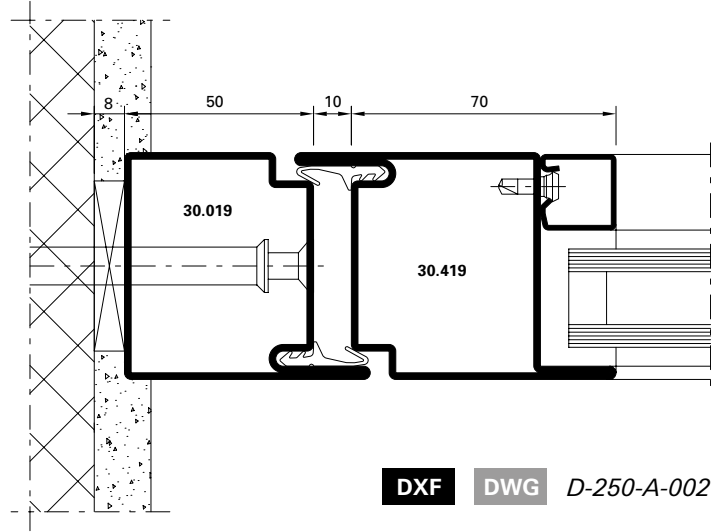
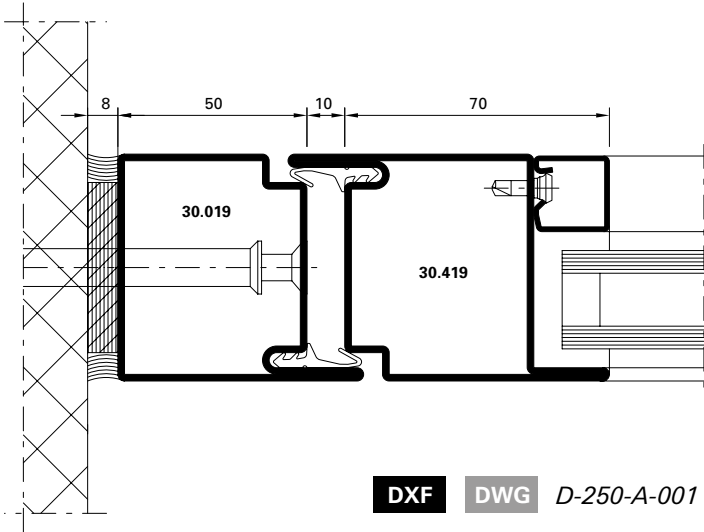

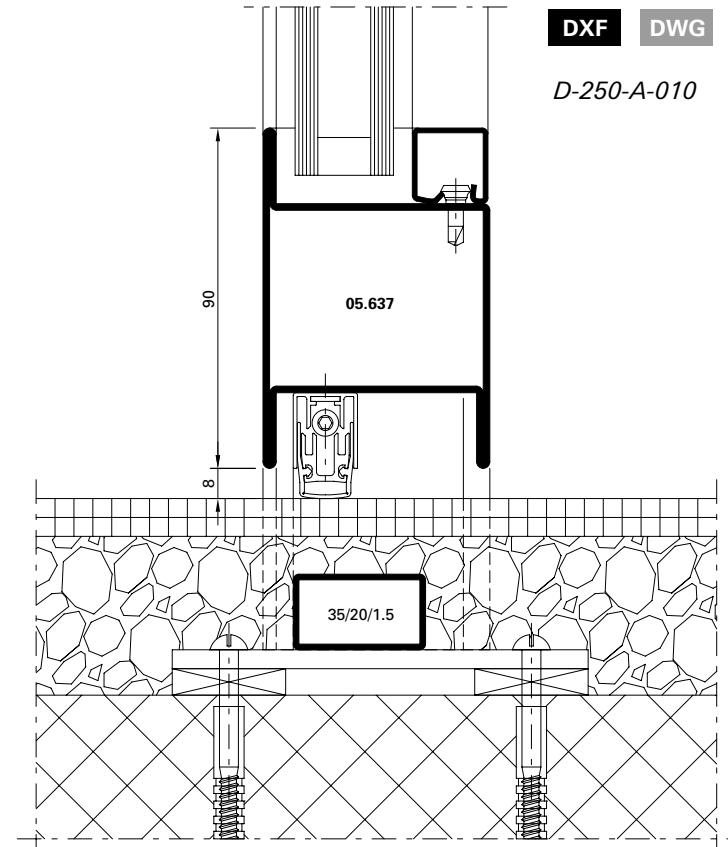
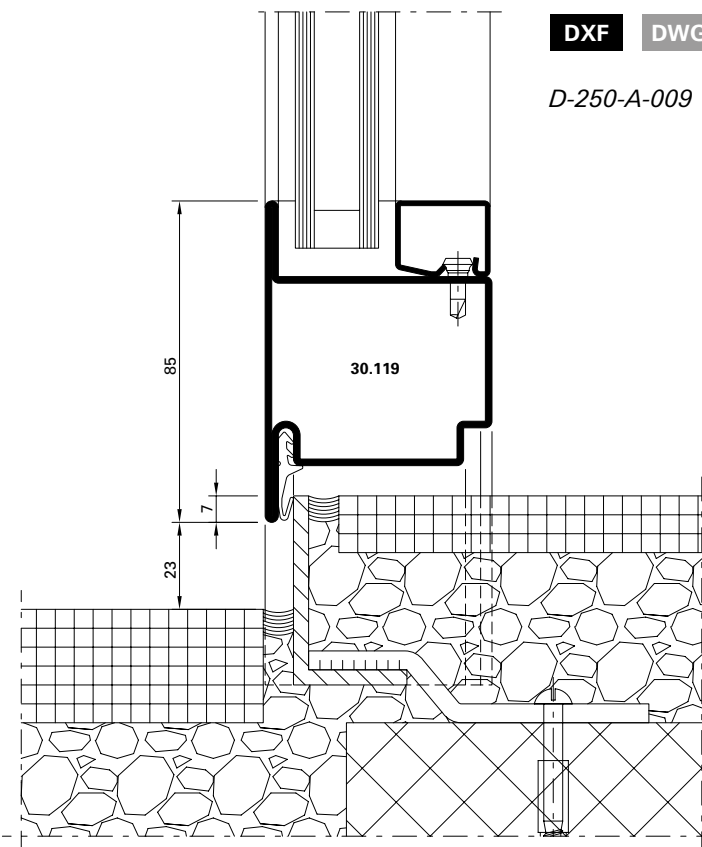
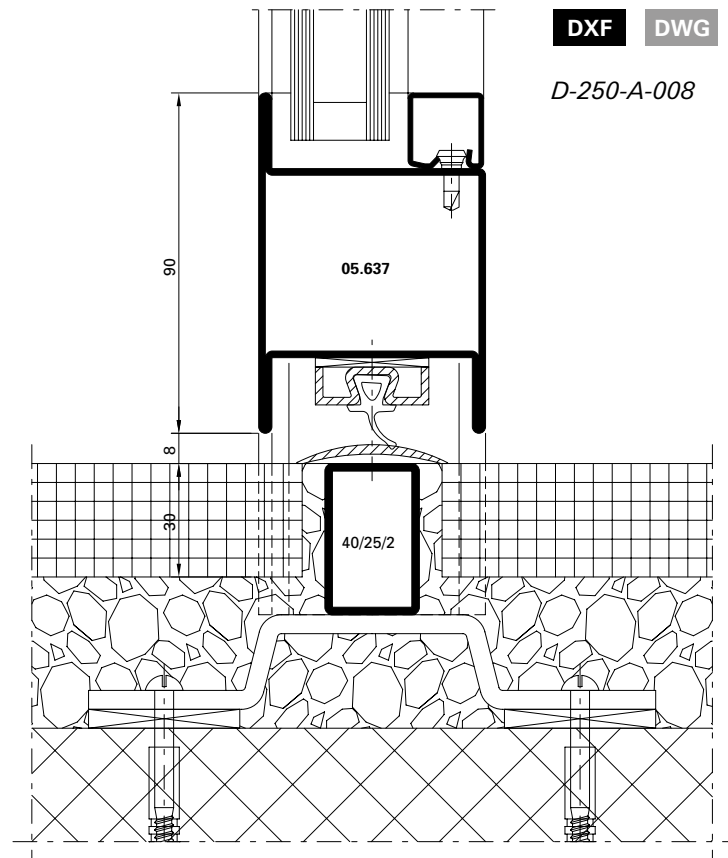
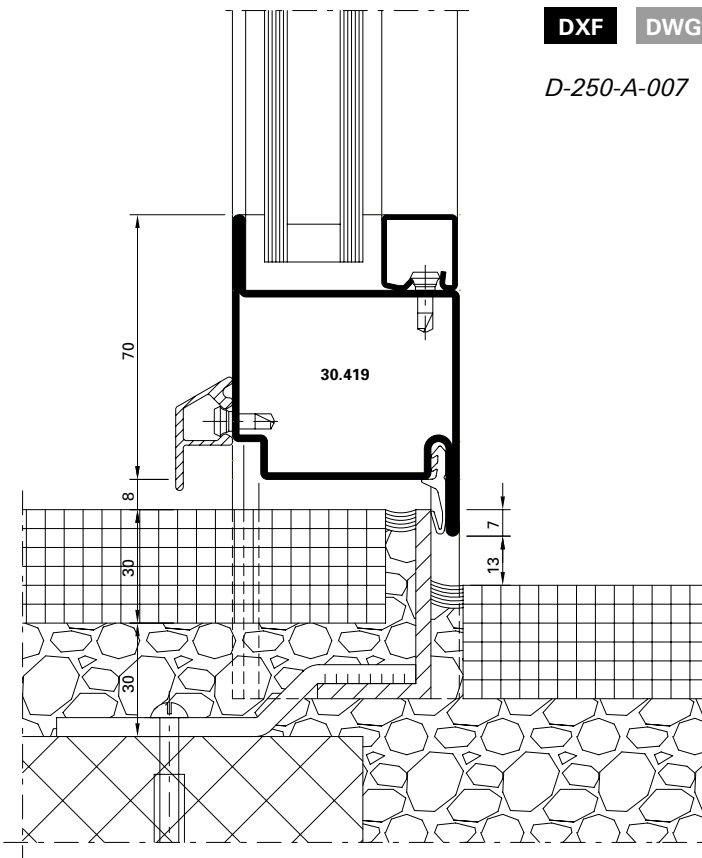



Einflügelige Türen,  
 auswärts öffnend,  
 Flügelhöhe ≤ 2200 mm

Porte à un vantail,  
 ouvrant vers l'extérieur,  
 hauteur du vantail ≤ 2200 mm

Single leaf door,  
 outward opening,  
 leaf height ≤ 2200 mm

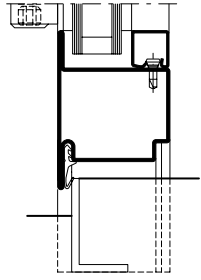
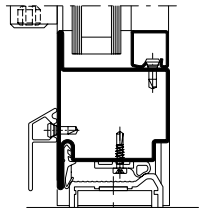
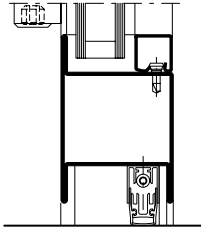
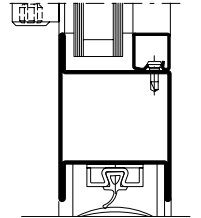
Variante	Beschlag Ferrure Fitting	 EN 12207	 EN 12208	 EN 12210
Anschlagdichtung Joint de butée Rebate gasket 	1	2	1A	C4
	2	2	2A	C4
	3	3	2A	C5
Doppel-Anschlagdichtung Joint de base double Double rebate gasket 	1	4	3A	C4
	2	4	3A	C4
	3	4	5A	C5
Senkdichtung Joint seuil Drop seal 	1	2	1A	C4
	2	2	2A	C4
	3	3	2A	C5
Auflaufdichtung Joint de contact Ramp seal 	1	2	0	C4
	2	2	0	C4
	3	2	0	C5

1 Fallenriegel-Schloss  
 Serrure à mortaiser  
 Latch and bolt lock





2 Schloss mit Obenverriegelung  
 Serrure avec verrouillage supérieur  
 Lock with top locking point

3 Mehrfachverriegelungs-Schloss  
 Serrure à verrouillage multiple  
 Multipoint lock

Einflügelige Türen,  
 einwärts öffnend,  
 Flügelhöhe ≤ 2200 mm

Porte à un vantail,  
 ouvrant vers l'intérieur,  
 hauteur du vantail ≤ 2200 mm

Single leaf door,  
 inward opening,  
 leaf height ≤ 2200 mm

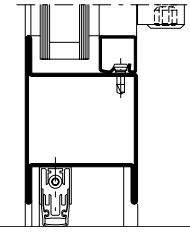
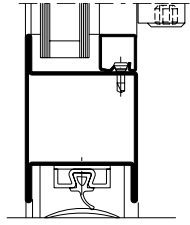
Variante		Beschlag Ferrure Fitting	 EN 12207	 EN 12208	 EN 12210
Senkdichtung Joint seuil Drop seal		❶	2	0	C4
		❷	2	0	C4
		❸	3	1A	C5
Auflaufdichtung Joint de contact Ramp seal		❶	2	0	C4
		❷	2	0	C4
		❸	2	0	C5

❶ Fallenriegel-Schloss  
 Serrure à mortaiser  
 Latch and bolt lock



❷ Schloss mit Obenverriegelung  
 Serrure avec verrouillage supérieur  
 Lock with top locking point

❸ Mehrfachverriegelungs-Schloss  
 Serrure à verrouillage multiple  
 Multipoint lock

Einflügelige Türen,  
 auswärts öffnend,  
 Flügelhöhe ≤ 3000 mm

Porte à un vantail,  
 ouvrant vers l'extérieur,  
 hauteur du vantail ≤ 3000 mm

Single leaf door,  
 outward opening,  
 leaf height ≤ 3000 mm

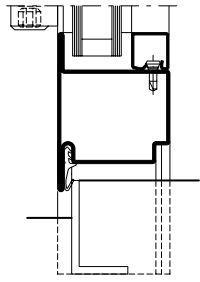
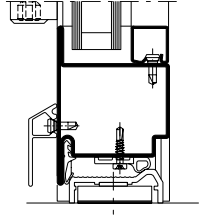
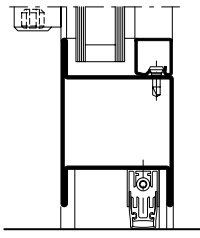
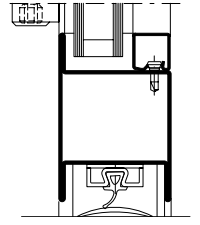
Variante	Beschlag Ferrure Fitting	 EN 12207	 EN 12208	 EN 12210
Anschlagdichtung Joint de butée Rebate gasket 	1	1	0	C1
	2	1	0	C1
	3	1	0	C2
Doppel-Anschlagdichtung Joint de base double Double rebate gasket 	1	1	1A	C1
	2	1	1A	C1
	3	2	2A	C2
Senkdichtung Joint seuil Drop seal 	1	1	0	C1
	2	1	0	C1
	3	1	0	C2
Aufbaudichtung Joint de contact Ramp seal 	1	0	0	C1
	2	0	0	C1
	3	1	0	C2

1 Fallenriegel-Schloss  
 Serrure à mortaiser  
 Latch and bolt lock

2 Schloss mit Obenverriegelung  
 Serrure avec verrouillage supérieur  
 Lock with top locking point





3 Mehrfachverriegelungs-Schloss  
 Serrure à verrouillage multiple  
 Multipoint lock



Einflügelige Türen,  
 einwärts öffnend,  
 Flügelhöhe ≤ 3000 mm

Porte à un vantail,  
 ouvrant vers l'intérieur,  
 hauteur du vantail ≤ 3000 mm

Single leaf door,  
 inward opening,  
 leaf height ≤ 3000 mm

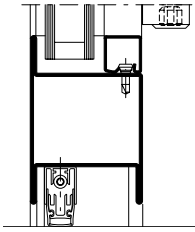
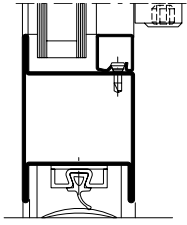
Variante		Beschlag Ferrure Fitting	 EN 12207	 EN 12208	 EN 12210
Senkdichtung Joint seuil Drop seal		❶	1	0	C1
		❷	1	0	C1
		❸	1	0	C2
Auflaufdichtung Joint de contact Ramp seal		❶	0	0	C1
		❷	0	0	C1
		❸	1	0	C2

❶ Fallenriegel-Schloss  
 Serrure à mortaiser  
 Latch and bolt lock



❷ Schloss mit Obenverriegelung  
 Serrure avec verrouillage supérieur  
 Lock with top locking point

❸ Mehrfachverriegelungs-Schloss  
 Serrure à verrouillage multiple  
 Multipoint lock

Zweiflügelige Türen,  
 auswärts öffnend,  
 Flügelhöhe ≤ 2200 mm

Porte à deux vantaux,  
 ouvrant vers l'extérieur,  
 hauteur du vantail ≤ 2200 mm

Double leaf door,  
 outward opening,  
 leaf height ≤ 2200 mm

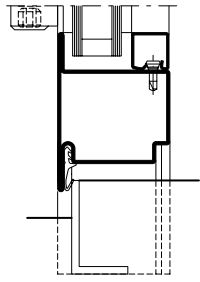
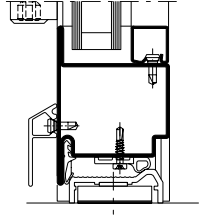
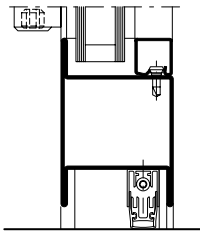
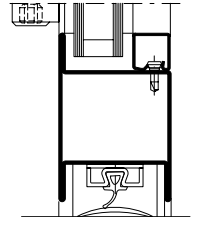
Variante	Beschlag Ferrure Fitting	 EN 12207	 EN 12208	 EN 12210
Anschlagdichtung Joint de butée Rebate gasket 	1	2	1A	C2
	2	2	2A	C2
	3	2	2A	C3
Doppel-Anschlagdichtung Joint de base double Double rebate gasket 	1	2	2A	C2
	2	2	2A	C2
	3	3	3A	C3
Senkdichtung Joint seuil Drop seal 	1	2	1A	C2
	2	2	2A	C2
	3	2	2A	C3
Auflaufdichtung Joint de contact Ramp seal 	1	2	0	C2
	2	2	0	C2
	3	2	0	C3

1 Fallenriegel-Schloss  
 Serrure à mortaiser  
 Latch and bolt lock





2 Schloss mit Obenverriegelung  
 Serrure avec verrouillage supérieur  
 Lock with top locking point

3 Mehrfachverriegelungs-Schloss  
 Serrure à verrouillage multiple  
 Multipoint lock

Zweiflügelige Türen,  
 einwärts öffnend,  
 Flügelhöhe ≤ 2200 mm

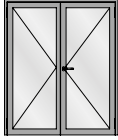
Porte à deux vantaux,  
 ouvrant vers l'intérieur,  
 hauteur du vantail ≤ 2200 mm

Double leaf door,  
 inward opening,  
 leaf height ≤ 2200 mm

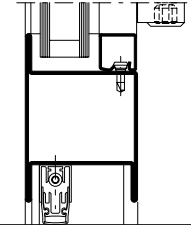
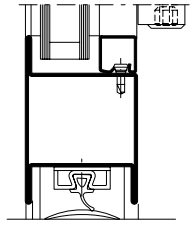
Variante		Beschlag Ferrure Fitting	 EN 12207	 EN 12208	 EN 12210
Senkdichtung Joint seuil Drop seal		❶	2	0	C2
		❷	2	0	C2
		❸	2	0	C3
Auflaufdichtung Joint de contact Ramp seal		❶	2	0	C2
		❷	2	0	C2
		❸	2	0	C3

❶ Fallenriegel-Schloss  
 Serrure à mortaiser  
 Latch and bolt lock



❷ Schloss mit Obenverriegelung  
 Serrure avec verrouillage supérieur  
 Lock with top locking point

❸ Mehrfachverriegelungs-Schloss  
 Serrure à verrouillage multiple  
 Multipoint lock

Zweiflügelige Türen,  
 auswärts öffnend,  
 Flügelhöhe ≤ 3000 mm

Porte à deux vantaux,  
 ouvrant vers l'extérieur,  
 hauteur du vantail ≤ 3000 mm

Double leaf door,  
 outward opening,  
 leaf height ≤ 3000 mm

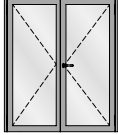
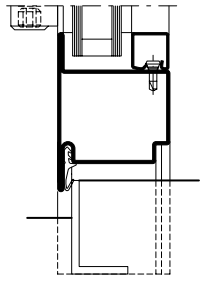
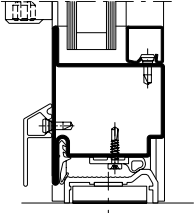
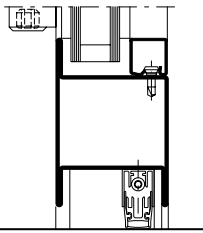
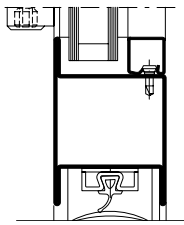
Variante	Beschlag Ferrure Fitting	 EN 12207	 EN 12208	 EN 12210	
					
Anschlagdichtung Joint de butée Rebate gasket		1	0	0	C1
		2	0	0	C1
		3	1	0	C2
Doppel-Anschlagdichtung Joint de base double Double rebate gasket		1	1	0	C1
		2	1	0	C1
		3	2	0	C2
Senkdichtung Joint seuil Drop seal		1	0	0	C1
		2	0	0	C1
		3	1	0	C2
Auflaufdichtung Joint de contact Ramp seal		1	0	0	C1
		2	0	0	C1
		3	1	0	C2

1 Fallenriegel-Schloss  
 Serrure à mortaiser  
 Latch and bolt lock





2 Schloss mit Obenverriegelung  
 Serrure avec verrouillage supérieur  
 Lock with top locking point

3 Mehrfachverriegelungs-Schloss  
 Serrure à verrouillage multiple  
 Multipoint lock

Zweiflügelige Türen,  
 einwärts öffnend,  
 Flügelhöhe ≤ 3000 mm

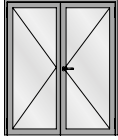
Porte à deux vantaux,  
 ouvrant vers l'intérieur,  
 hauteur du vantail ≤ 3000 mm

Double leaf door,  
 inward opening,  
 leaf height ≤ 3000 mm

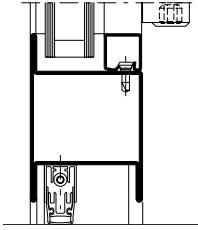
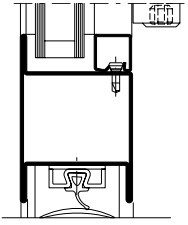
Variante		Beschlag Ferrure Fitting	 EN 12207	 EN 12208	 EN 12210
Senkdichtung Joint seuil Drop seal		1	0	0	C1
		2	0	0	C1
		3	1	0	C2
Auflaufdichtung Joint de contact Ramp seal		1	0	0	C1
		2	0	0	C1
		3	1	0	C2

**U<sub>f</sub>-Werte**  
(nach EN ISO 10077-2:2018-01)

**Valeurs U<sub>f</sub>**  
(selon EN ISO 10077-2:2018-01)

**U<sub>f</sub> values**  
(according to  
EN ISO 10077-2:2018-01)

Auf den folgenden Seiten finden Sie die U<sub>f</sub>-Werte für die verschiedenen Anwendungen von Jansen-Economy 60.

Vous trouverez les valeurs U<sub>f</sub> pour les différentes applications Jansen-Economy 60 dans les pages qui suivent.

On the following pages you will find the U<sub>f</sub> values for the various applications for Jansen-Economy 60.

Sie basieren auf folgenden Grundlagen:

Elles se basent sur les principes suivants:

They are based on the following:

**Stahl**

- Profile bandverzinkter Stahl, unbeschichtet
- Stahl-Glasleisten
- Trockenverglasung
- Nassverglasung

**Acier**

- Profilés en bande d'acier zingué, sans revêtement
- Parcloses en acier
- Vitrage à sec
- Vitrage à mastic



**Steel**

- Strip galvanised steel profiles, uncoated
- Steel glazing beads
- Glazing with dry glazing
- Glazing with sealing

**U<sub>f</sub>-Werte**  
 (nach EN ISO 10077-2:2018-01)

**Valeurs U<sub>f</sub>**  
 (selon EN ISO 10077-2:2018-01)

**U<sub>f</sub> values**  
 (according to EN ISO 10077-2:2018-01)

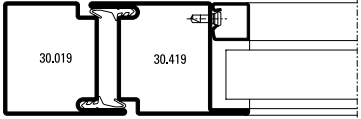
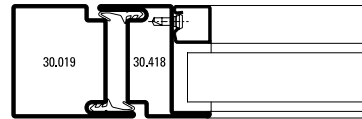
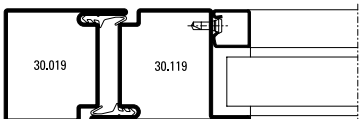
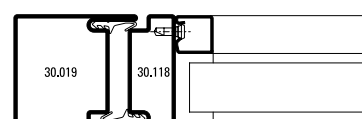
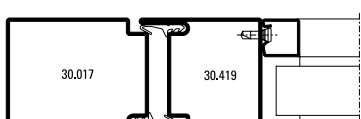
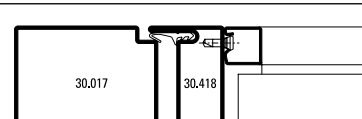
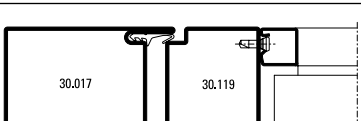
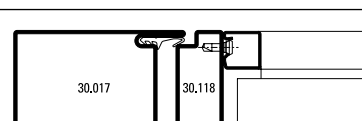
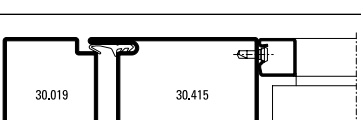
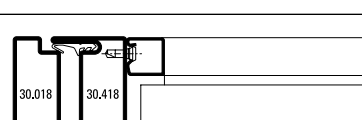
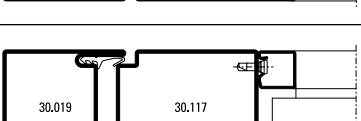
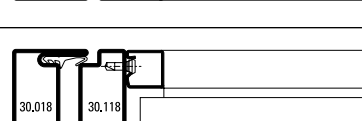
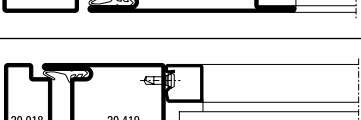
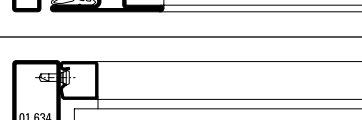
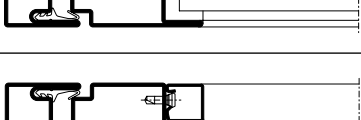
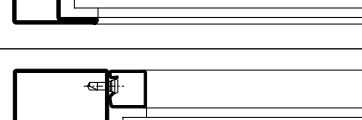
 Füllelementstärken Elements de remplissages Infill elements ≥ 24 mm		 Füllelementstärken Elements de remplissages Infill elements ≥ 24 mm	
	5,5 W/m <sup>2</sup> K		5,7 W/m <sup>2</sup> K
	5,6 W/m <sup>2</sup> K		5,8 W/m <sup>2</sup> K
	5,3 W/m <sup>2</sup> K		5,5 W/m <sup>2</sup> K
	5,3 W/m <sup>2</sup> K		5,5 W/m <sup>2</sup> K
	5,3 W/m <sup>2</sup> K		6,0 W/m <sup>2</sup> K
	5,3 W/m <sup>2</sup> K		6,1 W/m <sup>2</sup> K
	5,6 W/m <sup>2</sup> K		6,9 W/m <sup>2</sup> K
	5,7 W/m <sup>2</sup> K		6,1 W/m <sup>2</sup> K

**U<sub>f</sub>-Werte**  
 (nach EN ISO 10077-2:2018-01)

**Valeurs U<sub>f</sub>**  
 (selon EN ISO 10077-2:2018-01)

**U<sub>f</sub> values**  
 (according to EN ISO 10077-2:2018-01)

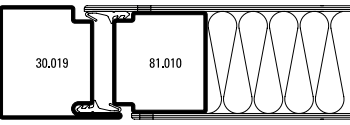
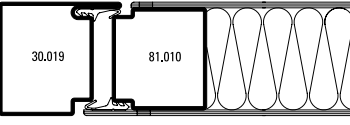
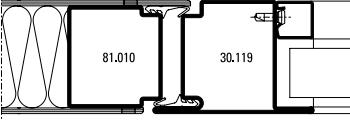
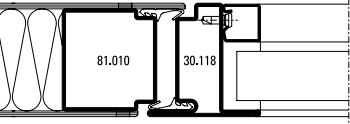
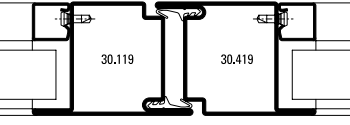
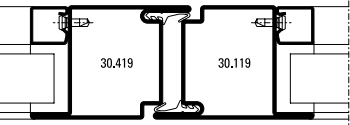
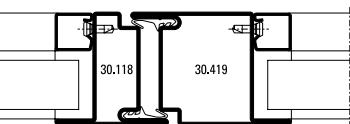
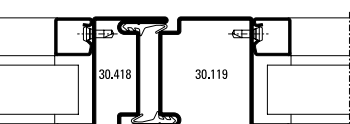
 Füllelementstärken Elements de remplissages Infill elements	≥ 24 mm
	5,3 W/m²K
	5,3 W/m²K
	5,7 W/m²K
	6,0 W/m²K
	5,8 W/m²K
	5,8 W/m²K
	6,1 W/m²K
	6,1 W/m²K

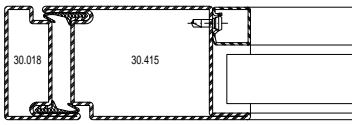
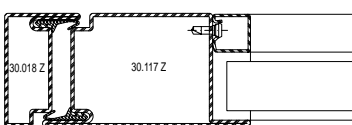
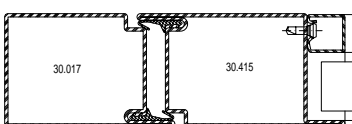
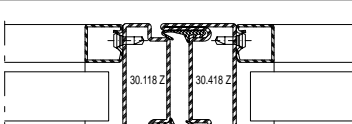
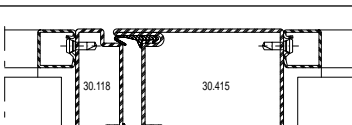
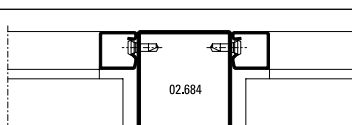
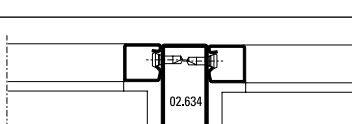
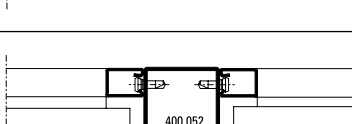
 Füllelementstärken Elements de remplissages Infill elements	≥ 24 mm
	5,3 W/m²K
	5,4 W/m²K
	5,1 W/m²K
	6,5 W/m²K
	5,7 W/m²K
	6,3 W/m²K
	7,2 W/m²K
	6,4 W/m²K



**U<sub>f</sub>-Werte**  
 (nach EN ISO 10077-2:2018-01)

**Valeurs U<sub>f</sub>**  
 (selon EN ISO 10077-2:2018-01)

**U<sub>f</sub> values**  
 (according to EN ISO 10077-2:2018-01)

	Füllelementstärken Elements de remplissages Infill elements  ≥ 24 mm
	5,5 W/m²K
	5,7 W/m²K
	5,5 W/m²K
	5,3 W/m²K
	5,3 W/m²K

	Füllelementstärken Elements de remplissages Infill elements  ≥ 24 mm
	5,8 W/m²K
	6,0 W/m²K
	5,4 W/m²K
	5,1 W/m²K

**U<sub>f</sub>-Werte**  
 (nach EN ISO 10077-2:2018-01)

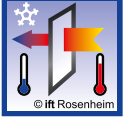
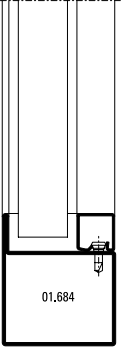
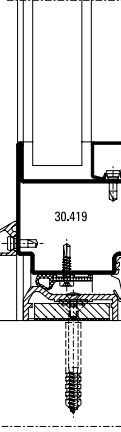
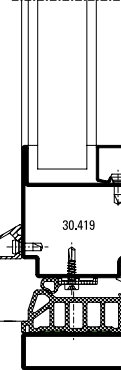
 Füllelementstärken Elements de remplissages Infill elements ≥ 24 mm	
 01.684	6,1 W/m <sup>2</sup> K
 30.419	6,3 W/m <sup>2</sup> K
 30.419	5,6 W/m <sup>2</sup> K

**Valeurs U<sub>f</sub>**  
 (selon EN ISO 10077-2:2018-01)

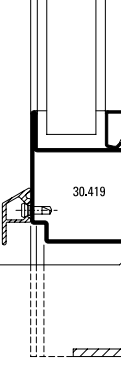
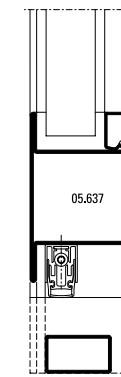
 Füllelementstärken Elements de remplissages Infill elements ≥ 24 mm	
 30.419	6,3 W/m <sup>2</sup> K
 05.637	5,6 W/m <sup>2</sup> K

**U<sub>f</sub> values**  
 (according to EN ISO 10077-2:2018-01)

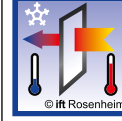
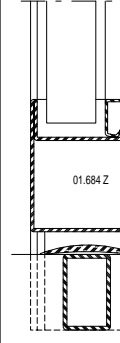
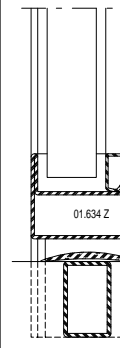
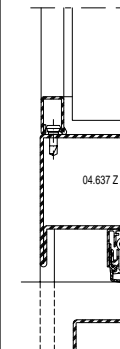
 Füllelementstärken Elements de remplissages Infill elements ≥ 24 mm	
 01.684 Z	6,1 W/m <sup>2</sup> K
 01.634 Z	6,8 W/m <sup>2</sup> K
 04.637 Z	5,5 W/m <sup>2</sup> K

**U<sub>f</sub>-Werte**  
 (nach EN ISO 10077-2:2018-01)

**Valeurs U<sub>f</sub>**  
 (selon EN ISO 10077-2:2018-01)

**U<sub>f</sub> values**  
 (according to EN ISO 10077-2:2018-01)

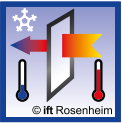
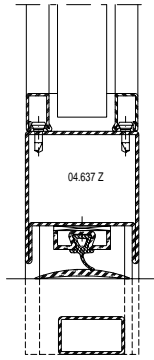
	Füllelementstärken Elements de remplissages Infill elements
	≥ 24 mm
	5,6 W/m <sup>2</sup> K

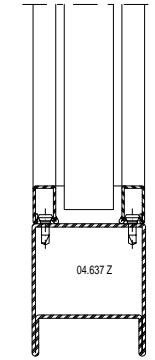
	Füllelementstärken Elements de remplissages Infill elements
	≥ 24 mm
	5,6 W/m <sup>2</sup> K

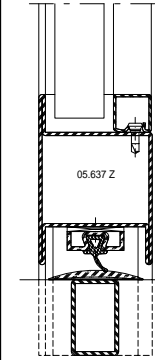
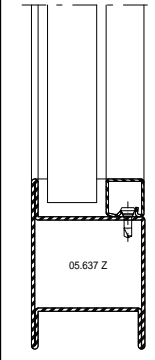
	Füllelementstärken Elements de remplissages Infill elements
	≥ 24 mm
	5,7 W/m <sup>2</sup> K
	5,7 W/m <sup>2</sup> K

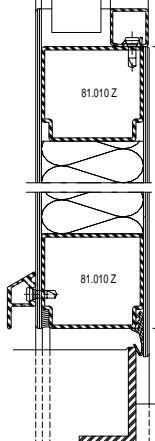
	4,4 W/m <sup>2</sup> K
---	------------------------

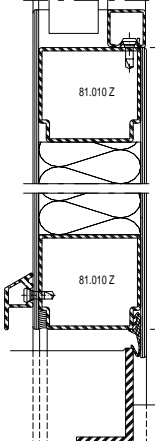
	5,2 W/m <sup>2</sup> K
---	------------------------



## Schallschutz

### Ausführungsvarianten

Die nachfolgende Typenübersicht ergibt einen Überblick über die beurteilten Varianten.

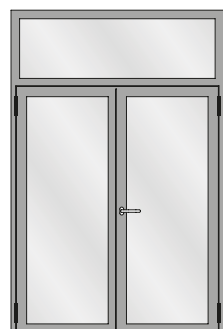
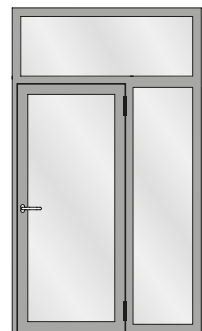
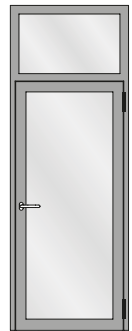
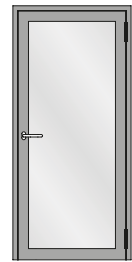

## Isolation phonique

### Modèles

L'aperçu des types suivant fournit une vue d'ensemble des variantes examinées.

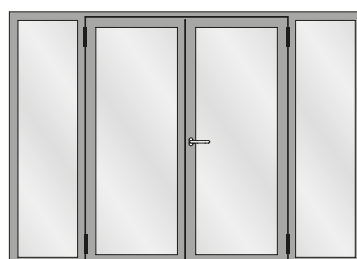
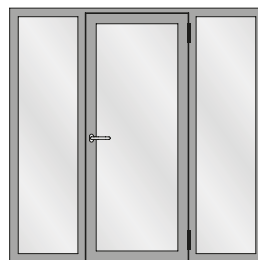
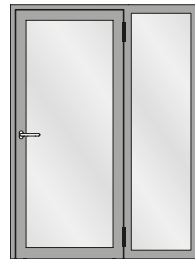
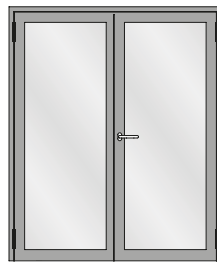

## Sound insulation

### Design range

The following overview of types provides an overview of the evaluated designs.

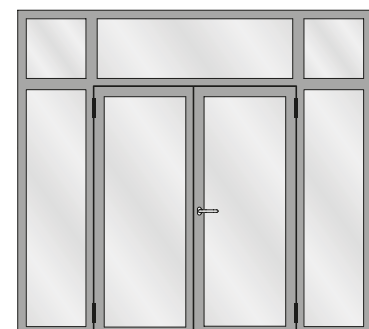
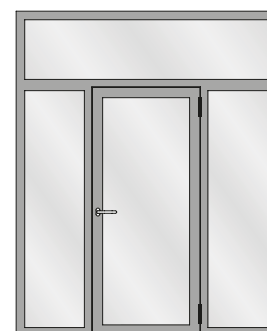

Schallschutz

Isolation phonique

Sound insulation

Tabelle A1

Korrekturtabelle für Jansen-Economy-Türen mit Glasfüllungen

Tableau A1

Tableau de correction pour les portes Jansen-Economy avec vitrage

Table A1

Correction table for Jansen-Economy doors with glass

	1	2	3	4	5	6	7	8	9	10	11
	<b>Türe</b> mit zwei absenkba- ren Bodendichtungen <b>Porte</b> avec deux joint seuil automatique <b>Door</b> with two threshold gaskets that can be lowered	<b>Glas</b>  <b>Verre</b>  <b>Glass</b>	<b>Korrekturen</b>  <b>Corrections</b>  <b>Corrections</b>								
	$R_{w(C, Ctr)}$ dB	$R_{w, P, Glas}$ dB	$K_S$ dB	$K_{FV}$ dB	$K_{Nass}$ dB	$K_{1aB}$ dB	$K_{W/S}$ dB	$K_{G 0,4}$ dB	$K_{G 1,8}$ dB	$K_{G 2,6}$ dB	$K_{G 3,2}$ dB
1	32 (-1; -5)	31	0	-1	0	0	0	0	-1	-2	-3
2	33 (-1; -5)	32	0	-1	0	0	0	0	-1	-2	-3
3	35 (-1; -5)	34	0	-1	0	0	0	0	-1	-2	-3
4	36 (-2; -5)	35	0	-1	-1	0	0	0	-1	-2	-3
5	37 (-2; -5)	37	0	0	-1	0	-1	0	-1	-2	-3
6	38 (-2; -5)	39	0	0	-1	-1	-1	0	-1	-2	-3
7	39 (-2; -5)	40	0	0	-1	-1	-1	0	-1	-2	-3
8	40 (-2; -5)	41	0	0	-1	-1	-2	-1	-1	-2	-3
9	41 (-2; -5)	42	0	0	-1	-1	-2	-2	-1	-2	-3
10	42 (-2; -5)	43	-1	0	-1	-1	-2	-2	-1	-2	-3
11	42 (-2; -5)	44	-1	0	-1	-1	-2	-2	-1	-2	-3
12	43 (-2; -5)	45	-1	+1	-1	-1	-3	-3	-1	-2	-3
13	44 (-2; -5)	49	-1	+1	-1	-2	-3	-3	-1	-2	-3

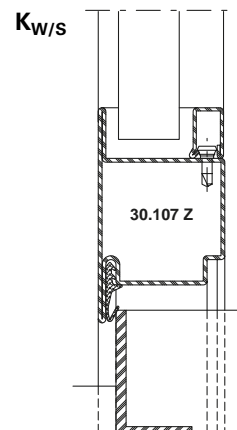
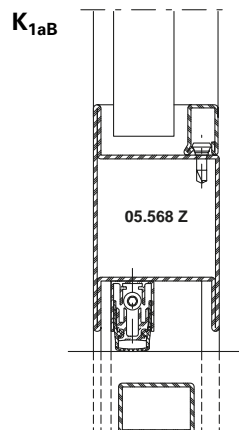
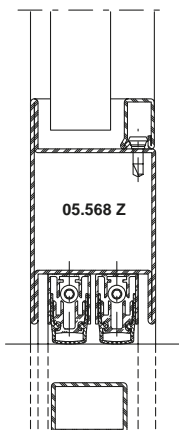

**Schallschutz**

**Isolation phonique**

**Sound insulation**

*Der aus der Tabelle A1 abzulesende Wert für die Schalldämmung  $R_{w, Tür}$  beträgt:*

*La valeur à relever sur le tableau A1 concernant l'isolement contre les sons aériens  $R_{w, Porte}$  est la suivante:*

*The value taken from table A1 for the sound insulation  $R_{w, Door}$  is:*

$$R_{w, Tür} = R_w + K_S + K_{FV} + K_{Nass} + K_{1aB} + K_{W/S} + K_{Band} + K_{G 0,4} + K_{G 1,8} + K_{G 2,6} + K_{G 3,2} \text{ dB}$$

- $R_w$**  bewertetes Schalldämm-Mass der Türe in Abhängigkeit von der Schalldämmung  $R_{w,P, Glas}$
- $R_{w,P, Glas}$**  bewertetes Schalldämm-Mass der Verglasung (Prüfwert nach ISO 140-3, mit Prüfnachweis einer PÜZ-Stelle). Alternativ können Tabellenwerte nach DIN EN 12758, Abschnitt 6 verwendet werden
- $K_S$**  Korrekturwert für zweiflügelige Türen
- $K_{FV}$**  Korrekturwert für Festverglasungen mit erhöhtem Scheibenanteil
- $K_{Nass}$**  Korrekturwert für Nassverglasung
- $K_{1aB}$**  Korrekturwert für Türen mit einer absenkbaren Bodendichtung
- $K_{Band}$**  Korrekturwert bei Verwendung von Anschlagbändern, die eine Dichtungsebene unterbrechen ( $K_{Band} = - 0,5 \text{ dB pro Band}$ )
- $K_{W/S}$**  Korrekturwert für Türen mit einer Anschlagsschwelle
- $K_{G 0,4}$**  Korrekturwert für Einzelscheiben mit einer Glasfläche  $\leq 0,4 \text{ m}^2$ . Die Korrektur gilt auch für Konstruktionen mit glasteilenden Sprossen.
- $K_{G 1,8}$**  Korrekturwert für Einzelscheiben mit einer Glasfläche  $\geq 1,8 \text{ m}^2$
- $K_{G 2,6}$**  Korrekturwert für Einzelscheiben mit einer Glasfläche  $\geq 2,6 \text{ m}^2$
- $K_{G 3,2}$**  Korrekturwert für Einzelscheiben mit einer Glasfläche  $\geq 3,2 \text{ m}^2$

- $R_w$**  Mesure d'isolement contre les sons aériens des portes évaluée suivant l'isolement phonique  $R_{w,P, Glas}$
- $R_{w,P, Glas}$**  Cote d'isolement acoustique du vitrage évalué (valeur contrôlée selon ISO 140-3 avec certificat d'un bureau de contrôle, de surveillance ou de certification). Il est également possible d'utiliser les valeurs selon le tableau DIN EN 12758, section 6
- $K_S$**  Valeur de correction pour portes à deux vantaux
- $K_{FV}$**  Valeur de correction pour vitrages fixes à fort pourcentage de vitre
- $K_{Nass}$**  Valeur de correction pour vitrage avec mastic
- $K_{1aB}$**  Valeur de correction pour portes avec un joint seuil automatique
- $K_{Band}$**  Valeur corrective en cas d'utilisation de paumelles qui interrompent un plan d'étanchéité ( $K_{Band} = - 0,5 \text{ dB par paumelle}$ )
- $K_{W/S}$**  Valeur de correction pour portes avec un seuil de butée
- $K_{G 0,4}$**  Valeur de correction pour vitres individuelles avec une surface vitrée  $\leq 0,4 \text{ m}^2$ . La correction s'applique aussi aux constructions à meneaux séparant les vitres.
- $K_{G 1,8}$**  Valeur de correction pour vitres individuelles avec surface vitrée  $\geq 1,8 \text{ m}^2$
- $K_{G 2,6}$**  Valeur de correction pour vitres individuelles avec surface vitrée  $\geq 2,6 \text{ m}^2$
- $K_{G 3,2}$**  Valeur de correction pour vitres individuelles avec surface vitrée  $\geq 3,2 \text{ m}^2$

- $R_w$**  Airborne sound reduction index of doors depending on the sound insulation  $R_{w,P, Glas}$
- $R_{w,P, Glas}$**  Airborne sound reduction index (test value in accordance with ISO 140-3, with a test certificate from a recognised testing, inspection or certification body). Alternatively, the tabulated values in DIN EN 12758, Section 6 may be used
- $K_S$**  Correction value for double-leaf doors
- $K_{FV}$**  Correction value for fixed glazing with increased proportion of pane
- $K_{Nass}$**  Correction value for glazing with sealing
- $K_{1aB}$**  Correction value for doors with a threshold gasket that can be lowered
- $K_{Band}$**  Correction value when using hinges that interrupt a sealing plane ( $K_{Band} = - 0.5 \text{ dB per hinge}$ )
- $K_{W/S}$**  Correction value for doors with a rebate threshold
- $K_{G 0,4}$**  Correction value for single panes with a glass area  $\leq 0,4 \text{ m}^2$ . The correction also applies to buildings with glazing bars
- $K_{G 1,8}$**  Correction value for single panes with a glass area  $\geq 1,8 \text{ m}^2$
- $K_{G 2,6}$**  Correction value for single panes with a glass area  $\geq 2,6 \text{ m}^2$
- $K_{G 3,2}$**  Correction value for single panes with a glass area  $\geq 3,2 \text{ m}^2$



Jansen AG

**Steel Systems**  
Industriestrasse 34  
9463 Oberriet  
Schweiz  
[jansen.com](http://jansen.com)

**JANSEN**  
**METALFORM**



# Jansen-Economy 60 Türen

Türen aus Stahl

# Portes Jansen-Economy 60

Portes en acier

# Jansen-Economy 60 doors

Doors in steel

Grafische Planungsdaten wie z.B. Anwendungsbeispiele, Konstruktionsdetails, Anschlüsse am Bau, die in unseren physischen oder elektronischen Dokumentationsunterlagen enthalten sind, sind schematische Darstellungen. Gleiches gilt für digitale Medien wie CAD Dateien oder BIM Modelle.

Sie sollen den ausführenden Metallbauer und/oder Fachplaner bei der Planung und Ausführung eines Projektes unterstützen. Sie sind im konkreten Anwendungsfall durch den ausführenden Metallbauer und/oder Fachplaner auf die Verwendbarkeit im konkreten betroffenen Projekt hinsichtlich rechtlichen/regulatorischen aber auch technischen objektspezifischen Anforderungen zu überprüfen und ggfs. eigenverantwortlich anzupassen.

Bei der Überprüfung, der spezifischen Planung und der Umsetzung sind die objektspezifischen Rahmenbedingungen (Material der Bausubstanz, Dimension des Einbauelements, Farbe, Exposition, Lasteinwirkung, etc.) sowie der geltende Stand der Technik einschliesslich aller anwendbaren Normen und technischen Richtlinien eigenverantwortlich zu beachten.

Falls das vorliegende Dokument Differenzen zur aktuellen deutschen Version (Artikel Nr. K1214237) aufweist, gilt in jedem Fall der deutsche Originaltext in der jeweils geltenden Fassung im Jansen Docu Center.

Alle Ausführungen dieser Dokumentation haben wir sorgfältig und nach bestem Wissen zusammengestellt. Wir können aber keine Verantwortung für die Benutzung der vermittelten Vorschläge und Daten übernehmen. Wir behalten uns technische Änderungen ohne Vorankündigung vor.

Les données de planification graphiques, comme les exemples d'application, détails de construction et raccordements au bâtiment, fournies dans notre documentation physique et numérique sont des représentations schématiques. Il en va de même pour les médias numériques comme les fichiers CAD ou modèles BIM.

Leur but est de faciliter la planification et réalisation d'un projet par les constructeurs métalliques et/ou concepteurs. Concrètement, elles doivent être vérifiées par le constructeur métallique et/ou le concepteur et, le cas échéant, modifiées de son propre chef pour s'assurer qu'elles concordent avec le projet concerné et qu'elles répondent aux exigences techniques spécifiques ainsi qu'aux dispositions légales et réglementaires.

Lors de la vérification, de la planification spécifique et de la mise en œuvre, il y a lieu de tenir compte des conditions spécifiques à l'objet (matériaux du bâtiment, dimension de l'élément d'insert, couleur, exposition, effet de charge, etc.) ainsi que de l'état actuel de la technique, y compris toutes les normes et directives techniques applicables.

En cas de divergence entre le présent document et la version allemande (no d'article K1214237), c'est dans tous les cas le texte original allemand qui prévaut dans sa version actuelle disponible dans le Jansen Docu Center.

Nous avons apporté le plus grand soin à l'élaboration de cette documentation. Cependant, nous déclinons toute responsabilité pour l'utilisation faite de nos propositions et de nos données.

Nous nous réservons le droit de procéder à des modifications techniques sans préavis.

Graphical planning data such as application examples, construction details, connections on site that are contained in our physical or electronic documentation components are schematic representations. The same applies to digital media such as CAD files or BIM models.

They are intended to support the metal worker and/or design engineer in planning and executing projects. In the specific case of application they are to be checked by the metal worker and/or design engineer in terms of their usability in the specific project concerned with regard to legal/regulatory and technical property-specific requirements and adjusted if necessary at the latter's own responsibility.

The property-specific underlying conditions (construction material, dimensions of installation element, colour, exposure, load effect etc.) and current state of the art including all applicable norms and technical guidelines are to be taken into consideration at the metal worker and/or design engineer's own responsibility during the review, specific planning and implementation.

If there are any differences between this document and the current German version (item number K1214237), the latest version of the original German text in the Jansen Docu Center shall prevail.

All the information contained in this documentation is given to the best of our knowledge and ability. However, we decline all responsibility for the use made of these suggestions and data.

We reserve the right to effect technical modifications without prior warning.

<b>Inhaltsverzeichnis</b> <b>Sommaire</b> <b>Content</b>	Jansen-Economy 60 Türen Jansen-Economy 60 portes Jansen-Economy 60 doors	<b>2</b>	
<b>Systemübersicht</b> Merkmale Leistungseigenschaften Systemausführungen Typenübersicht	<b>Sommaire du système</b> Caractéristiques Caractéristiques de performance Exécutions de système Sommaire des types		<b>Summary of system</b> Characteristics Performance characteristics System versions Summary of types
<b>Profilsortiment</b>	<b>Assortiment de profilé</b>	<b>Range of profiles</b>	<b>14</b>
<b>Beispiele</b> Schnittpunkte Konstruktionsdetails Anschlüsse am Bau	<b>Exemples</b> Coupes de détails Détails de construction Raccords au mur	<b>Examples</b> Section details Construction details Attachment to structure	
<b>Leistungseigenschaften</b>	<b>Caractéristiques de performance</b>	<b>Performance characteristics</b>	<b>36</b>







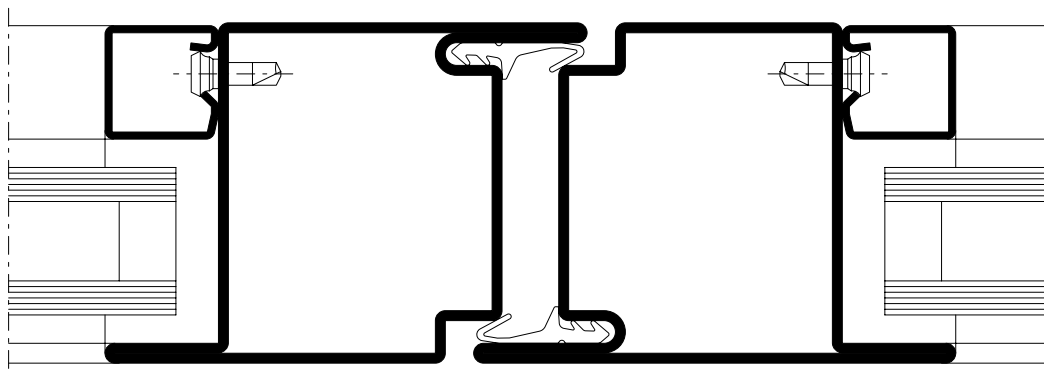

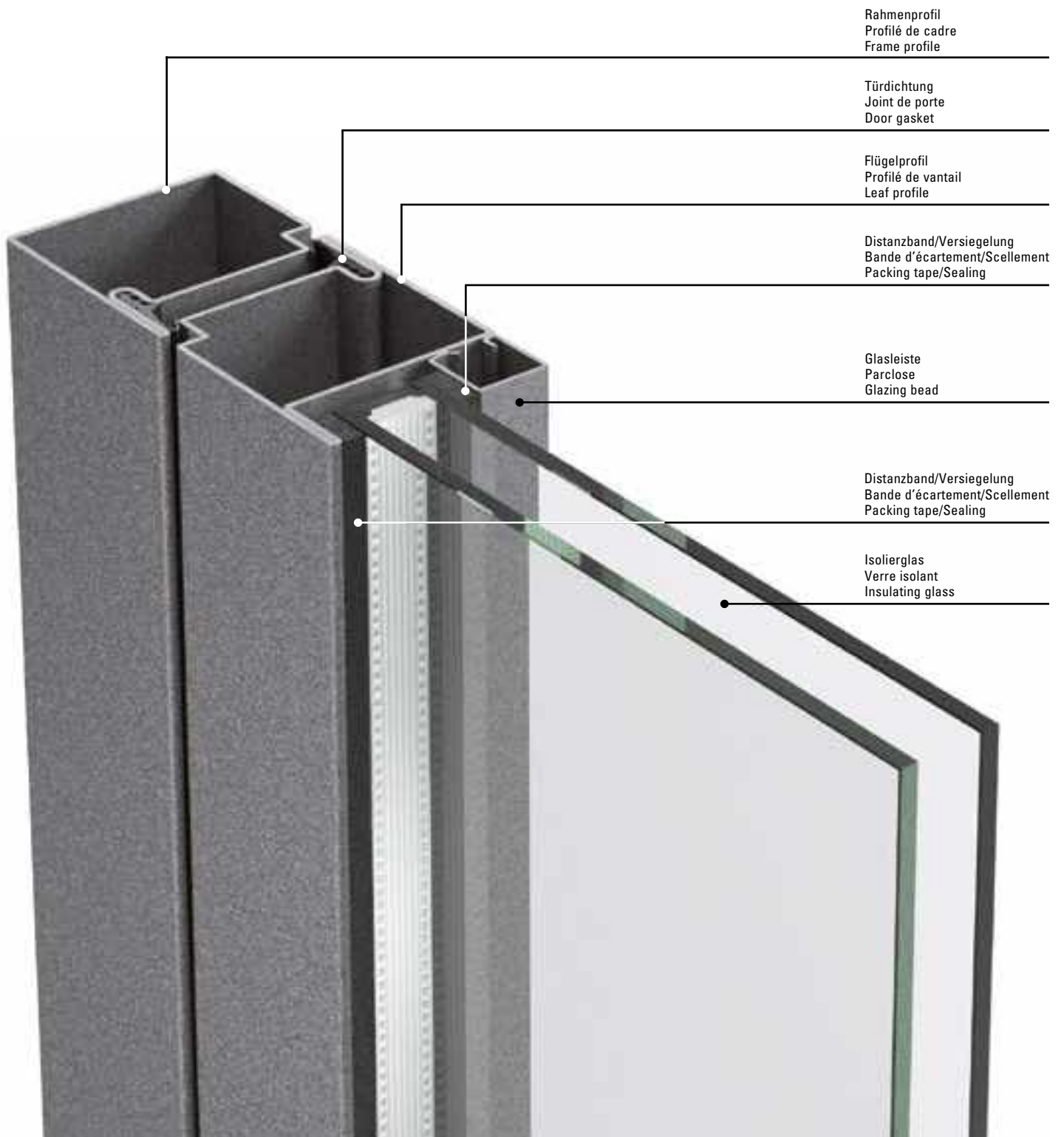

**Merkmale**  
**Caractéristiques**  
**Characteristics**





Jansen-Economy 60 Türen  
Jansen-Economy 60 portes  
Jansen-Economy 60 doors

- Stahlsystem für Türen und Festverglasungen
- Bautiefe 60 mm, innen und aussen flächenbündig
- Schmale Ansichtsbreiten: Rahmen und Flügel ab 105 mm Stulppartie 150 mm
- Ein- und zweiflüglige Türen, nach innen und aussen öffnend, mit Oberlicht oder Festverglasung kombinierbar
- Türflügel bis 1465 x 3000 mm (BxH), Flügelgewicht bis 230 kg
- Füllelementstärke von 5 bis 36 mm, Glaseinbau mittels Trocken- oder Nassverglasung
- Systemprüfungen nach Produktnorm EN 14351-1
- Stahlprofile blank oder bandverzinkt
- Grosses Sortiment an systemgeprüften Türbeschlägen
- Barrierefreie Schwellenausbildungen
- Geeignet für Pulver- und Nasslackbeschichtungen
- Système en acier pour portes et vitrages fixes
- Profondeur de montage 60 mm, montage à fleur à l'intérieur et à l'extérieur
- Fines largeurs de face: Cadre et vantaux à partir de 105 mm Partie tête 150 mm
- Portes à un et deux vantaux, ouverture vers l'intérieur et vers l'extérieur, combinables avec imposte ou vitrage fixe
- Vantaux de porte jusqu'à 1465 x 3000 mm (LaxH), poids du vantail jusqu'à 230 kg
- Élément de remplissage de 5 à 36 mm d'épaisseur, Montage du vitrage à sec ou à silicone
- Contrôles des systèmes selon la norme produit EN 14351-1
- Profilés en acier brut ou galvanisé en continu
- Grand assortiment de ferrures de porte homologuées
- Formes de seuil sans barrière
- Convient aux revêtements par poudre ou peinture liquide
- Steel system for doors and fixed glazing
- 60 mm basic depth, flush-fitted on the inside and outside
- Narrow face widths: Frame and leaf from 105 mm Meeting stile assembly 150 mm
- Single and double-leaf doors, inward and outward-opening, can be combined with toplight or fixed glazing
- Door leaf up to 1465 x 3000 mm (WxH), leaf weight up to 230 kg
- Infill unit thickness of 5 to 36 mm, Glazing installed by means of dry or wet glazing
- System tests in accordance with the product standard EN 14351-1
- Raw finish or pre-galvanised steel profiles
- Large range of system-tested door fittings
- Easy-access thresholds
- Suitable for powder and wet paint coating





Norm	Eigenschaft Caractéristique Characteristic	Klassifizierung/Wert Classification / Valeur Classification / Value										
 EN 12210	<b>Widerstandsfähigkeit bei Windlast</b> <b>Résistance à la pression du vent</b> <b>Resistance to wind load</b>	npd	1 (400)	2 (800)	3 (1200)	4 (1600)	5 (2000)	Exxx (>2000)				
 EN 12208	<b>Schlagregendichtheit</b> <b>Étanchéité à la pluie battante</b> <b>Watertightness</b>	npd	1A (0)	2A (50)	3A (100)	4A (150)	5A (200)	6A (250)	7A (300)	8A (450)	9A (600)	Exxx (>750)
 EN ISO 10140	<b>Schalldämmung</b> $R_w$ (C, $C_{tr}$ ) (dB) <b>Isolation phonique</b> $R_w$ (C, $C_{tr}$ ) (dB) <b>Sound insulation</b> $R_w$ (C, $C_{tr}$ ) (dB)	npd	bis $R_w$ 44 dB (-2; -5) jusqu'à $R_w$ 44 dB (-2; -5) up to $R_w$ 44 dB (-2; -5)									
 EN ISO 10077-2	<b>Wärmedurchgangskoeffizient</b> $U_f$ (W/(m <sup>2</sup> ·K)) <b>Transmission thermique</b> $U_f$ (W/(m <sup>2</sup> ·K)) <b>Thermal production</b> $U_f$ (W/(m <sup>2</sup> ·K))	npd	ab 5.65 W/m <sup>2</sup> K à partir de 5.65 W/m <sup>2</sup> K from 5.65 W/m <sup>2</sup> K									
 EN 12207	<b>Luftdurchlässigkeit</b> <b>Perméabilité à l'air</b> <b>Air permeability</b>	npd	1 (150)		2 (300)		3 (600)		4 (600)			
 EN 1192	<b>Klassifizierung der Festigkeitsanforderungen</b> <b>Classification des exigences de résistance méc.</b> <b>Classification of strength requirements</b>	npd	1		2		3		4			
 EN 1627	<b>Einbruchhemmung</b> <b>Anti-effraction</b> <b>Burglar resistance</b>	npd	1		2		3		4		5	6
 EN 1522	<b>Durchschusshemmung</b> <b>Résistance aux balles</b> <b>Bullet proofing</b>	npd	FB1	FB2	FB3	FB4	FB5	FB6	FB7	FSG		
 EN 1191 EN 1603	<b>Dauerfunktionsprüfung</b> <b>Durabilité mécanique</b> <b>Mechanical durability</b>	D	1 5'000	2 10'000	3 20'000	4 50'000	5 100'000	6 200'000	7 500'000	8 1'000'000		
 EN 179 EN 1125	<b>Fähigkeit zur Freigabe</b> <b>Capacité au déclenchement</b> <b>Ability to release</b>		Anforderung erfüllt Exigence remplie Requirement fulfilled									

Norm	Eigenschaft Caractéristique Characteristic	Klassifizierung/Wert Classification / Valeur Classification / Value			
 EN 12217	<b>Bedienkräfte</b> <b>Forces de manœuvre</b> <b>Operating forces</b>	npd	0	1	2
 EN 1634-3 DIN 18095	<b>Rauchschutz</b> <b>Étanchéité à la fumée</b> <b>Smoke control</b>	S <sub>a</sub> / S <sub>200</sub> / RS			
 EN 16034 EN 13501-2	<b>Selbstschliessung</b> <b>Fermeture automatique</b> <b>Self-closing</b>	C			
 EN 16034	<b>Dauerhaftigkeit der Selbstschliessung gegenüber Alterung (Korrosion)</b> <b>Endurance de la fermeture automatique contre le vieillissement (corrosion)</b> <b>Durability of self-closing against ageing (corrosion)</b>	erzielt atteinte achieved			



### Einbruchhemmende Jansen-Economy 60 Türen

- Türflügelgrößen 1465 x 3000 mm
- Ein- und zweiflügelige Türen, nach innen und aussen öffnend
- Geprüft nach EN 1627
- Panik- und Normalausführung

### Portes anti-effraction Jansen-Economy 60

- Dimensions de vantail de porte 1465 x 3000 mm
- Portes à un/deux vantaux à ouverture vers l'intérieur et l'extérieur
- Contrôlé selon la norme EN 1627
- Exécution panique et exécution normale

### Burglar-resistant Jansen Economy 60 doors

- Door leaf sizes 1465 x 3000 mm
- Single and double-leaf doors, inward and outward opening
- Tested in accordance with EN 1627
- Panic and standard design



### Durchschusshemmende Jansen-Economy 60 Türen

- Türflügelgrößen 1465 x 3000 mm
- Ein- und zweiflügelige Türen, nach innen und aussen öffnend
- Geprüft nach EN 1522

### Portes pare-balles Jansen-Economy 60

- Dimensions de vantail de porte 1465 x 3000 mm
- Portes à un/deux vantaux à ouverture vers l'intérieur et l'extérieur
- Contrôlé selon la norme EN 1522

### Bullet-resistant Jansen Economy 60 doors

- Door leaf sizes 1465 x 3000 mm
- Single and double-leaf doors, inward and outward opening
- Tested in accordance with EN 1522





### **Fluchttürsysteme**

- Verschlussystem für Notausgangstüren nach EN 179
- Verschlussystem für Paniktüren nach EN 1125
- Barrierefreie Türen ohne Schwelle für behindertengerechtes Bauen
- Ein- und zweiflügelige Türen nach innen und aussen öffnend
- Türflügelgrößen bis 1465 x 3000 mm und Flügelgewicht bis 230 kg

### **Systèmes de porte de secours**

- Système de fermeture pour portes de secours selon EN 179
- Système de fermeture pour portes panique selon EN 1125
- Portes sans seuil pour faciliter l'accès aux personnes handicapées
- Portes à un/deux vantaux à ouverture vers l'intérieur et l'extérieur
- Dimensions de vantail de porte jusqu'à 1465 x 3000 mm et poids de vantail jusqu'à 230 kg

### **Emergency exit systems**

- Closing system for emergency exit doors in accordance with EN 179
- Closing system for panic doors in accordance with EN 1125
- Barrier-free doors without threshold for accessible buildings
- Single and double-leaf doors, inward and outward opening
- Door leaf sizes up to 1465 x 3000 mm and leaf weight up to 230 kg



### **Jansen-Economy 60 Fingerschutzüren**

- Keine Quetsch- und Scherstellen nach DIN 18650
- Wartungsarme Bandlager unten und oben
- Geeignet für Gebäude mit starkem Publikumsverkehr
- Geprüft nach EN 14351-1

### **Portes anti-pince-doigts Jansen-Economy 60**

- Absence de zones d'écrasement et de cisaillement selon DIN 18650
- Paliers de paumelle inférieur et supérieur exigeant peu de maintenance
- Adapté à des bâtiments publics fortement fréquentés
- Contrôlé selon la norme EN 14351-1

### **Jansen Economy 60 anti-finger-trap doors**

- No crushing and shearing points as per DIN 18650
- Low-maintenance hinge bush at top and bottom
- Suitable for buildings subject to frequent use by the public
- Tested in accordance with EN 14351-1



### Verblechte Jansen-Economy 60 Türen

- Flächenbündig verblechte Türen
- Geschweisst oder geklebt
- Nach innen und aussen öffnend
- Mit Glasausschnitt möglich

### Portes tôlées Jansen-Economy 60

- Portes tôlées à fleur
- Soudées ou collées
- Ouverture vers l'intérieur et l'extérieur
- Panneau de verre possible

### Jansen Economy 60 sheet metal doors

- Flush-fitted sheet metal doors
- Welded or bonded
- Inward and outward-opening
- Can have glass vision panel



### Jansen-Economy 60 Faltwand

- Nach innen und aussen öffnend
- Leichtgängige, geräuscharme Bedienung
- Schwellenlose Ausführung
- Flügelgewichte bis 100 kg

### Porte repliable Jansen-Economy 60

- Ouverture vers l'intérieur et l'extérieur
- Mobilité silencieuse
- Exécution sans seuil
- Poids de vantail jusqu'à 100 kg

### Jansen Economy 60 folding wall

- Inward and outward-opening
- Smooth and quiet operation
- Design without a threshold
- Vent weights up to 100 kg

## Jansen Docu Center

Die Plattform zum effizienten Arbeiten mit Jansen Dokumentationen. Im Jansen Docu Center stehen alle Produktinformationen jederzeit digital in der aktuellsten Version zur Verfügung: von Architekten-Informationen über Bestell- und Fertigungskatalogen bis hin zu Anleitungen und Prospekten sowie Videos.

Die Inhalte können einfach und schnell aufgerufen werden. Ein für den Anwender komfortables papierloses Arbeiten, das zahlreiche Vorteile bietet.

## Download CAD Daten

**DXF**

**DWG**

Sie können die Zeichnungen in den Formaten DXF und/oder DWG herunterladen. Klicken Sie auf das entsprechende Icon und der Download erfolgt.

Die Hinweise «Artikelbibliothek/Türbeschläge/Fensterbeschläge» bedeuten, dass Sie mit einem Klick die gesamte Artikelbibliothek des entsprechenden Systems herunterladen (Profile, Beschläge, Glasleisten, Zubehör etc.).

## Info und Beratung

Gerne beraten wir Sie persönlich und stehen Ihnen bei Fragen zur Verfügung. Bitte schreiben Sie uns Ihre Anliegen an: [info@jansen.com](mailto:info@jansen.com)

## Jansen Docu Center

La plate-forme pour travailler efficacement avec les documentations Jansen. Le Jansen Docu Center met à votre disposition les informations sur les produits, en format numérique et dans une version actualisée: des catalogues de commande et de fabrication aux instructions et prospectus, en passant par les informations destinées aux architectes et vidéos.

Les contenus sont facilement et rapidement accessibles. Une manière de travailler confortable et offrant de nombreux avantages.

## Télécharger fichiers DAO

**DXF**

**DWG**

Vous pouvez télécharger les dessins aux formats DXF et/ou DWG. Cliquez sur l'icône correspondante et le téléchargement s'effectuera.

Les indications «Bibliothèque des articles/Ferures de porte/Ferrures de fenêtres» signifie que vous téléchargez la totalité de la bibliothèque des articles du système donné (profilés, ferrures, parclofes, accessoires etc.).

## Info et conseils

Nous vous conseillerons volontiers individuellement et sommes à votre disposition si vous avez des questions à poser. Veuillez nous envoyer votre requête à: [info@jansen.com](mailto:info@jansen.com)

## Jansen Docu Center

The platform for working efficiently with Jansen documentation. The latest version of all the product information is available digitally at any time in the Jansen Docu Center – from order and fabrication manuals to architect information, instructions and brochures and videos.

The content can be retrieved quickly and easily. The user can work conveniently without paper, which has numerous benefits.

## Download CAD files

**DXF**

**DWG**

You can download the drawings in DXF and/or DWG format. Click on the relevant icon to begin the download.

The items «Article library/Door fittings/Window fittings» means that you download the entire article library for the corresponding system with one click (profiles, fittings, glazing beads, accessories etc.).

## Information and advice

We would be delighted to provide you with advice in person and are available to answer any questions you may have. Please write to us with your queries at: [info@jansen.com](mailto:info@jansen.com)

Zulassungen/Prüfungen  
Homologations/Essais  
Authorisations/Tests

Jansen-Economy 60 Türen  
Jansen-Economy 60 portes  
Jansen-Economy 60 doors

Elementgrößen  
(Empfehlung für CE-Kennzeichnung)

Dimensions des éléments  
(Recommandation pour le label CE)

Size of elements  
(Recommendation for CE marking)

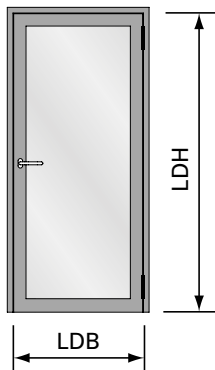

LDB Lichte Durchgangsbreite  
max. 1400 mm  
min. 490 mm

LDB Largeur vide lumière  
max. 1400 mm  
min. 490 mm

LDB Clear opening width  
max. 1400 mm  
min. 490 mm

LDH Lichte Durchgangshöhe  
max. 3000 mm  
min. 1900 mm

LDH Hauteur vide lumière  
max. 3000 mm  
min. 1900 mm

LDH Clear opening height  
max. 3000 mm  
min. 1900 mm

Flügelgewicht max. 230 kg

Poids de vantail max. 230 kg

Weight of leaf max. 230 kg

Zulassungen/Prüfungen  
Homologations/Essais  
Authorisations/Tests

Jansen-Economy 60 Türen  
Jansen-Economy 60 portes  
Jansen-Economy 60 doors

Elementgrößen  
(Empfehlung für CE-Kennzeichnung)

Dimensions des éléments  
(Recommandation pour le label CE)

Size of elements  
(Recommendation for CE marking)

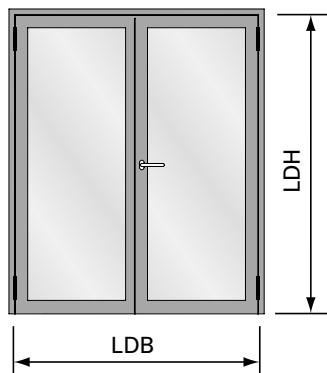

LDB Lichte Durchgangsbreite  
max. 2800 mm  
min. 1000 mm

LDB Largeur vide lumière  
max. 2800 mm  
min. 1200 mm

LDB Clear opening width  
max. 2800 mm  
min. 1000 mm

LDH Lichte Durchgangshöhe  
max. 3000 mm  
min. 1900 mm

LDH Hauteur vide lumière  
max. 3000 mm  
min. 1900 mm

LDH Clear opening height  
max. 3000 mm  
min. 1900 mm

Flügelgewicht max. 230 kg

Poids de vantail max. 230 kg

Weight of leaf max. 230 kg

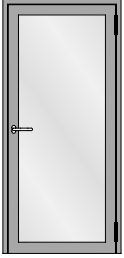

Einflügelige Türe  
Porte à un vantail  
Single leaf door

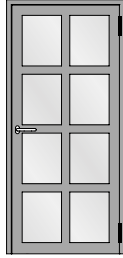

Einflügelige Türe mit Riegel  
Porte à un vantail avec traverse  
Single leaf door with transom

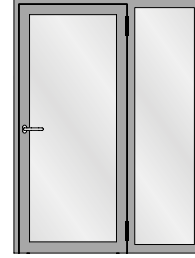

Einflügelige Türe mit Seitenteil  
Porte à un vantail avec partie latérale  
Single leaf door with side light

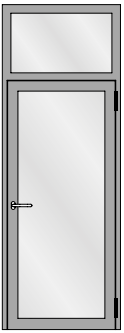

Einflügelige Türe mit Oberlicht  
Porte à un vantail avec imposte  
Single leaf door with top light

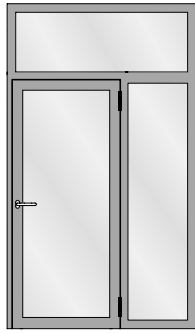

Einflügelige Türe mit Seitenteil und Oberlicht  
Porte à un vantail avec avec partie latérale  
et imposte  
Single leaf door with side light and top light

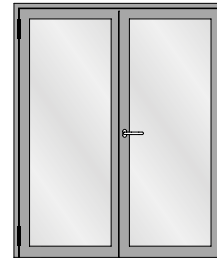

Zweiflügelige Türe  
Porte à deux vantaux  
Double leaf door



Zweiflügelige Türe mit zwei Seitenteilen  
Porte à deux vantaux avec deux parties latérales  
Double leaf door with two side lights

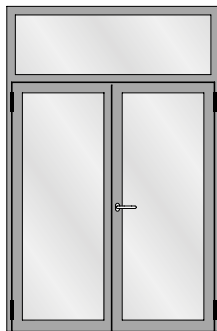

Zweiflügelige Türe mit Oberlicht  
Porte à deux vantaux avec imposte  
Double leaf door with top light

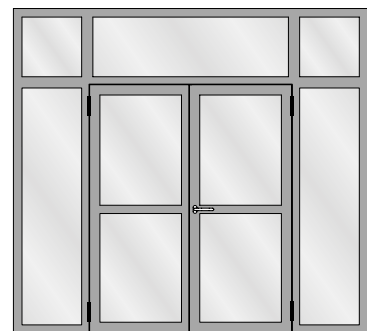

Zweiflügelige Türe mit zwei Seitenteilen und Oberlichtern  
Porte à deux vantaux avec deux parties latérales et impostes  
Double leaf door with two side lights and top lights

**Typenübersicht**  
**Sommaire des types**  
**Summary of types**

**Jansen-Economy 60 Türen**  
**Jansen-Economy 60 portes**  
**Jansen-Economy 60 doors**

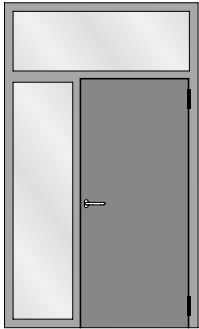

Verblechte Türe mit Seitenteil und Oberlicht  
Porte tôlée à un vantail avec avec partie latérale  
et imposte  
Sheet metal single leaf door with side light  
and top light



Verblechte zweiflügelige Türe mit zwei  
Seitenteilen und Oberlichtern  
Porte tôlée à deux vantaux avec deux parties  
latérales et impostes  
Sheet metal double leaf door with two side  
lights and top lights



Festverglasung  
Vitrage fixe  
Fixed glazing

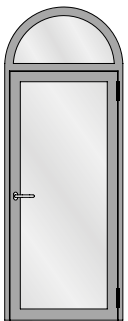

Einflügelige Türe mit Rundbogen-Oberlicht  
Porte à un vantail avec imposte demi-ronde  
Single leaf door with round arched top light

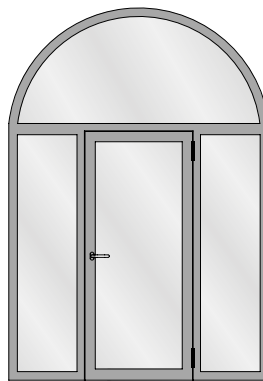

Einflügelige Türe mit zwei Seitenteilen und  
Rundbogen-Oberlicht  
Porte à un vantail avec deux parties latérales  
et imposte demi-ronde  
Single leaf door with two side lights and  
round arched top light

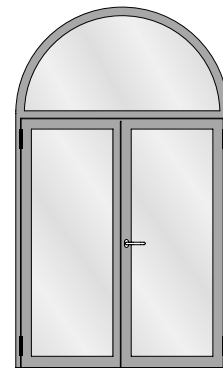

Zweiflügelige Türe mit Rundbogen-Oberlicht  
Porte à deux vantaux avec imposte demi-ronde  
Double leaf door with round arched top light

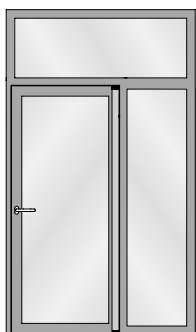

Fingerschutztüre  
Porte anti-pince-doigts  
Anti-finger-trap door

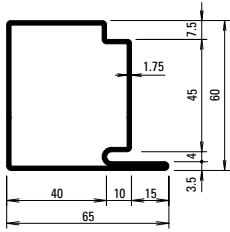

**30.019**  
**30.019 Z**

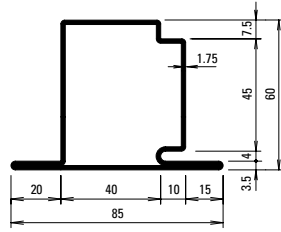

**30.119**  
**30.119 Z**

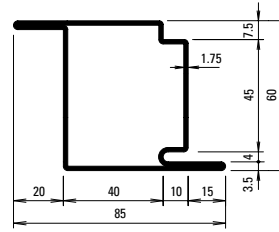

**30.419**  
**30.419 Z**

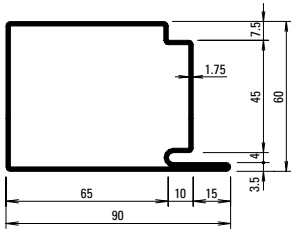

**30.017**  
**30.017 Z**

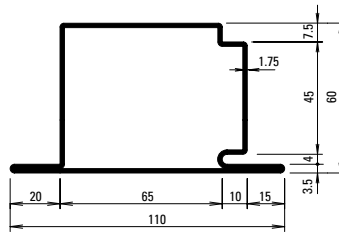

**30.117**  
**30.117 Z**

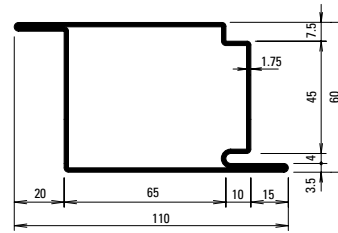

**30.415**

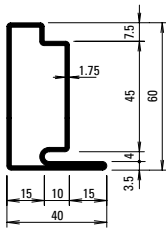

**30.018**  
**30.018 Z**

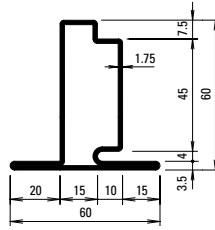

**30.118**  
**30.118 Z**

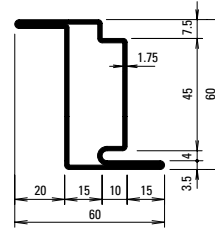

**30.418**  
**30.418 Z**

**Oberfläche/Werkstoff**

Artikel-Nr.

**ohne Zusatz** = blank

**mit Z** = bandverzinkter Stahl

**Surface/Matériau**

No. d'article

**sans supplément** = brut

**avec Z** = bande d'acier zinguée

**Surface/Material**

Part no.

**without addition** = bright

**with Z** = strip galvanised steel

Profil-Nr.	G kg/m	F cm <sup>2</sup>	I <sub>x</sub> cm <sup>4</sup>	W <sub>x</sub> cm <sup>3</sup>	I <sub>y</sub> cm <sup>4</sup>	W <sub>y</sub> cm <sup>3</sup>	U m <sup>2</sup> /m
<b>30.017</b>	4,200	5,36	31,32	9,09	48,57	10,35	0,312
<b>30.018</b>	2,830	3,61	15,95	4,35	4,77	1,93	0,212
<b>30.019</b>	3,520	4,48	23,69	6,70	19,75	5,55	0,262
<b>30.117</b>	4,750	6,04	34,75	9,35	65,74	11,51	0,350
<b>30.118</b>	3,370	4,29	18,64	4,65	8,26	2,75	0,250
<b>30.119</b>	4,050	5,16	26,80	6,99	29,12	6,58	0,300

Profil-Nr.	G kg/m	F cm <sup>2</sup>	I <sub>x</sub> cm <sup>4</sup>	W <sub>x</sub> cm <sup>3</sup>	I <sub>y</sub> cm <sup>4</sup>	W <sub>y</sub> cm <sup>3</sup>	U m <sup>2</sup> /m
<b>30.415</b>	4,750	6,04	37,79	12,28	65,74	11,51	0,350
<b>30.418</b>	3,370	4,29	22,92	7,37	8,62	2,75	0,250
<b>30.419</b>	4,050	5,16	30,36	9,82	29,12	6,58	0,300



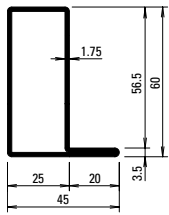

**01.634**  
**01.634 Z**

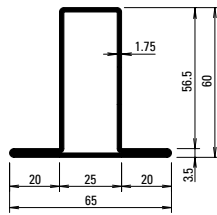

**02.634**  
**02.634 Z**

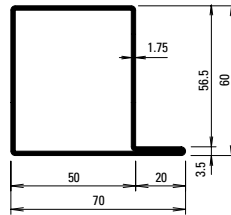

**01.684**  
**01.684 Z**

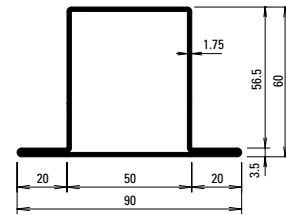

**02.684**  
**02.684 Z**

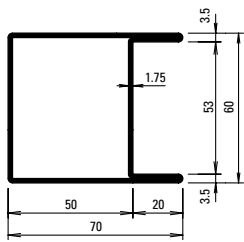

**04.637**  
**04.637 Z**

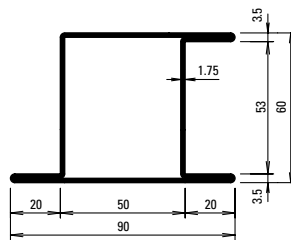

**05.637**  
**05.637 Z**

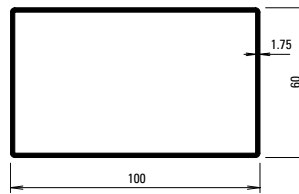

**400.051**  
**400.051 Z**

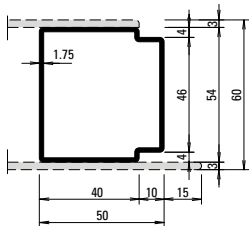

**81.010 Z**

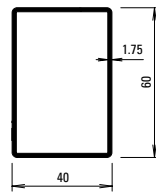

**400.052**  
**400.052 Z**

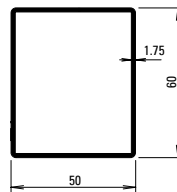

**400.054**  
**400.054 Z**

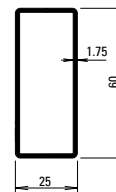

**400.055**  
**400.055 Z**

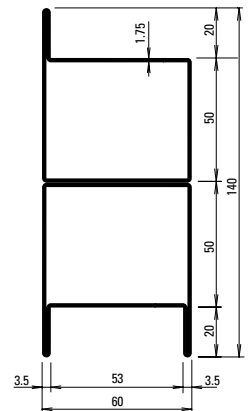

**05.001**

Profil-Nr.	G kg/m	F cm <sup>2</sup>	I <sub>x</sub> cm <sup>4</sup>	W <sub>x</sub> cm <sup>3</sup>	I <sub>y</sub> cm <sup>4</sup>	W <sub>y</sub> cm <sup>3</sup>	U m <sup>2</sup> /m
<b>01.634</b>	2,730	3,48	16,71	4,71	6,04	2,15	0,204
<b>02.634</b>	3,270	4,17	19,66	5,01	10,34	3,18	0,243
<b>01.684</b>	3,430	4,37	24,34	7,07	22,12	5,59	0,255
<b>02.684</b>	3,960	5,05	27,70	7,36	31,93	7,09	0,294
<b>04.637</b>	3,960	5,05	30,62	10,2	27,45	7,71	0,294
<b>05.637</b>	4,500	5,72	35,42	10,6	39,45	8,02	0,333
<b>81.010</b>	2,700	3,43	14,53	5,38	13,05	5,10	0,202
<b>400.051</b>	4,300	5,44	76,01	15,2	34,64	11,55	0,316
<b>400.052</b>	2,630	3,34	8,98	4,49	16,86	5,62	0,197
<b>400.054</b>	2,900	3,69	14,97	5,98	19,83	6,61	0,217
<b>400.055</b>	2,210	2,82	3,08	2,47	12,41	4,13	0,167

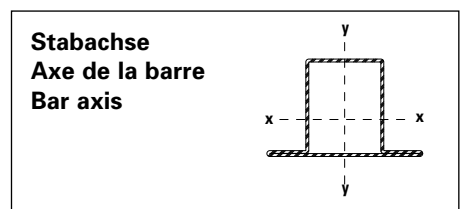

Artikelbibliothek  
 Bibliothèque des articles  
 Article library

**DXF** **DWG**

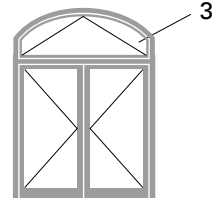
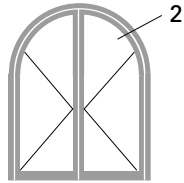
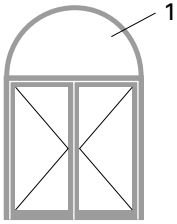

**1.0**

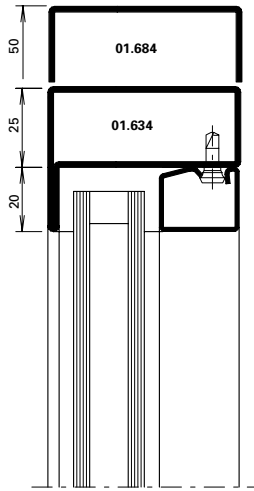

**2.0**

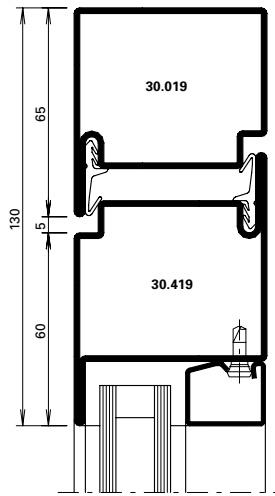

**3.0**

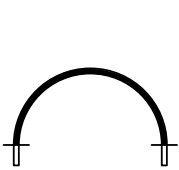
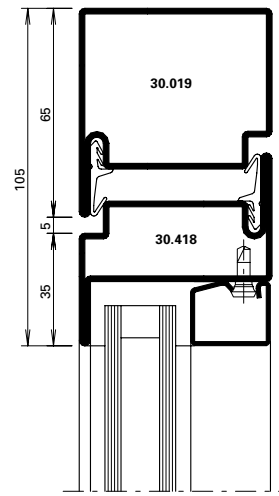

Halbrundbogen  
 Arc semi-circulaire  
 Semi-circular arch

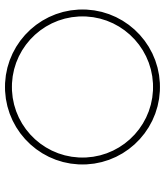

Rundbogen  
 Arc en plein centre  
 Round arch

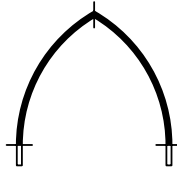

Spitzbogen  
 Ogive  
 Gothic arch



Stichbogen  
 Arc bombé  
 Segmented arch



Korbbogen  
 Anse de panier  
 Oval arch

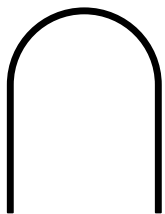

Halbrundbogen mit Schenkel  
 Arc surhaussé  
 Semi-circular arch with side extension

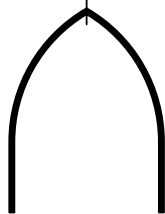

Spitzbogen mit Schenkel  
 Arc en ogive  
 Gothic arch with side extension

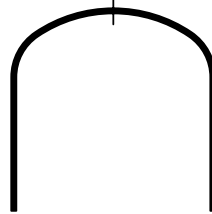



Korbbogen mit Schenkel  
 Anse de panier prolongée  
 Oval arch with side extension

**Bogentüren**  
**Portes cintrées**  
**Arched doors**

Jansen-Economy 60 Türen  
 Jansen-Economy 60 portes  
 Jansen-Economy 60 doors

Profil Profilé Profile	Min. Radius Rayon min. Min. radius R	
------------------------------	---	--

	blank brut bright	verzinkt zinguée galvanised
	mm	mm
01.634	550	550
01.684	650	650

		
02.634	600	650
02.684	1050	1050

		
04.637	1550	1550

		
05.637	1550	1550

		
400.052	1100	1100
400.054	1000	1000
400.055	800	800
81.010		800

Profil Profilé Profile	Min. Radius Rayon min. Min. radius R	
------------------------------	---	--

	blank brut bright	verzinkt zinguée galvanised
	mm	mm
30.018		550
30.019	650	650

		
30.118	800	800
30.119	900	900

		
30.418	800	800
30.419	1100	1100

Stahl-Glasleisten Parcloses en acier Steel glazing beads	Min. Radius Rayon min. Min. radius R
--	---

	
62.507 Z	300 mm
62.508 Z	300 mm
62.509 Z	300 mm

Stahl-Glasleisten Parcloses en acier Steel glazing beads	Min. Radius Rayon min. Min. radius R
--	---

	
402.112 Z	500 mm
402.115 Z	500 mm
402.120 Z	600 mm
402.125 Z	750 mm
402.130 Z	1000 mm
402.135 Z	1500 mm

Aluminium-Glasleisten Parcloses en aluminium Aluminium glazing beads	Min. Radius Rayon min. Min. radius R
--	---

	
404.109	400 mm
404.112	400 mm
404.115	400 mm
404.120	400 mm
404.125	450 mm
404.130	500 mm
404.135	600 mm

	
405.110	500 mm
405.115	500 mm
405.120	500 mm
405.125	800 mm
405.130	1000 mm
406.903	500 mm
406.905	500 mm
406.907	500 mm
406.909	600 mm

Die Radien-Angaben beziehen sich auf die langjährige Erfahrung und Fertigung im Hause Jansen.

Les rayons indiqués se fondent sur la longue expérience et la fabrication au sein de la maison Jansen.

The radii specifications are based on the many years of experience Jansen has in fabrication.

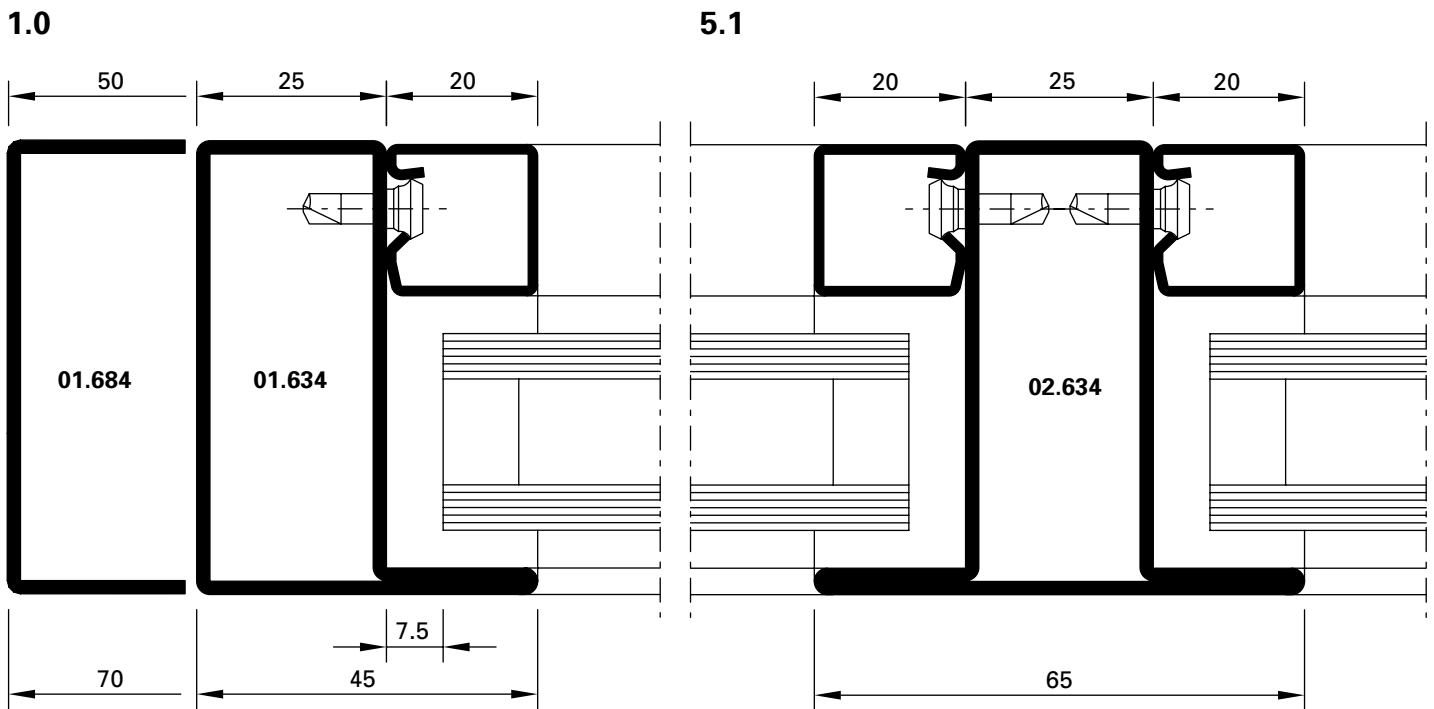
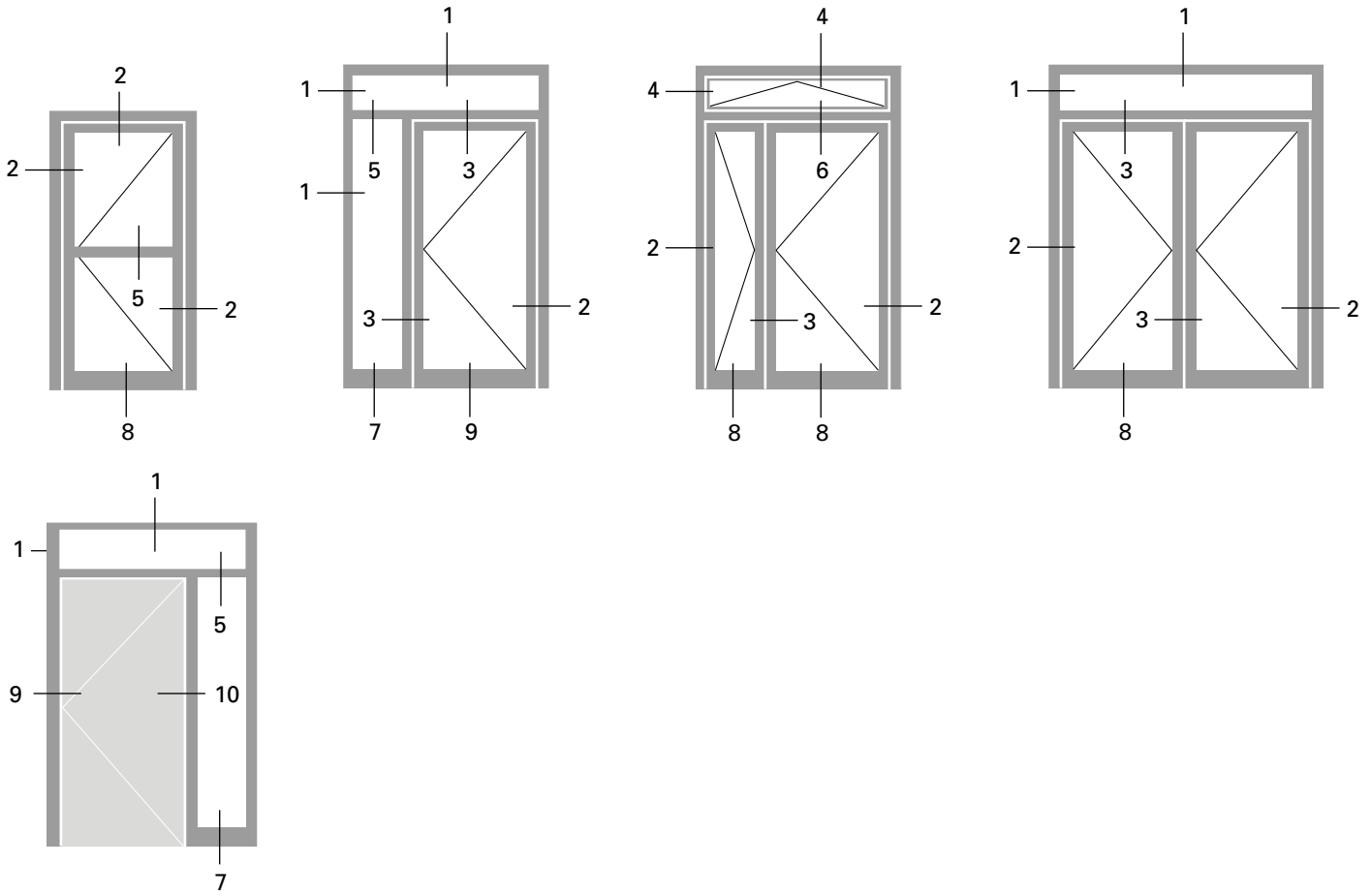

**DXF** **DWG** D-250-C-001

**DXF** **DWG** D-250-C-032

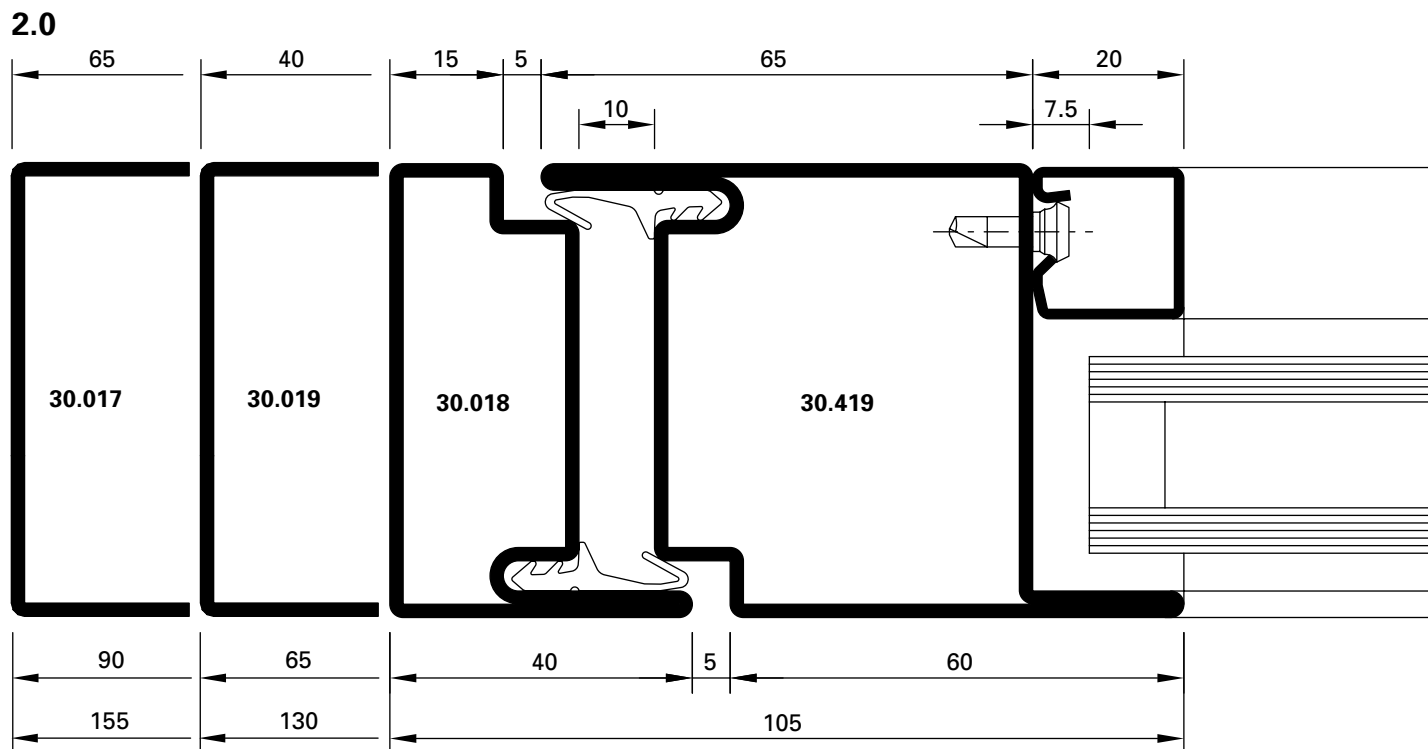

**DXF** **DWG** D-250-C-002

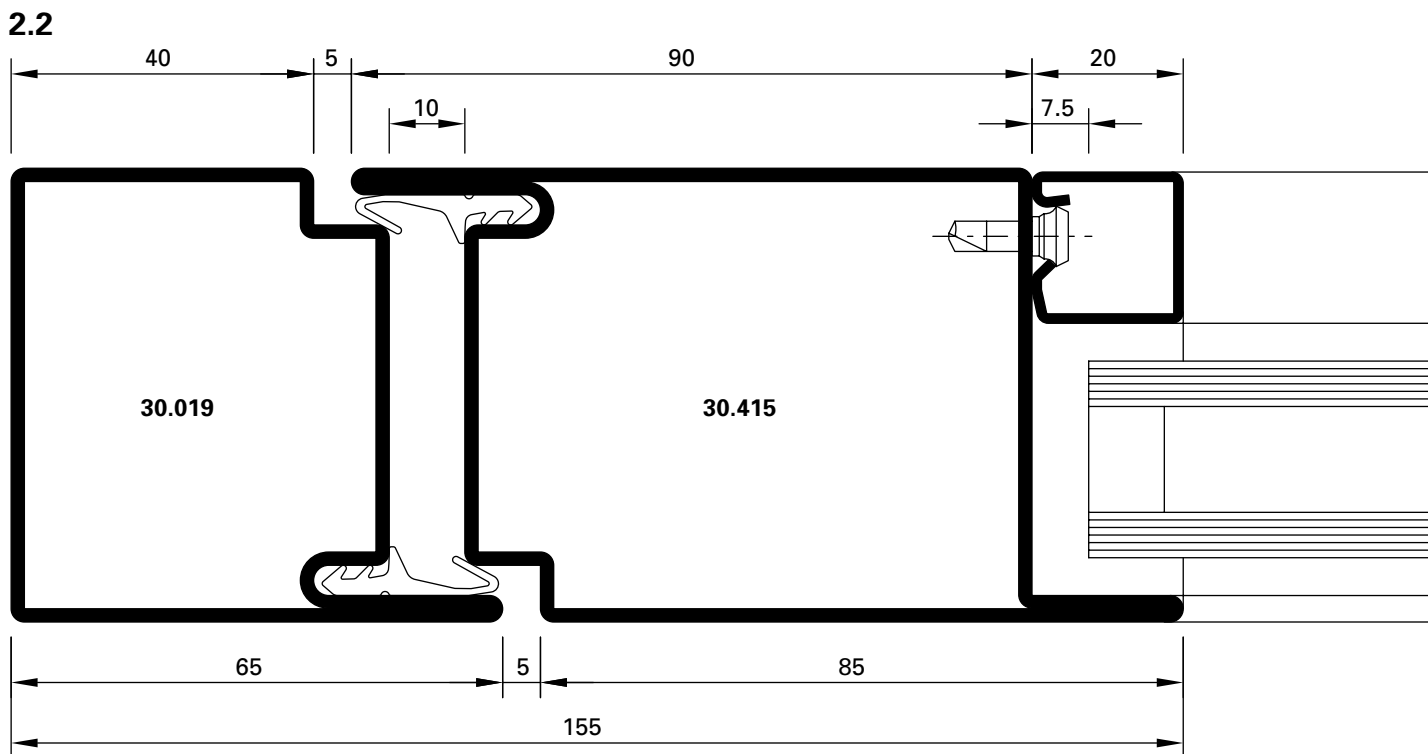

**DXF** **DWG** D-250-C-005

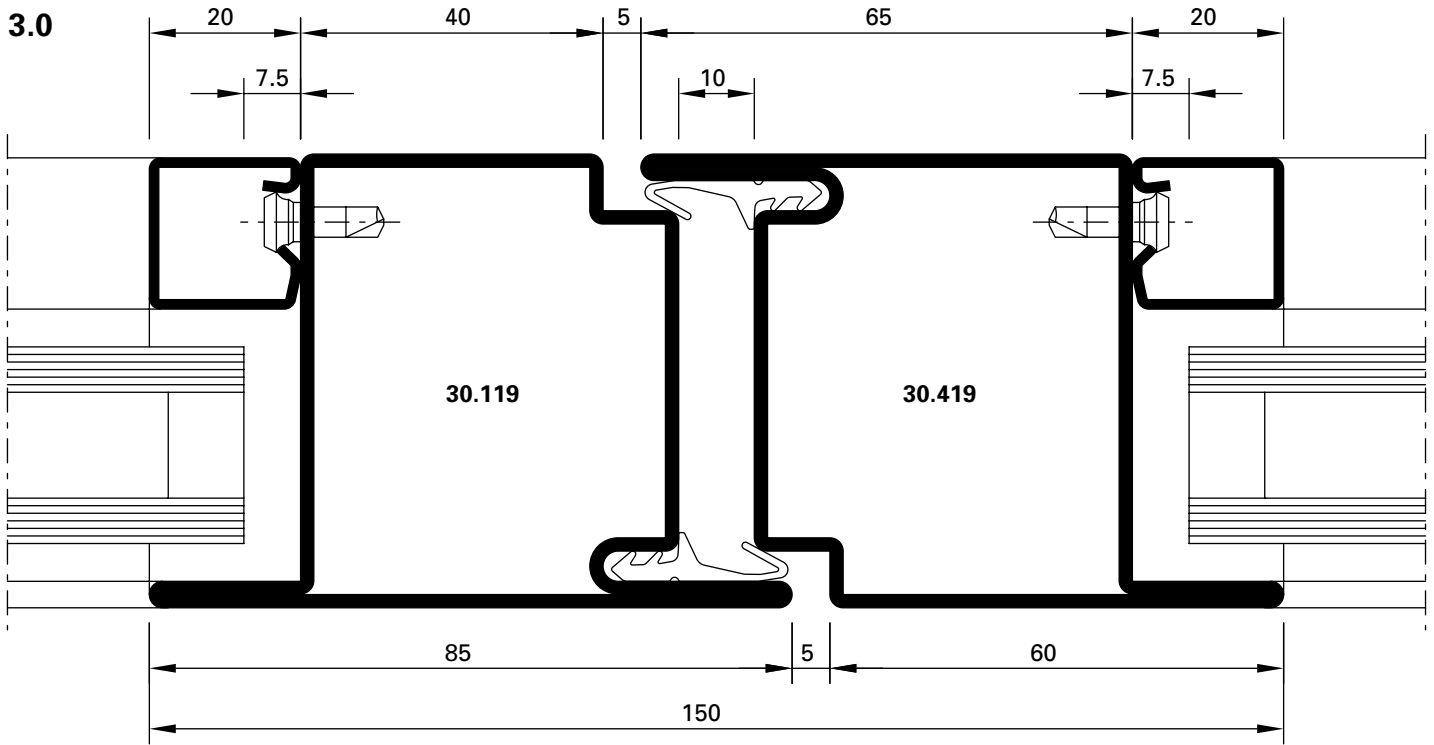

DXF DWG D-250-C-003

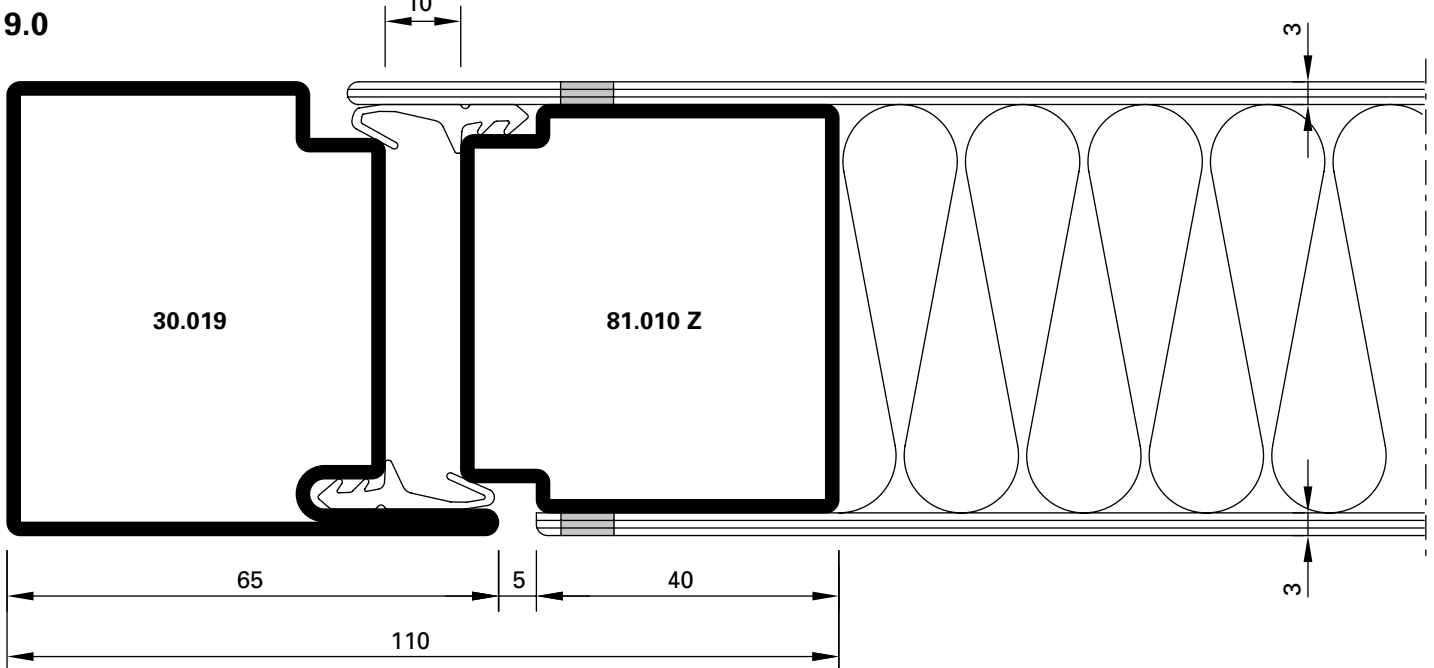

DXF DWG D-250-C-013

4.0

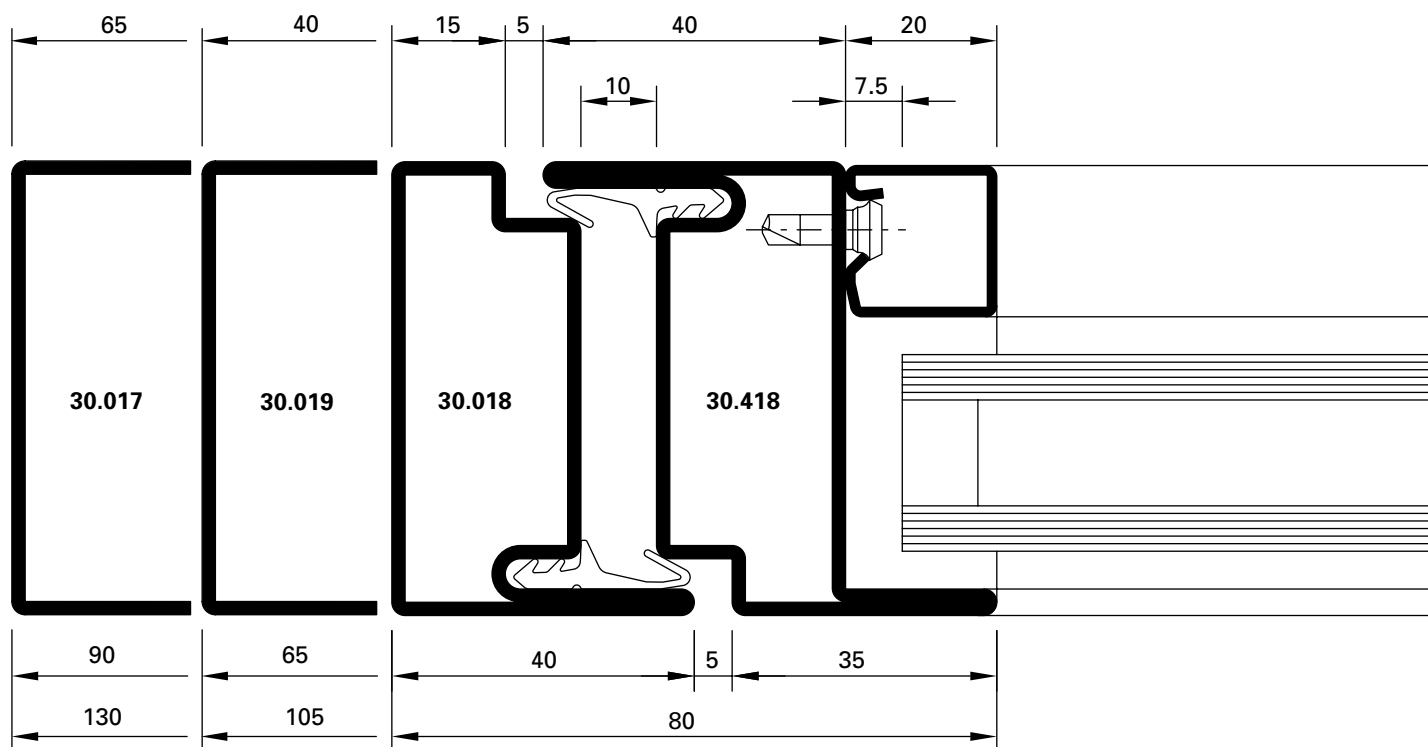

**DXF** **DWG** D-250-C-010

5.0

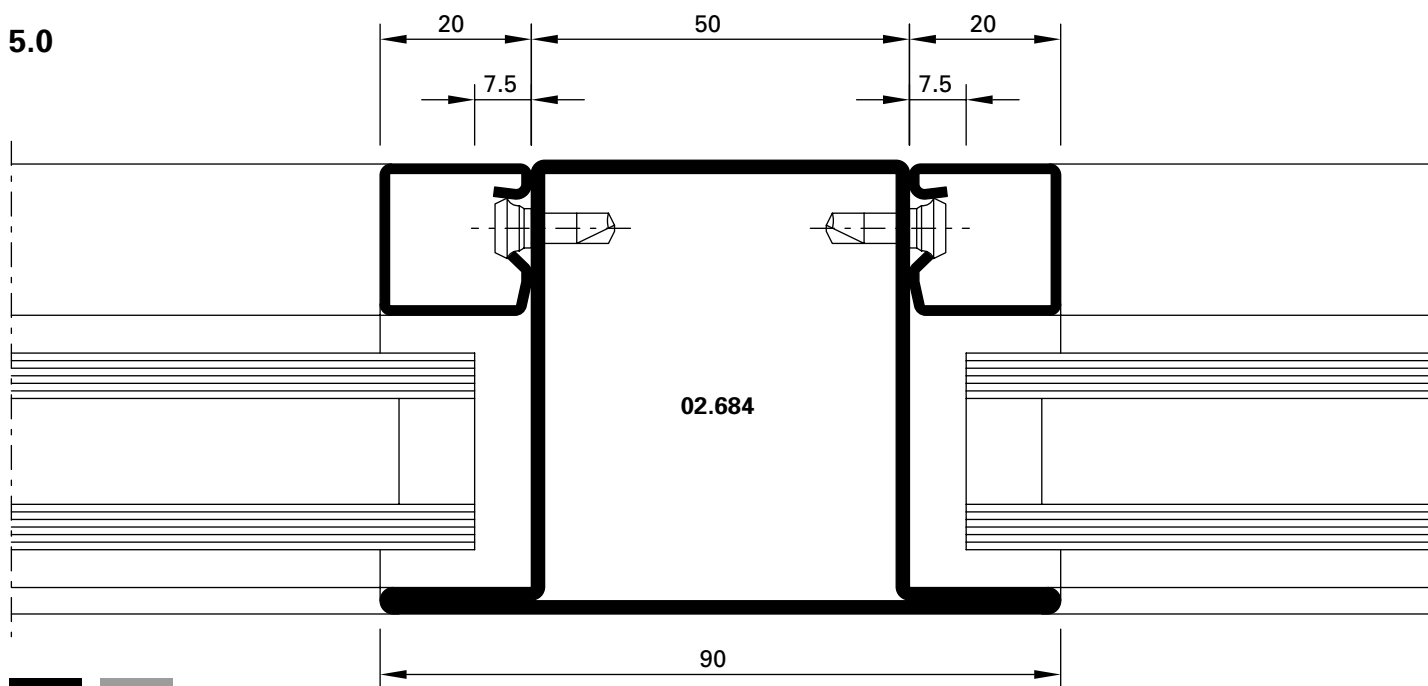

**DXF** **DWG** D-250-C-012

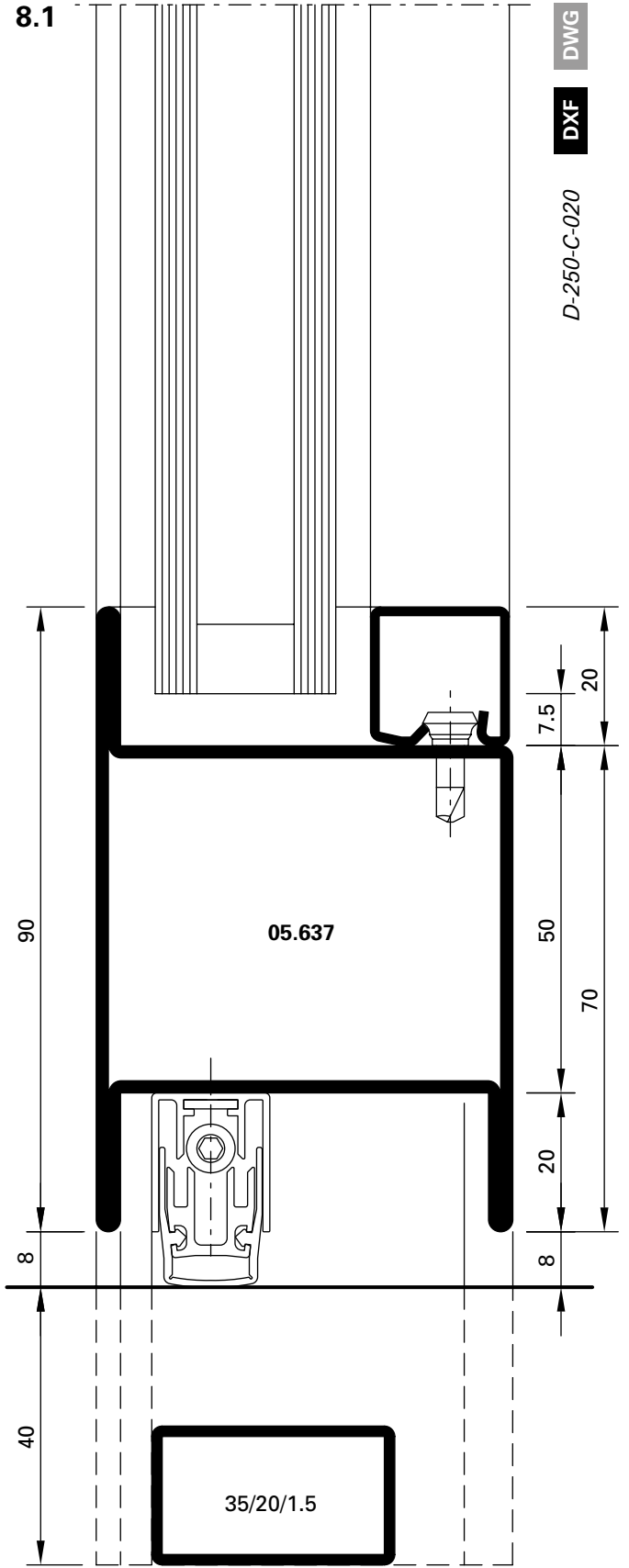
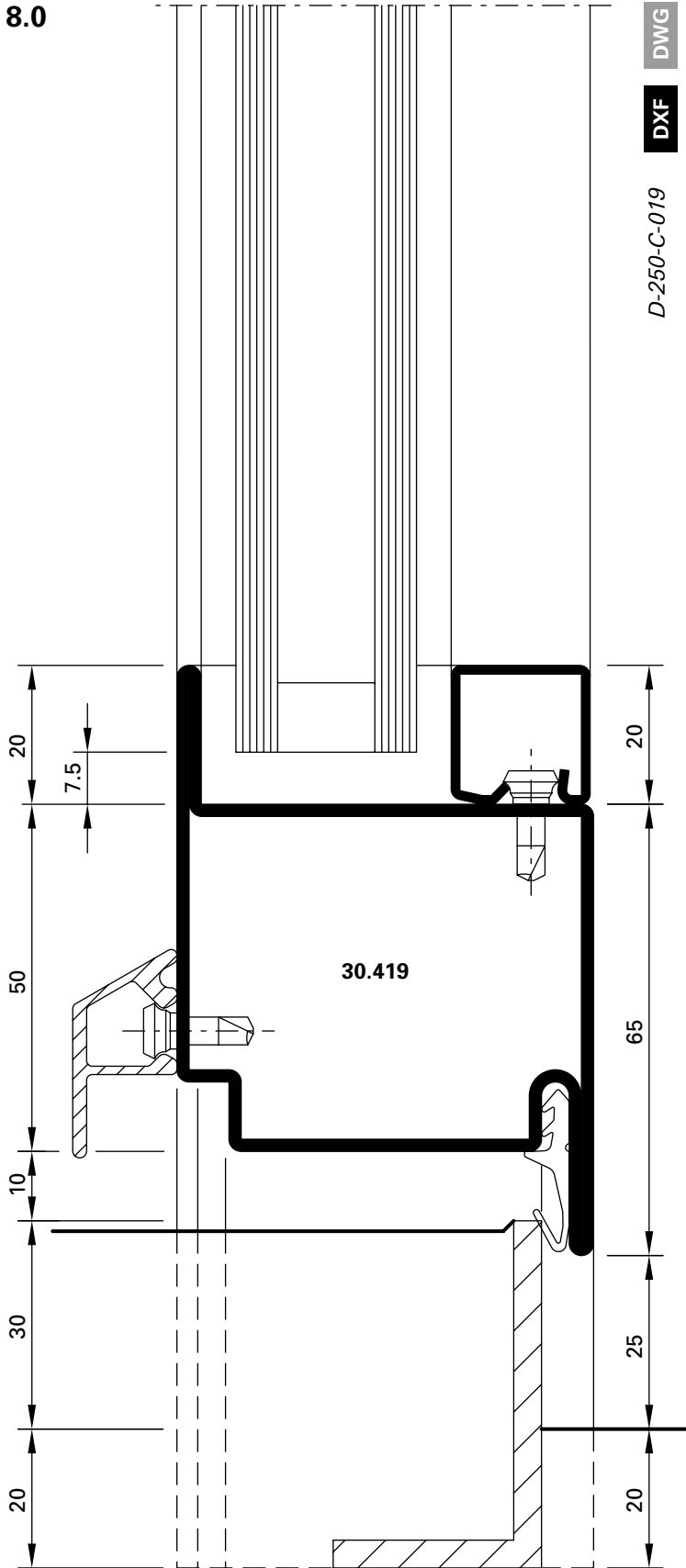



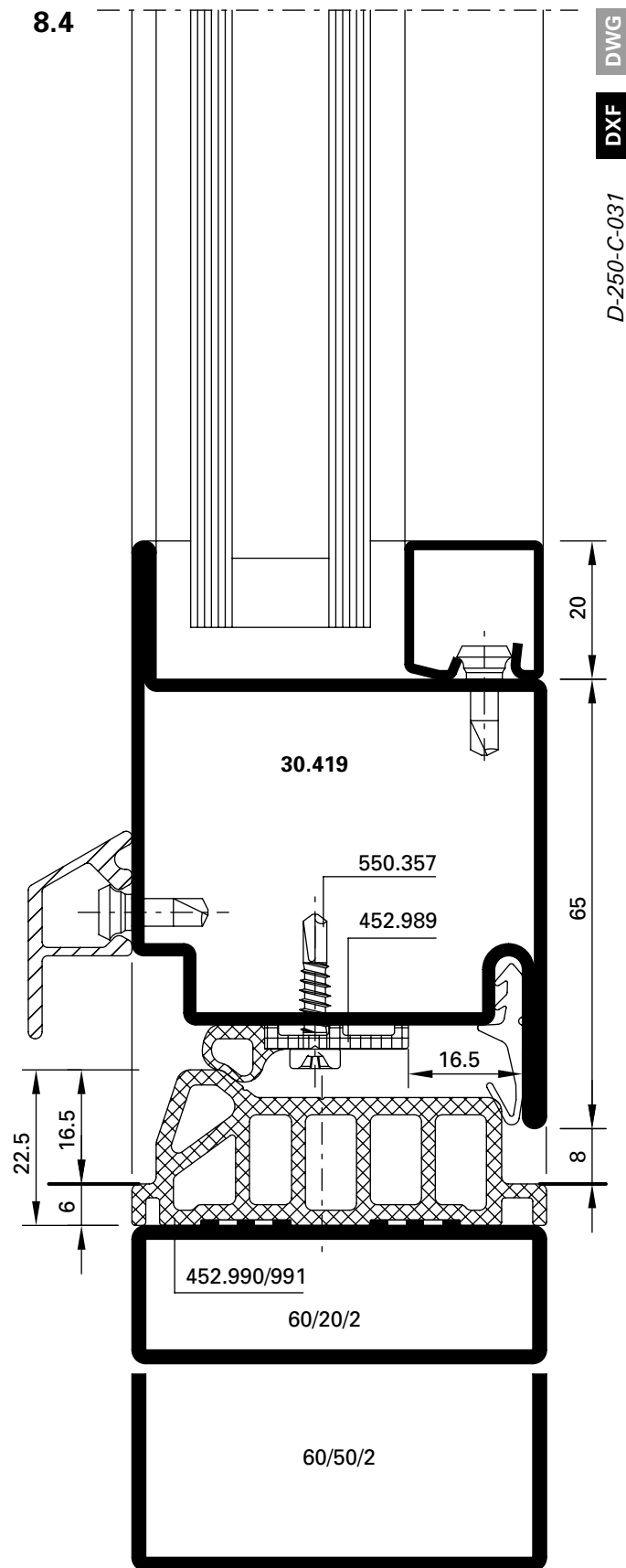
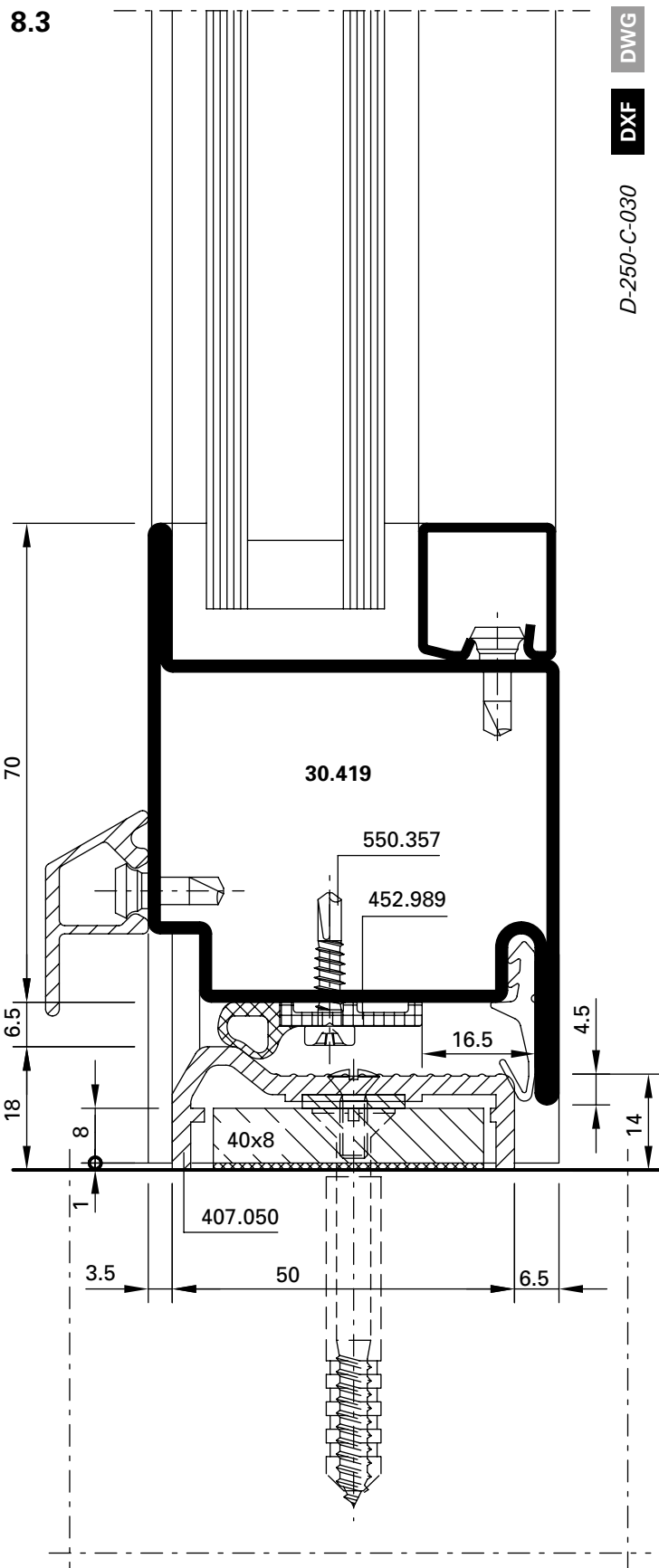

2.1

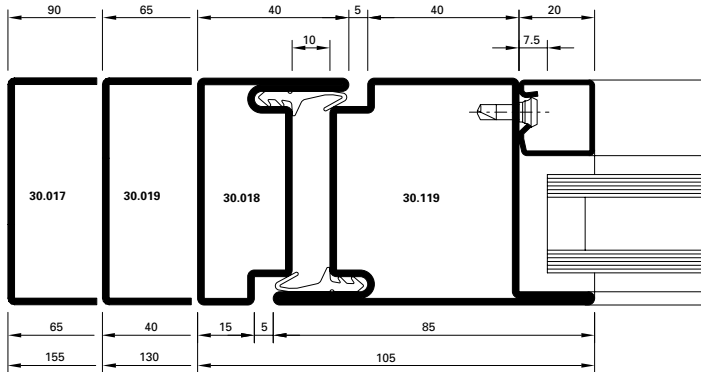

**DXF** **DWG** *D-250-C-004*

2.3

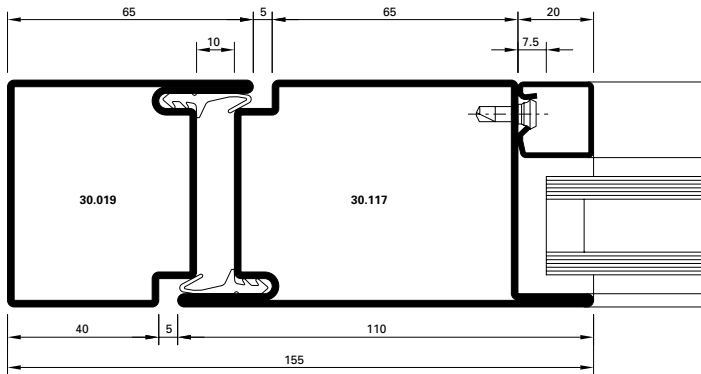

**DXF** **DWG** *D-250-C-006*

3.1

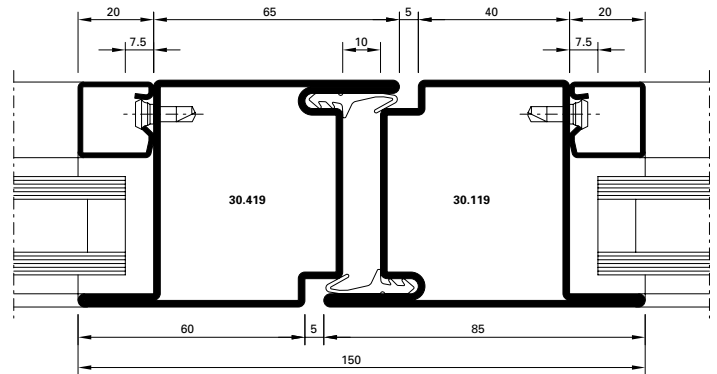

**DXF** **DWG** *D-250-C-007*

3.2

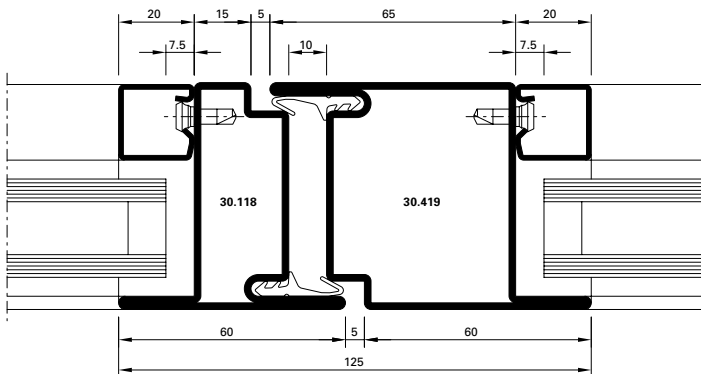

**DXF** **DWG** *D-250-C-008*

3.3

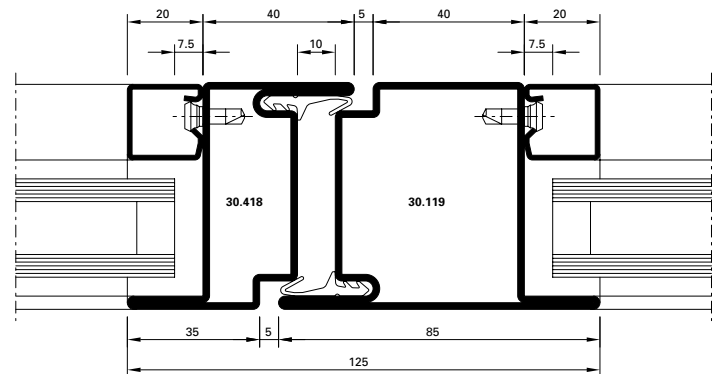

**DXF** **DWG** *D-250-C-009*

9.1

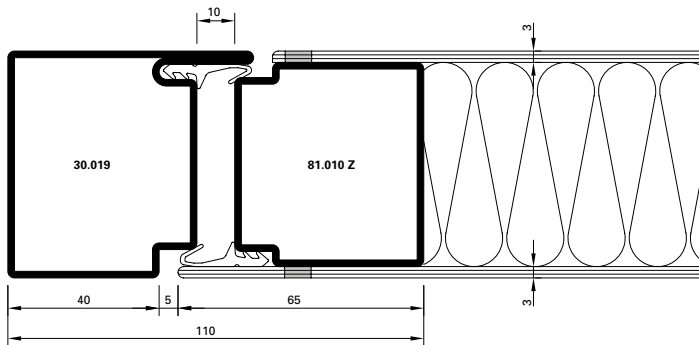

**DXF** **DWG** D-250-C-014

10.0

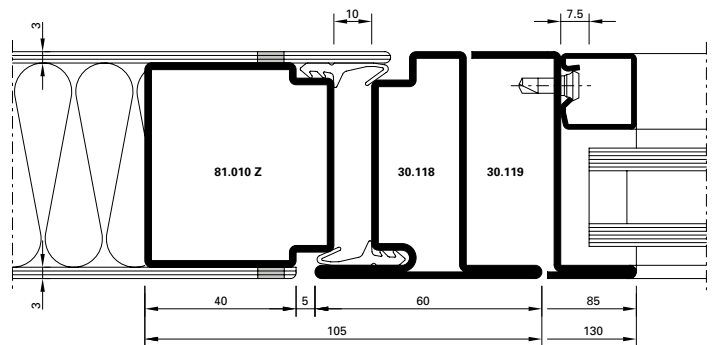

**DXF** **DWG** D-250-C-015

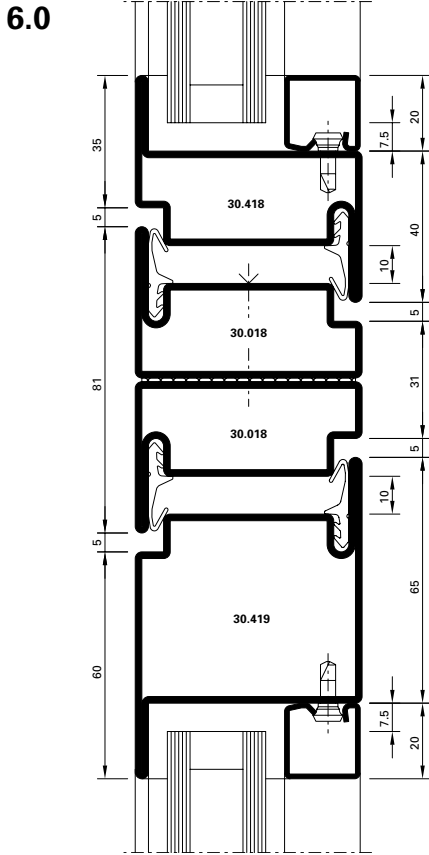

DWG  
 DXF  
 D-250-C-016

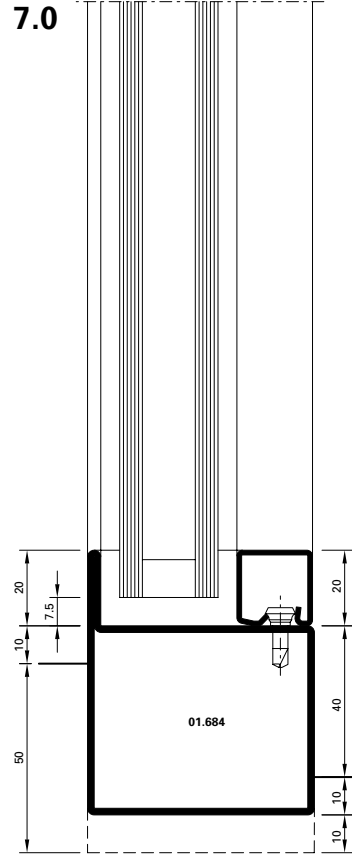

DWG  
 DXF  
 D-250-C-017

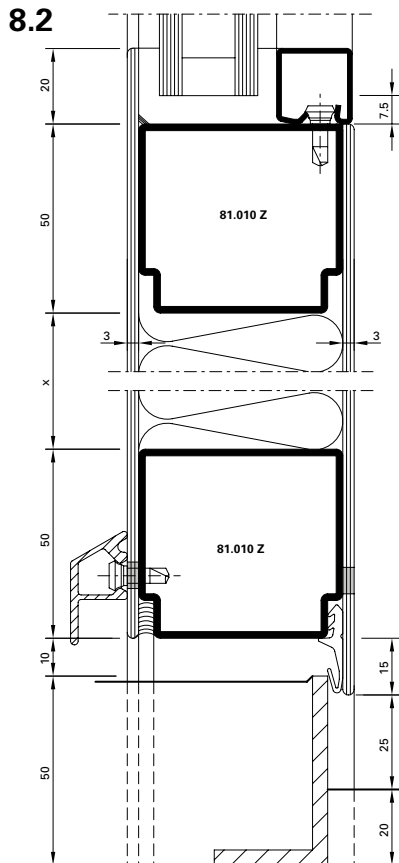

DWG  
 DXF  
 D-250-C-021

5.1

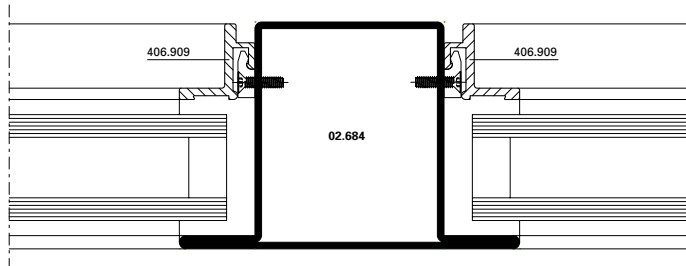

**DXF** **DWG** *D-250-C-022*

5.2

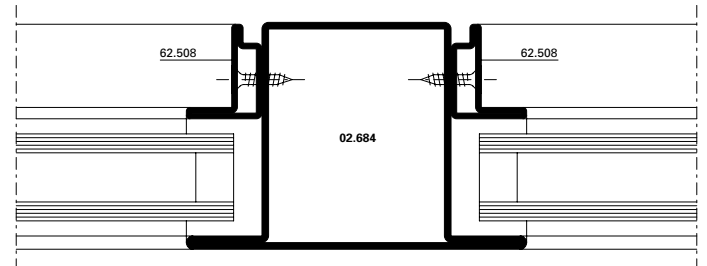

**DXF** **DWG** *D-250-C-023*

5.3

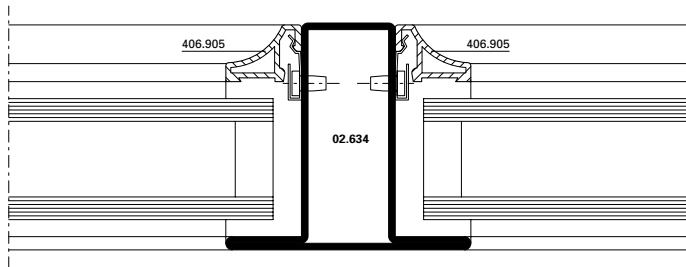

**DXF** **DWG** *D-250-C-024*

5.4

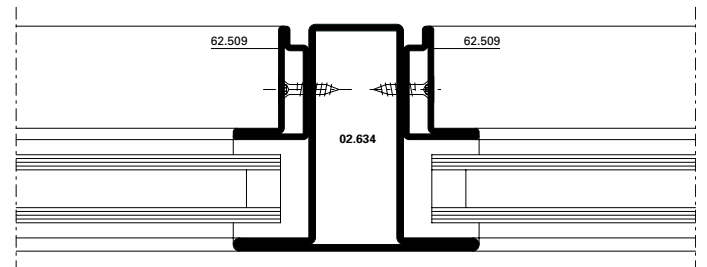

**DXF** **DWG** *D-250-C-025*

5.5

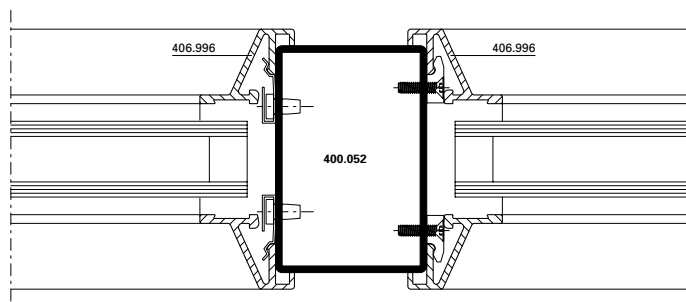

**DXF** **DWG** *D-250-C-026*

5.6

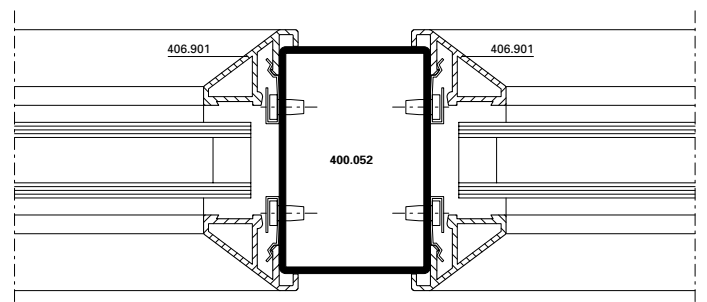

**DXF** **DWG** *D-250-C-027*

5.7

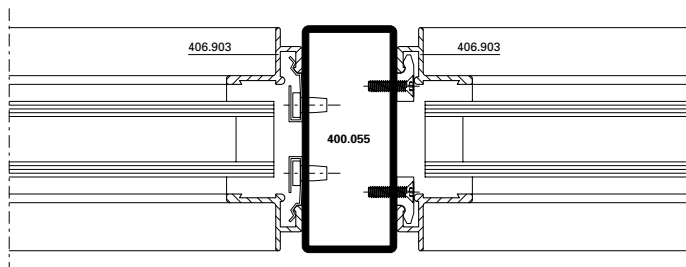

**DXF** **DWG** *D-250-C-028*

5.8

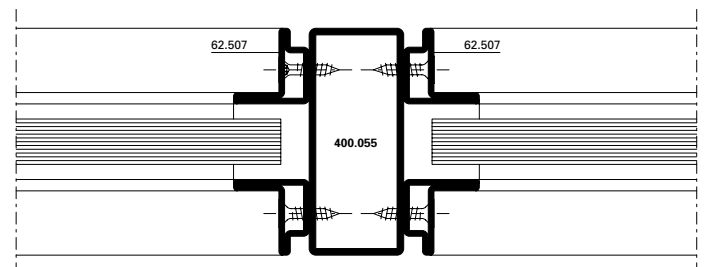

**DXF** **DWG** *D-250-C-029*

**Schnittpunkte im Massstab 1:1**  
**Coupe de détails à l'échelle 1:1**  
**Section details on scale 1:1**

**Jansen-Economy 60 Türen**  
**Jansen-Economy 60 portes**  
**Jansen-Economy 60 doors**

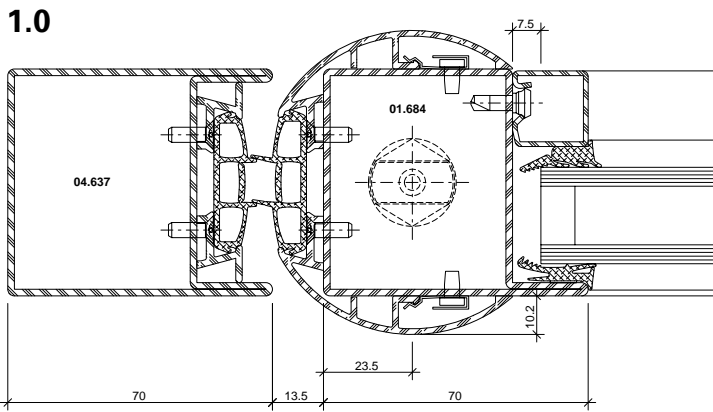
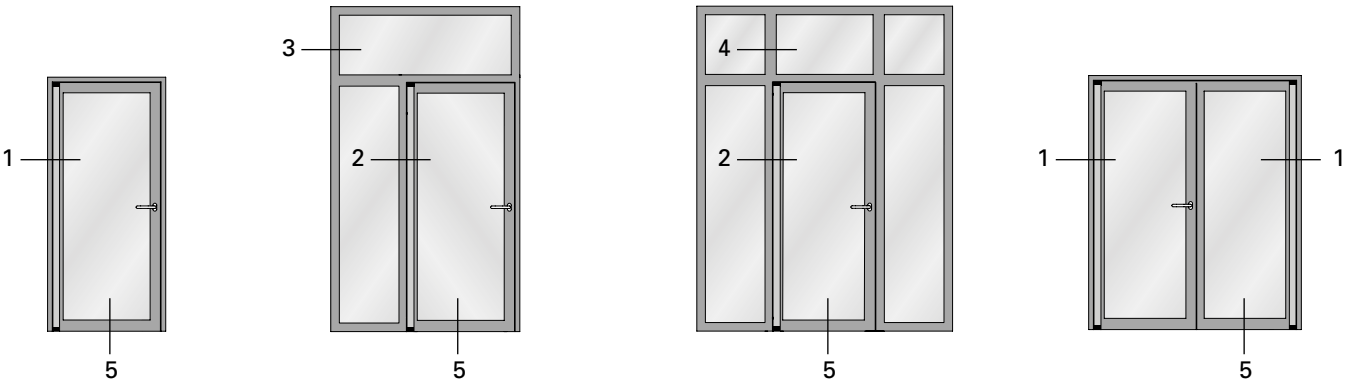

**DXF** **DWG** 22-0103-C-001

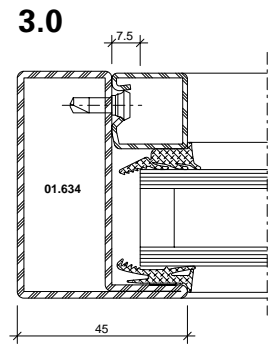

22-0101-C-001

**DXF** **DWG**

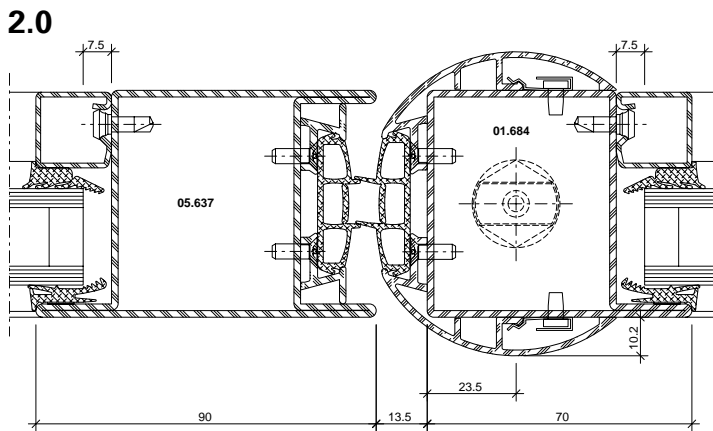

**DXF** **DWG** 22-0103-C-002

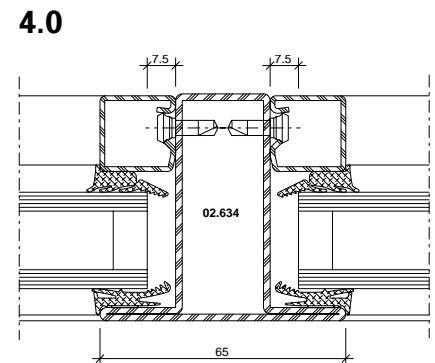

22-0101-C-002

**DXF** **DWG**

5.0

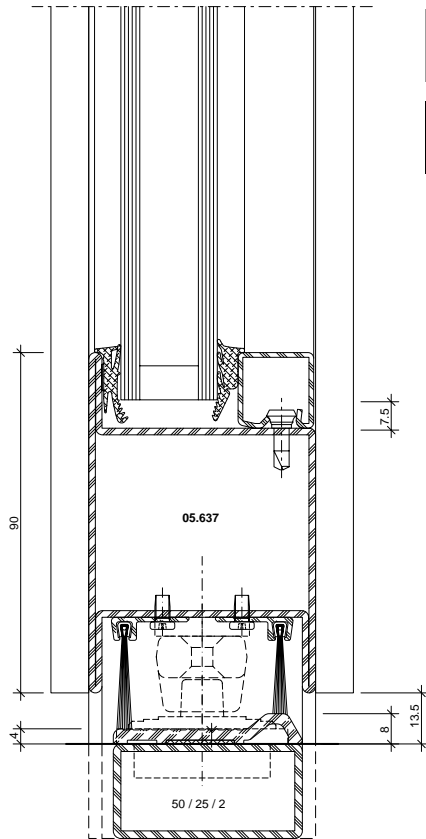

DWG

DXF

22-0103-C-003

5.1

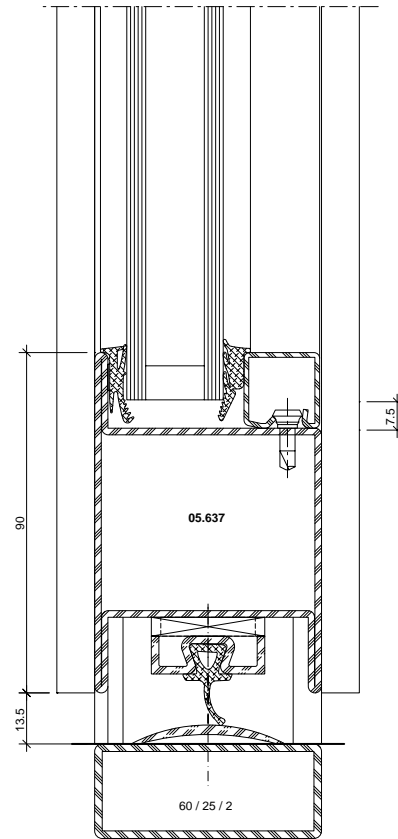

DWG

DXF

22-0103-C-009

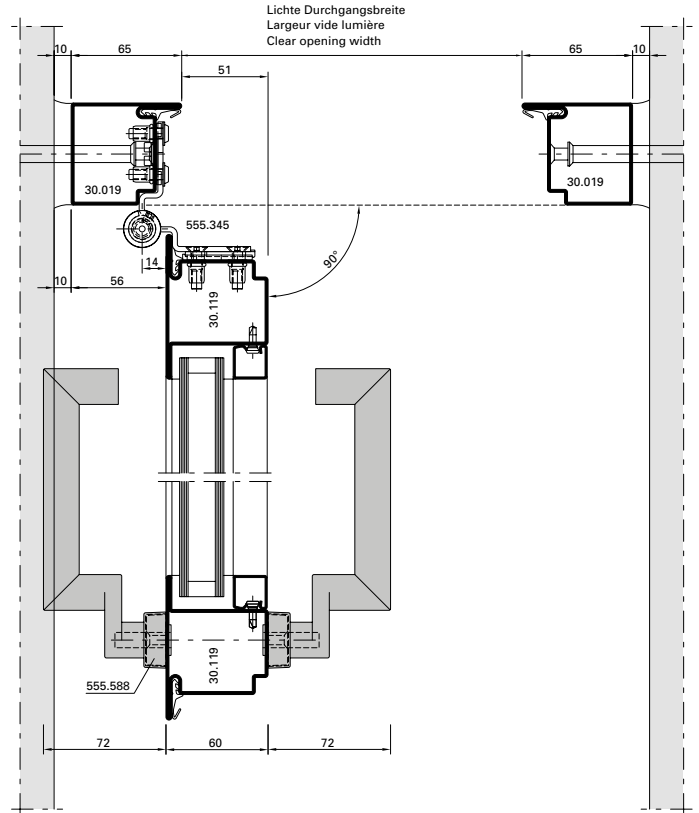
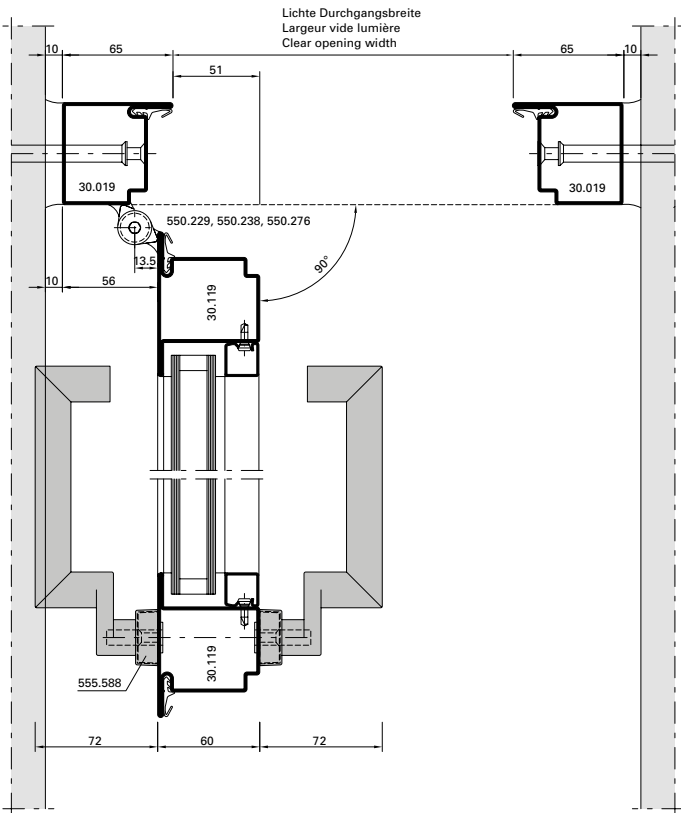

**DXF** **DWG** *D-250-E-016*

**DXF** **DWG** *D-250-E-018*

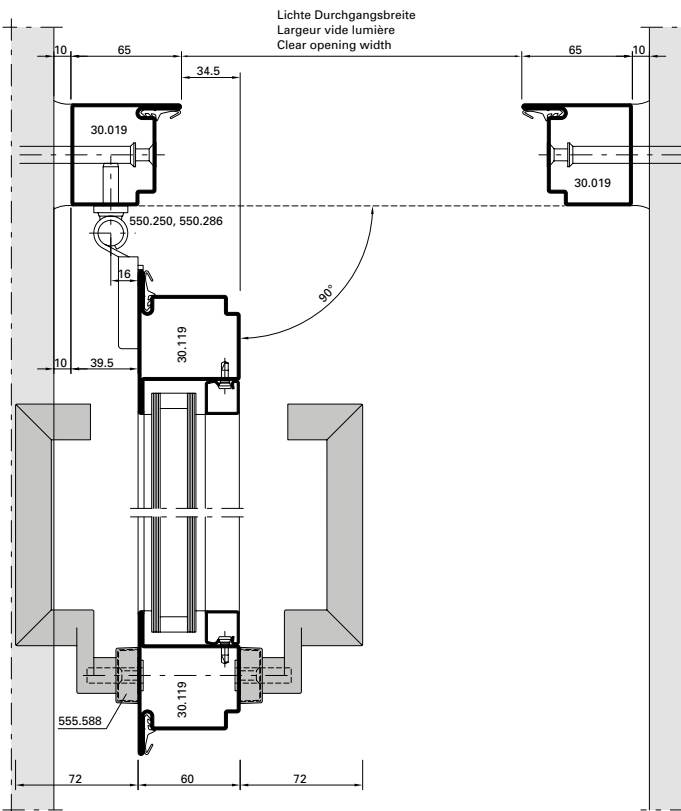

**DXF** **DWG** *D-250-E-020*



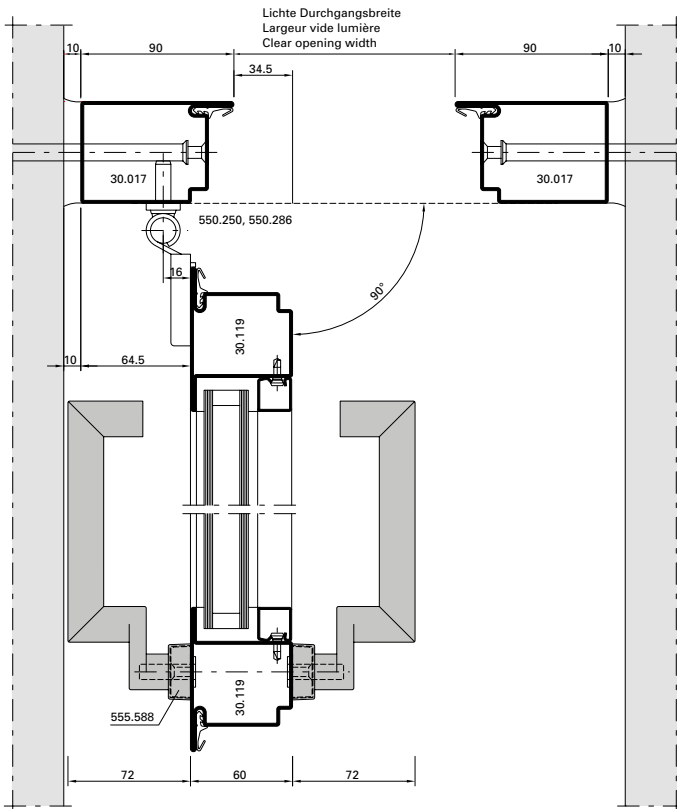

**DXF** **DWG** *D-250-E-021*

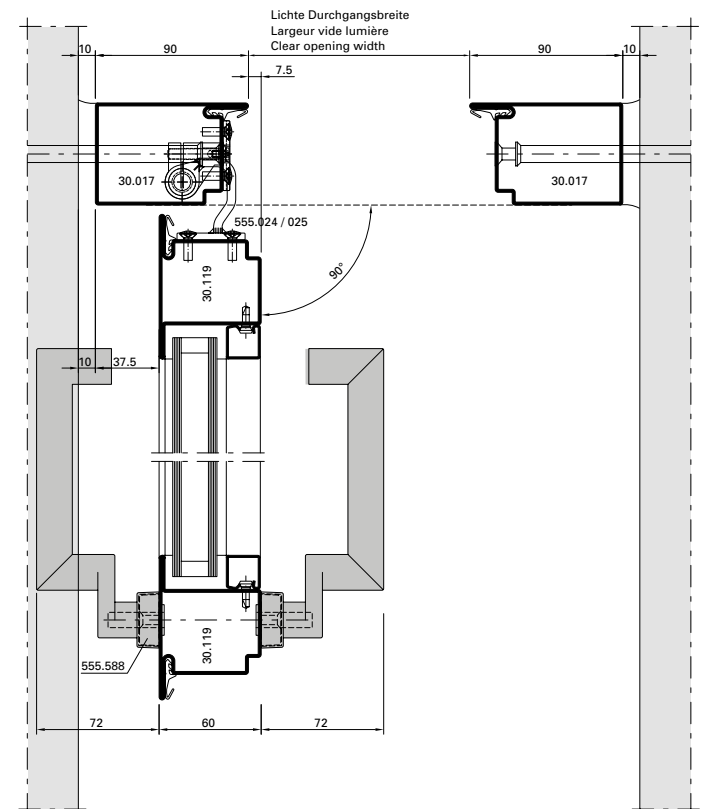

**DXF** **DWG** *D-250-E-025*

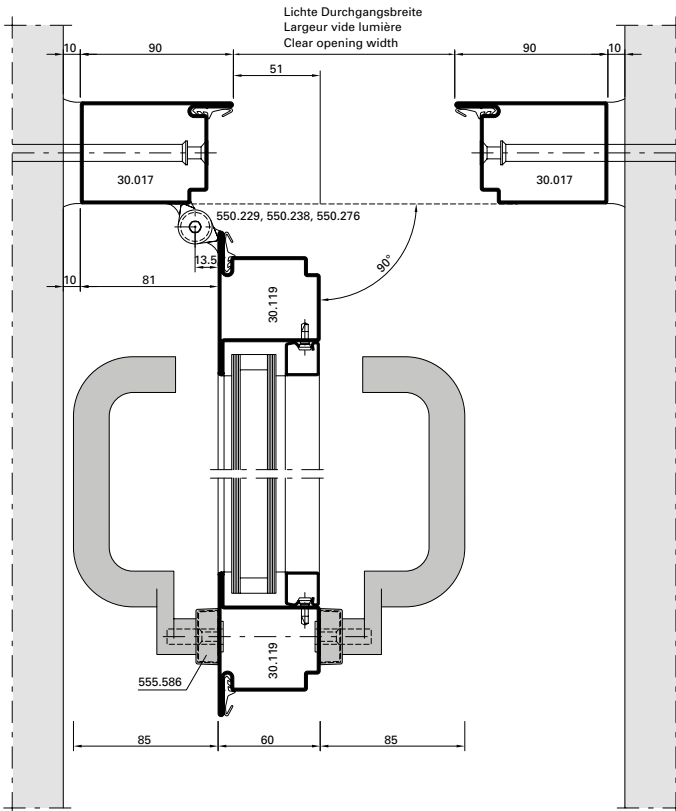

**DXF** **DWG** *D-250-E-017*

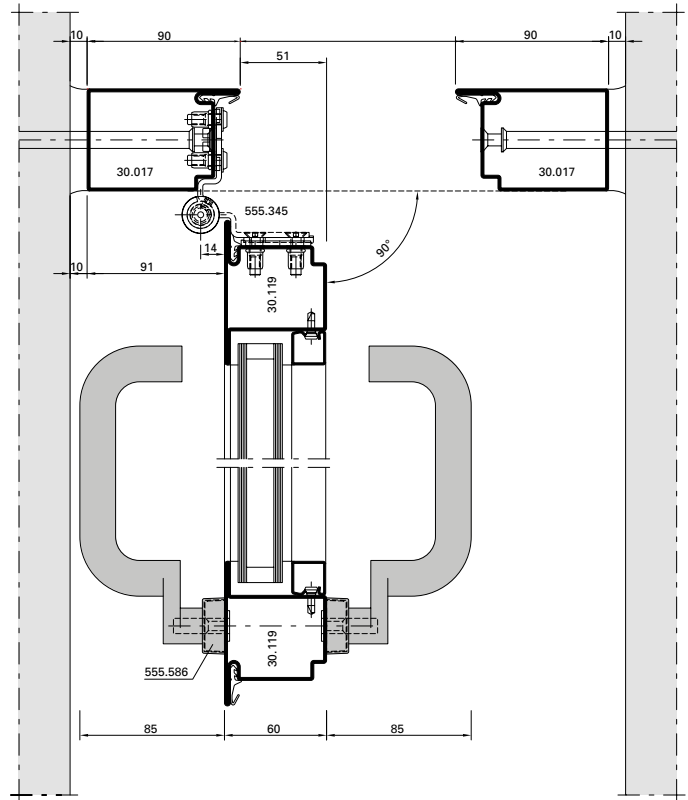

**DXF** **DWG** *D-250-E-019*

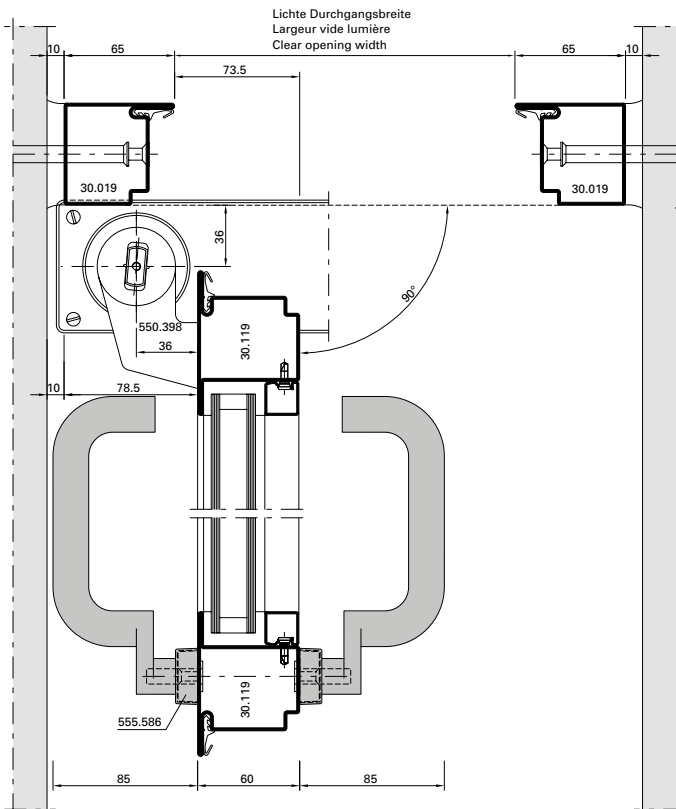

**DXF** **DWG** *D-250-E-022*

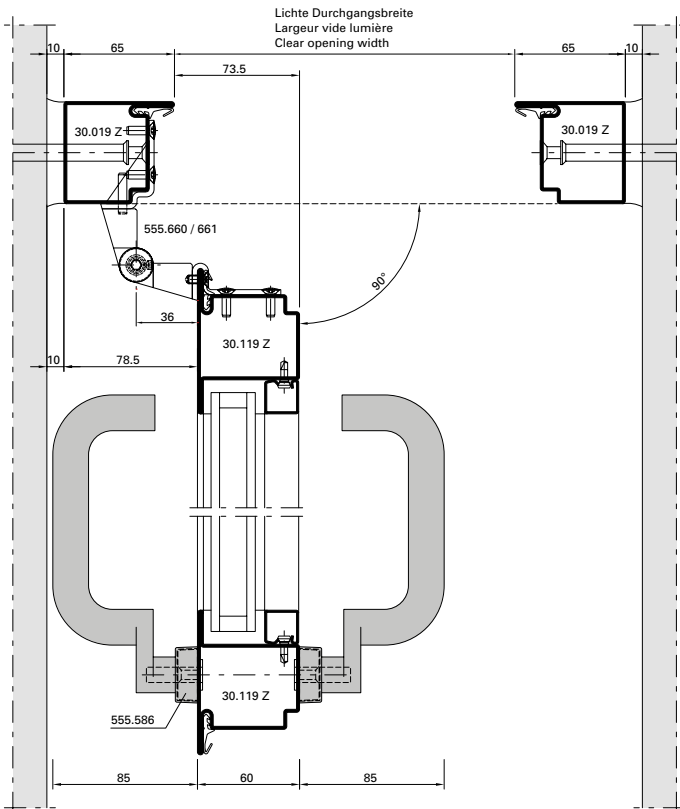

**DXF** **DWG** *D-250-E-023*

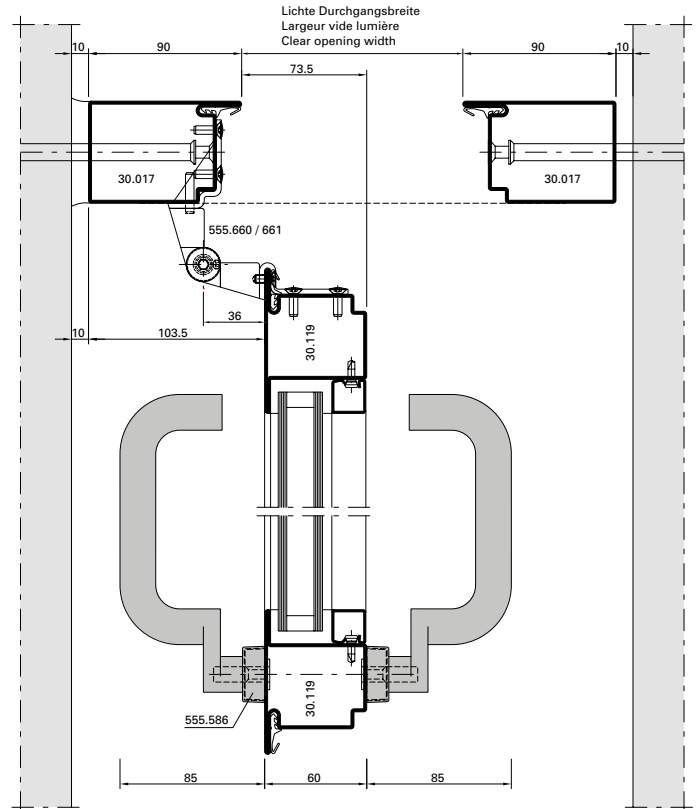

**DXF** **DWG** *D-250-E-024*

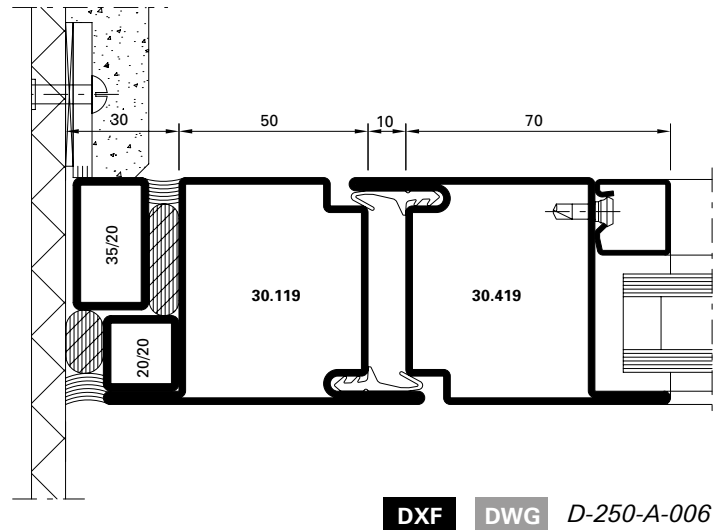
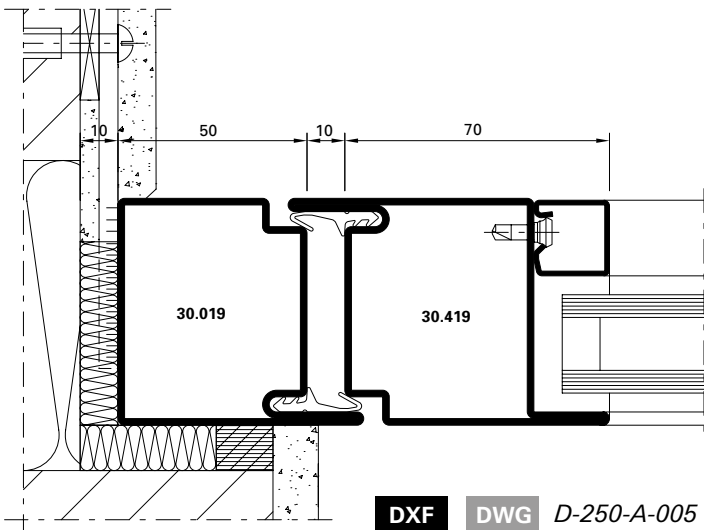
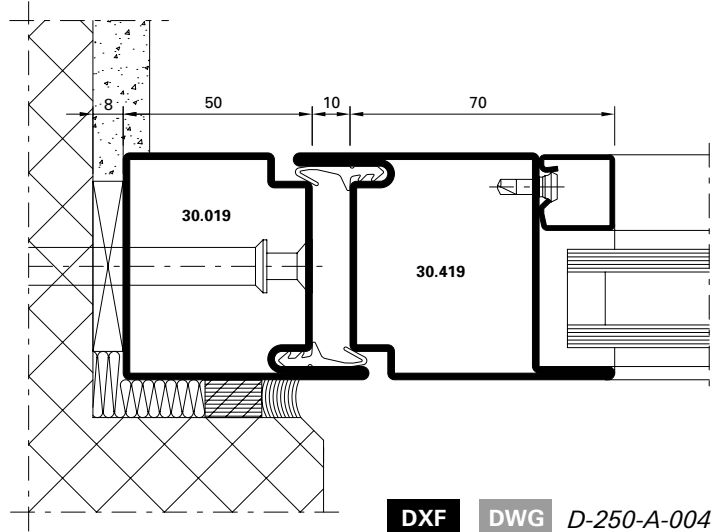
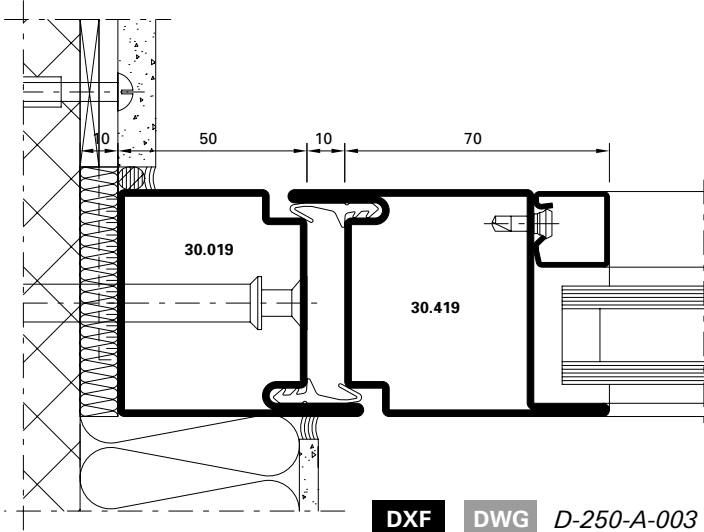
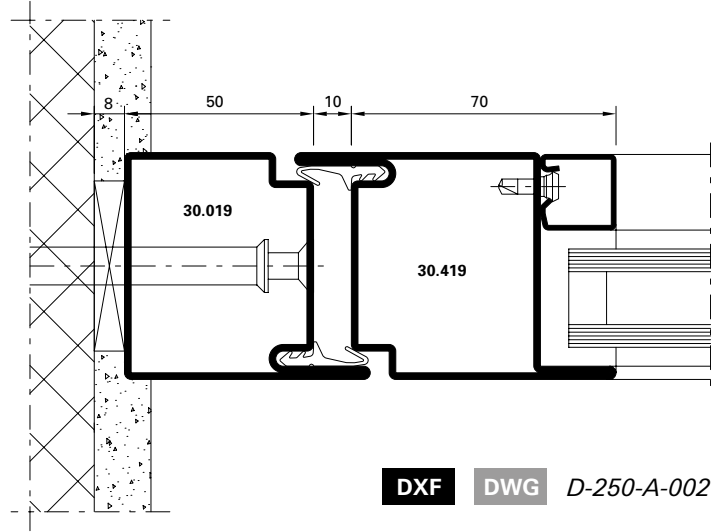
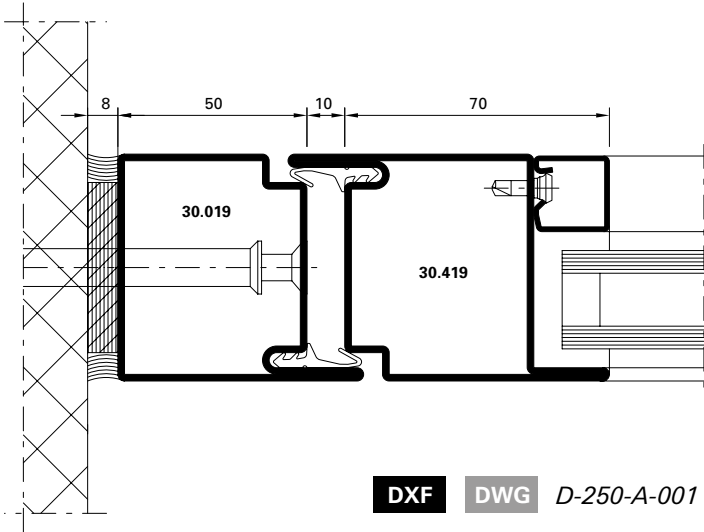

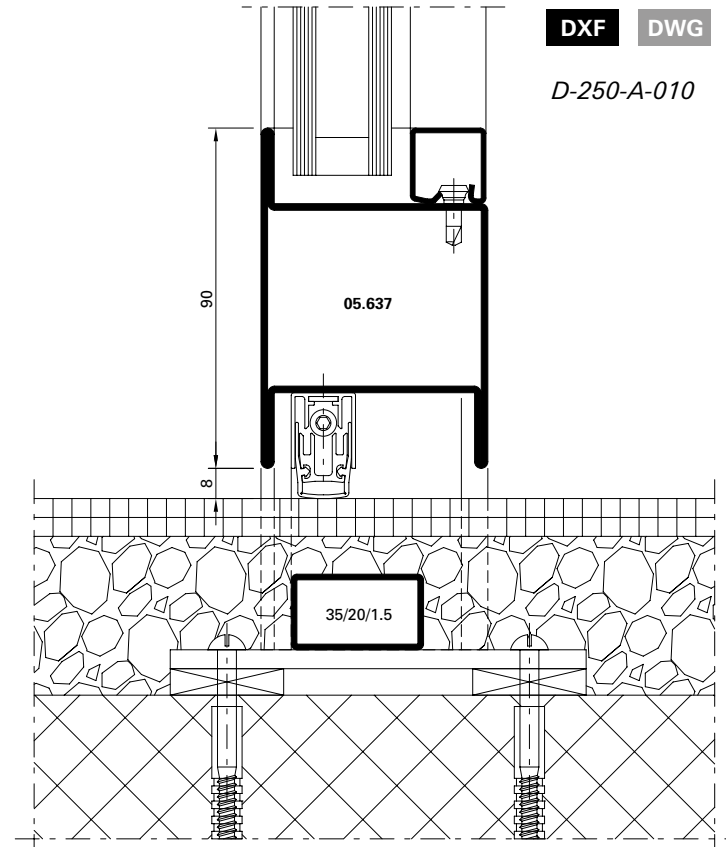
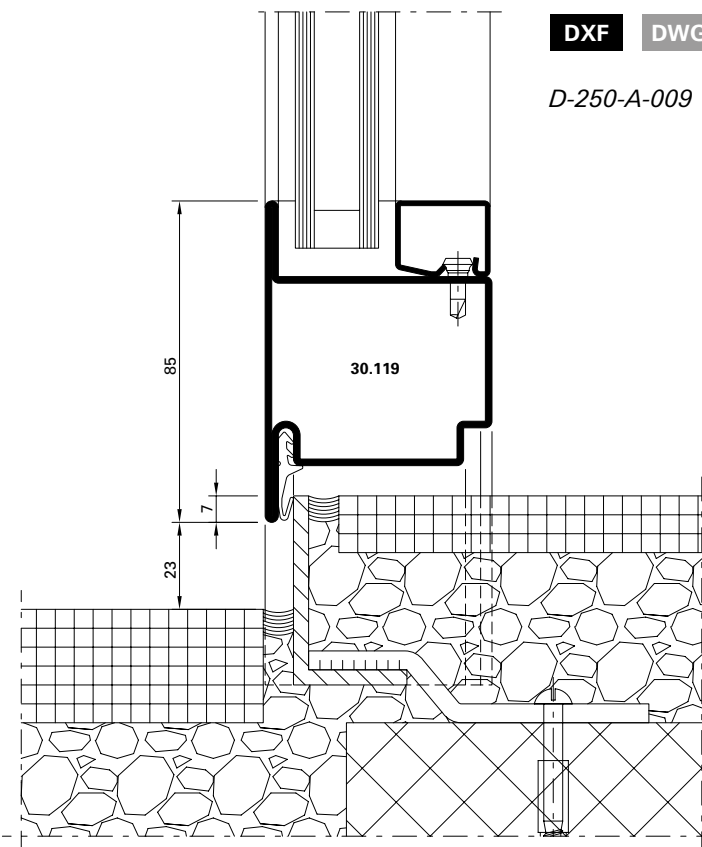
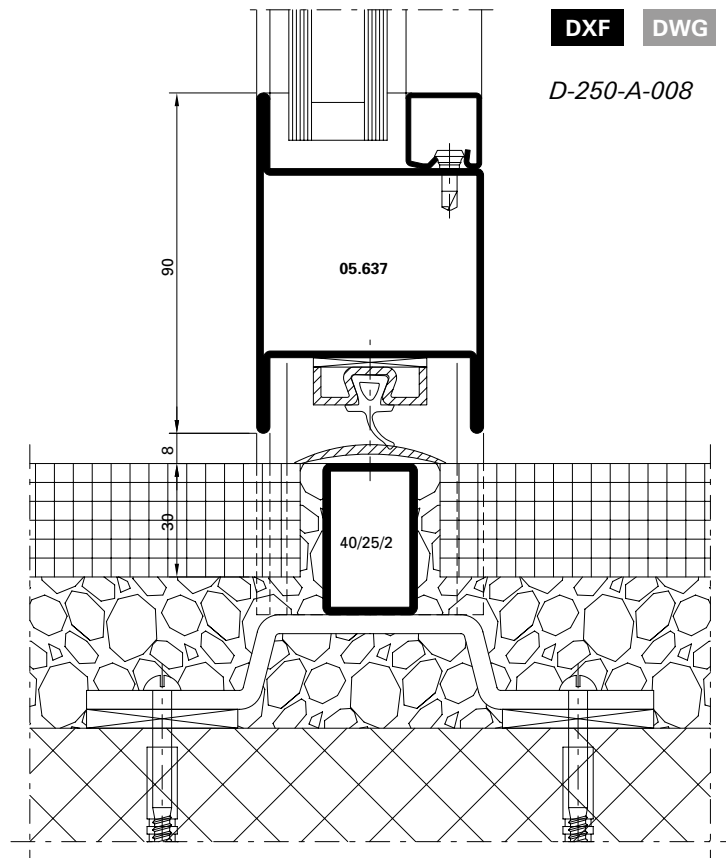
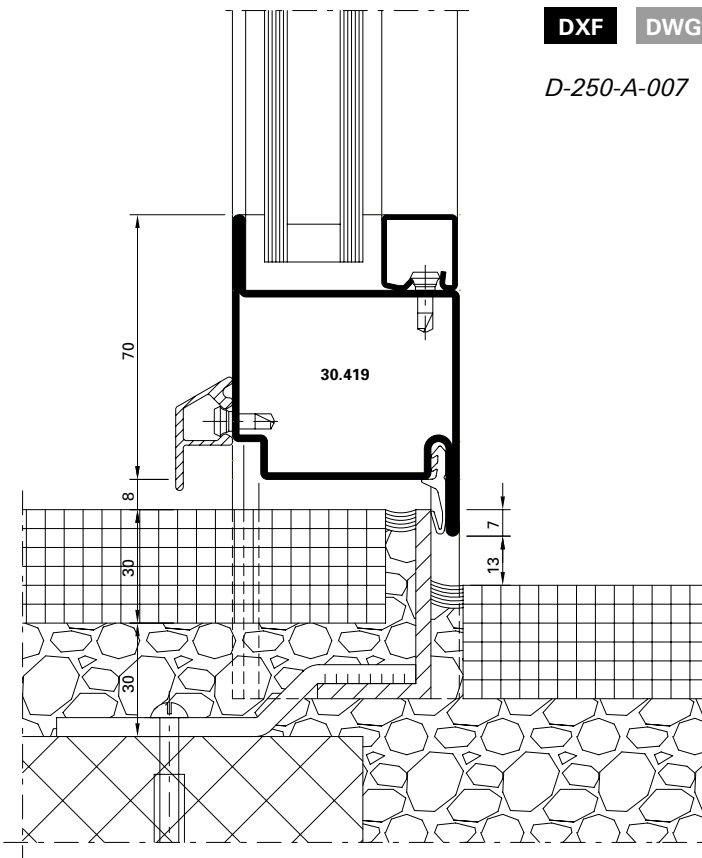



Einflügelige Türen,  
 auswärts öffnend,  
 Flügelhöhe ≤ 2200 mm

Porte à un vantail,  
 ouvrant vers l'extérieur,  
 hauteur du vantail ≤ 2200 mm

Single leaf door,  
 outward opening,  
 leaf height ≤ 2200 mm

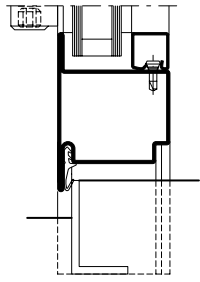
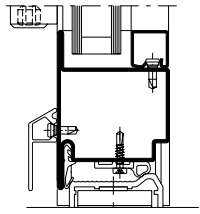
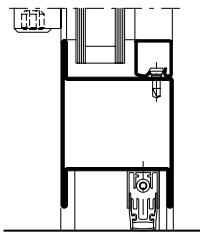
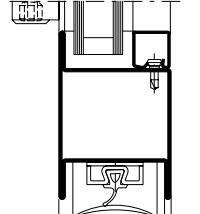
Variante	Beschlag Ferrure Fitting	 EN 12207	 EN 12208	 EN 12210
Anschlagdichtung Joint de butée Rebate gasket 	1	2	1A	C4
	2	2	2A	C4
	3	3	2A	C5
Doppel-Anschlagdichtung Joint de base double Double rebate gasket 	1	4	3A	C4
	2	4	3A	C4
	3	4	5A	C5
Senkdichtung Joint seuil Drop seal 	1	2	1A	C4
	2	2	2A	C4
	3	3	2A	C5
Auflaufdichtung Joint de contact Ramp seal 	1	2	0	C4
	2	2	0	C4
	3	2	0	C5

1 Fallenriegel-Schloss  
 Serrure à mortaiser  
 Latch and bolt lock





2 Schloss mit Obenverriegelung  
 Serrure avec verrouillage supérieur  
 Lock with top locking point

3 Mehrfachverriegelungs-Schloss  
 Serrure à verrouillage multiple  
 Multipoint lock

Einflügelige Türen,  
 einwärts öffnend,  
 Flügelhöhe ≤ 2200 mm

Porte à un vantail,  
 ouvrant vers l'intérieur,  
 hauteur du vantail ≤ 2200 mm

Single leaf door,  
 inward opening,  
 leaf height ≤ 2200 mm

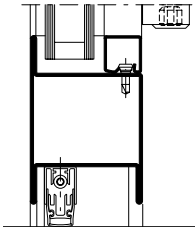
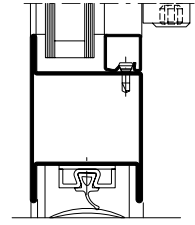
Variante		Beschlag Ferrure Fitting	 EN 12207	 EN 12208	 EN 12210
Senkdichtung Joint seuil Drop seal		❶	2	0	C4
		❷	2	0	C4
		❸	3	1A	C5
Auflaufdichtung Joint de contact Ramp seal		❶	2	0	C4
		❷	2	0	C4
		❸	2	0	C5

❶ Fallenriegel-Schloss  
 Serrure à mortaiser  
 Latch and bolt lock



❷ Schloss mit Obenverriegelung  
 Serrure avec verrouillage supérieur  
 Lock with top locking point

❸ Mehrfachverriegelungs-Schloss  
 Serrure à verrouillage multiple  
 Multipoint lock

Einflügelige Türen,  
 auswärts öffnend,  
 Flügelhöhe ≤ 3000 mm

Porte à un vantail,  
 ouvrant vers l'extérieur,  
 hauteur du vantail ≤ 3000 mm

Single leaf door,  
 outward opening,  
 leaf height ≤ 3000 mm

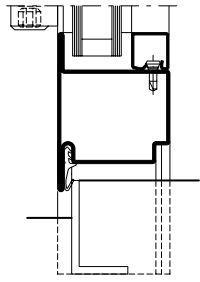
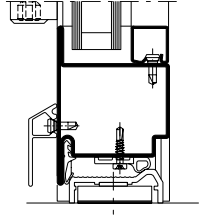
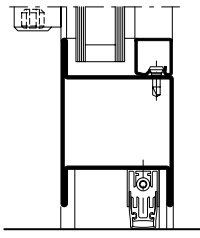
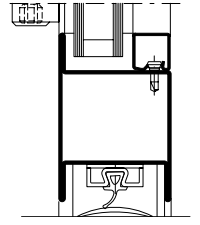
Variante	Beschlag Ferrure Fitting	 EN 12207	 EN 12208	 EN 12210	
Anschlagdichtung Joint de butée Rebate gasket		1	1	0	C1
		2	1	0	C1
		3	1	0	C2
Doppel-Anschlagdichtung Joint de base double Double rebate gasket		1	1	1A	C1
		2	1	1A	C1
		3	2	2A	C2
Senkdichtung Joint seuil Drop seal		1	1	0	C1
		2	1	0	C1
		3	1	0	C2
Auflaufdichtung Joint de contact Ramp seal		1	0	0	C1
		2	0	0	C1
		3	1	0	C2

1 Fallenriegel-Schloss  
 Serrure à mortaiser  
 Latch and bolt lock

2 Schloss mit Obenverriegelung  
 Serrure avec verrouillage supérieur  
 Lock with top locking point





3 Mehrfachverriegelungs-Schloss  
 Serrure à verrouillage multiple  
 Multipoint lock



Einflügelige Türen,  
 einwärts öffnend,  
 Flügelhöhe ≤ 3000 mm

Porte à un vantail,  
 ouvrant vers l'intérieur,  
 hauteur du vantail ≤ 3000 mm

Single leaf door,  
 inward opening,  
 leaf height ≤ 3000 mm

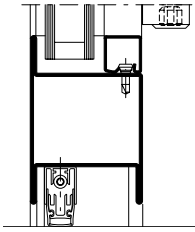
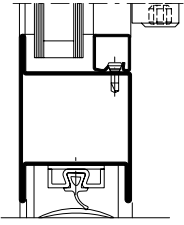
Variante		Beschlag Ferrure Fitting	 EN 12207	 EN 12208	 EN 12210
Senkdichtung Joint seuil Drop seal		❶	1	0	C1
		❷	1	0	C1
		❸	1	0	C2
Auflaufdichtung Joint de contact Ramp seal		❶	0	0	C1
		❷	0	0	C1
		❸	1	0	C2

❶ Fallenriegel-Schloss  
 Serrure à mortaiser  
 Latch and bolt lock



❷ Schloss mit Obenverriegelung  
 Serrure avec verrouillage supérieur  
 Lock with top locking point

❸ Mehrfachverriegelungs-Schloss  
 Serrure à verrouillage multiple  
 Multipoint lock

Zweiflügelige Türen,  
 auswärts öffnend,  
 Flügelhöhe ≤ 2200 mm

Porte à deux vantaux,  
 ouvrant vers l'extérieur,  
 hauteur du vantail ≤ 2200 mm

Double leaf door,  
 outward opening,  
 leaf height ≤ 2200 mm

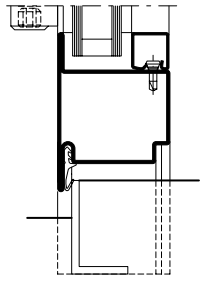
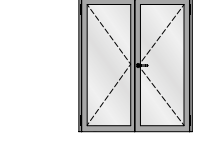
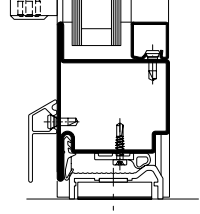
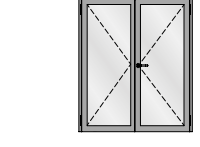
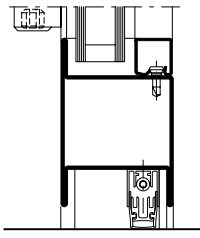
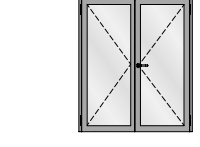
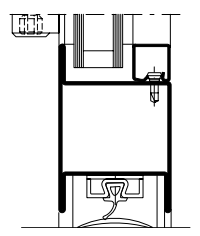
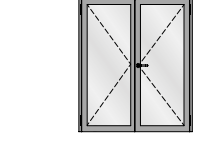
Variante	Beschlag Ferrure Fitting	 EN 12207	 EN 12208	 EN 12210	
Anschlagdichtung Joint de butée Rebate gasket 	Beschlag Ferrure Fitting 	1	2	1A	C2
		2	2	2A	C2
		3	2	2A	C3
Doppel-Anschlagdichtung Joint de base double Double rebate gasket 	Beschlag Ferrure Fitting 	1	2	2A	C2
		2	2	2A	C2
		3	3	3A	C3
Senkdichtung Joint seuil Drop seal 	Beschlag Ferrure Fitting 	1	2	1A	C2
		2	2	2A	C2
		3	2	2A	C3
Auflaufdichtung Joint de contact Ramp seal 	Beschlag Ferrure Fitting 	1	2	0	C2
		2	2	0	C2
		3	2	0	C3

**1** Fallenriegel-Schloss  
 Serrure à mortaiser  
 Latch and bolt lock





**2** Schloss mit Obenverriegelung  
 Serrure avec verrouillage supérieur  
 Lock with top locking point

**3** Mehrfachverriegelungs-Schloss  
 Serrure à verrouillage multiple  
 Multipoint lock

Zweiflügelige Türen,  
 einwärts öffnend,  
 Flügelhöhe ≤ 2200 mm

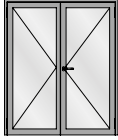
Porte à deux vantaux,  
 ouvrant vers l'intérieur,  
 hauteur du vantail ≤ 2200 mm

Double leaf door,  
 inward opening,  
 leaf height ≤ 2200 mm

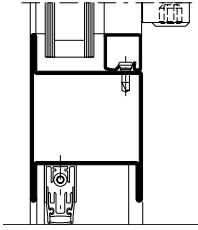
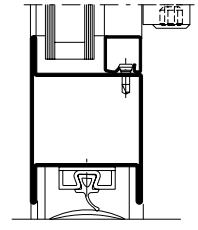
Variante		Beschlag Ferrure Fitting	 EN 12207	 EN 12208	 EN 12210
Senkdichtung Joint seuil Drop seal		❶	2	0	C2
		❷	2	0	C2
		❸	2	0	C3
Auflaufdichtung Joint de contact Ramp seal		❶	2	0	C2
		❷	2	0	C2
		❸	2	0	C3

❶ Fallenriegel-Schloss  
 Serrure à mortaiser  
 Latch and bolt lock



❷ Schloss mit Obenverriegelung  
 Serrure avec verrouillage supérieur  
 Lock with top locking point

❸ Mehrfachverriegelungs-Schloss  
 Serrure à verrouillage multiple  
 Multipoint lock

Zweiflügelige Türen,  
 auswärts öffnend,  
 Flügelhöhe ≤ 3000 mm

Porte à deux vantaux,  
 ouvrant vers l'extérieur,  
 hauteur du vantail ≤ 3000 mm

Double leaf door,  
 outward opening,  
 leaf height ≤ 3000 mm

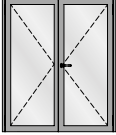
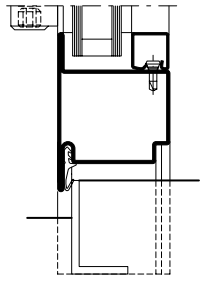
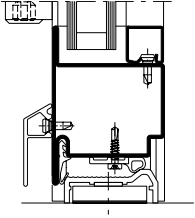
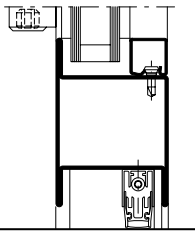
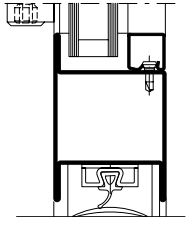
Variante	Beschlag Ferrure Fitting	 EN 12207	 EN 12208	 EN 12210	
					
Anschlagdichtung Joint de butée Rebate gasket		1	0	0	C1
		2	0	0	C1
		3	1	0	C2
Doppel-Anschlagdichtung Joint de base double Double rebate gasket		1	1	0	C1
		2	1	0	C1
		3	2	0	C2
Senkdichtung Joint seuil Drop seal		1	0	0	C1
		2	0	0	C1
		3	1	0	C2
Auflaufdichtung Joint de contact Ramp seal		1	0	0	C1
		2	0	0	C1
		3	1	0	C2

1 Fallenriegel-Schloss  
 Serrure à mortaiser  
 Latch and bolt lock





2 Schloss mit Obenverriegelung  
 Serrure avec verrouillage supérieur  
 Lock with top locking point

3 Mehrfachverriegelungs-Schloss  
 Serrure à verrouillage multiple  
 Multipoint lock

Zweiflügelige Türen,  
 einwärts öffnend,  
 Flügelhöhe ≤ 3000 mm

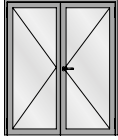
Porte à deux vantaux,  
 ouvrant vers l'intérieur,  
 hauteur du vantail ≤ 3000 mm

Double leaf door,  
 inward opening,  
 leaf height ≤ 3000 mm

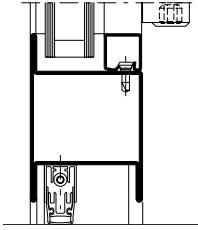
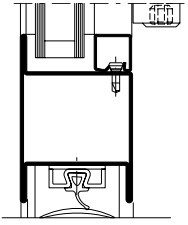
Variante		Beschlag Ferrure Fitting	 EN 12207	 EN 12208	 EN 12210
Senkdichtung Joint seuil Drop seal		1	0	0	C1
		2	0	0	C1
		3	1	0	C2
Auflaufdichtung Joint de contact Ramp seal		1	0	0	C1
		2	0	0	C1
		3	1	0	C2

**U<sub>f</sub>-Werte**  
(nach EN ISO 10077-2:2018-01)

**Valeurs U<sub>f</sub>**  
(selon EN ISO 10077-2:2018-01)

**U<sub>f</sub> values**  
(according to  
EN ISO 10077-2:2018-01)

Auf den folgenden Seiten  
finden Sie die U<sub>f</sub>-Werte für die  
verschiedenen Anwendungen von  
Jansen-Economy 60.

Vous trouverez les valeurs U<sub>f</sub>  
pour les différentes applications  
Jansen-Economy 60 dans les  
pages qui suivent.

On the following pages you  
will find the U<sub>f</sub> values for the  
various applications for  
Jansen-Economy 60.

Sie basieren auf folgenden  
Grundlagen:

Elles se basent sur les principes  
suivants:

They are based on the following:

**Stahl**

- Profile bandverzinkter Stahl,  
unbeschichtet
- Stahl-Glasleisten
- Trockenverglasung
- Nassverglasung

**Acier**

- Profilés en bande d'acier zingué,  
sans revêtement
- Parcloses en acier
- Vitrage à sec
- Vitrage à mastic



**Steel**

- Strip galvanised steel profiles,  
uncoated
- Steel glazing beads
- Glazing with dry glazing
- Glazing with sealing

**U<sub>f</sub>-Werte**  
 (nach EN ISO 10077-2:2018-01)

**Valeurs U<sub>f</sub>**  
 (selon EN ISO 10077-2:2018-01)

**U<sub>f</sub> values**  
 (according to EN ISO 10077-2:2018-01)

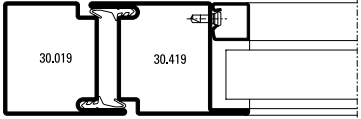
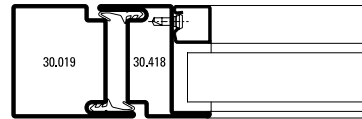
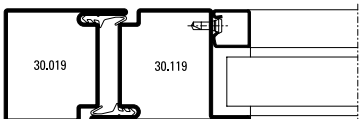
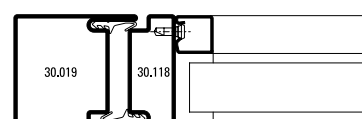
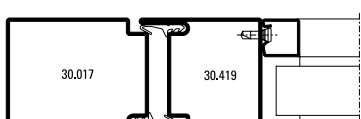
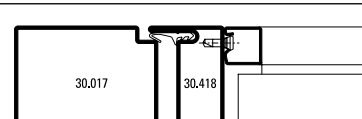
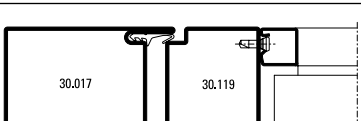
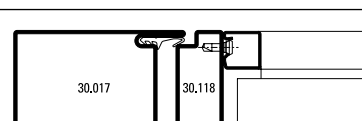
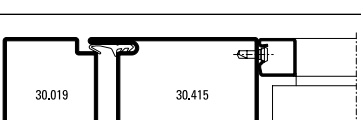
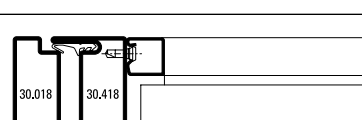
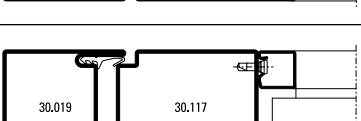
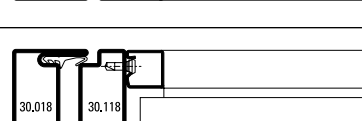
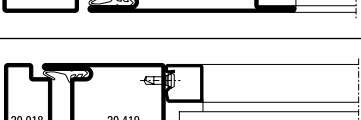
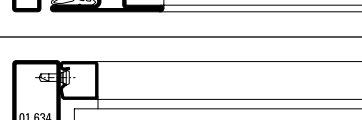
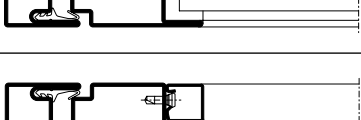
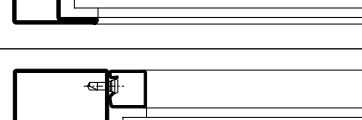
 Füllelementstärken Elements de remplissages Infill elements ≥ 24 mm		 Füllelementstärken Elements de remplissages Infill elements ≥ 24 mm	
 30.019 30.419	5,5 W/m <sup>2</sup> K	 30.019 30.418	5,7 W/m <sup>2</sup> K
 30.019 30.119	5,6 W/m <sup>2</sup> K	 30.019 30.118	5,8 W/m <sup>2</sup> K
 30.017 30.419	5,3 W/m <sup>2</sup> K	 30.017 30.418	5,5 W/m <sup>2</sup> K
 30.017 30.119	5,3 W/m <sup>2</sup> K	 30.017 30.118	5,5 W/m <sup>2</sup> K
 30.019 30.415	5,3 W/m <sup>2</sup> K	 30.018 30.418	6,0 W/m <sup>2</sup> K
 30.019 30.117	5,3 W/m <sup>2</sup> K	 30.018 30.118	6,1 W/m <sup>2</sup> K
 30.018 30.419	5,6 W/m <sup>2</sup> K	 01.634	6,9 W/m <sup>2</sup> K
 30.018 30.119	5,7 W/m <sup>2</sup> K	 01.684	6,1 W/m <sup>2</sup> K

**U<sub>f</sub>-Werte**  
 (nach EN ISO 10077-2:2018-01)

**Valeurs U<sub>f</sub>**  
 (selon EN ISO 10077-2:2018-01)

**U<sub>f</sub> values**  
 (according to EN ISO 10077-2:2018-01)

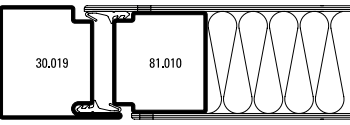
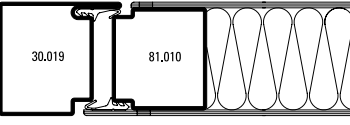
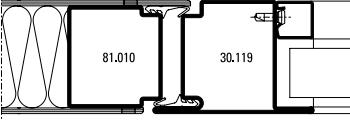
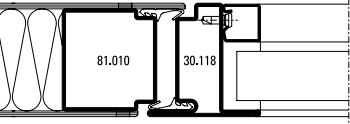
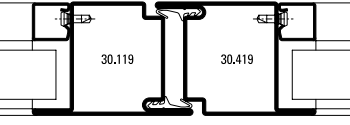
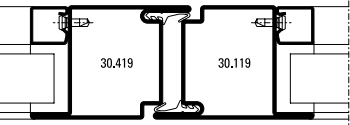
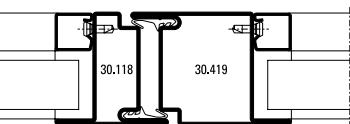
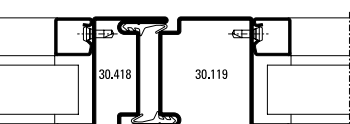
 © ift Rosenheim	Füllelementstärken Elements de remplissages Infill elements
	≥ 24 mm
	5,3 W/m²K
	5,3 W/m²K
	5,7 W/m²K
	6,0 W/m²K
	5,8 W/m²K
	5,8 W/m²K
	6,1 W/m²K
	6,1 W/m²K

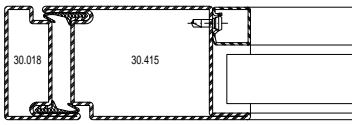
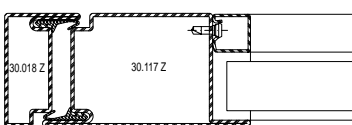
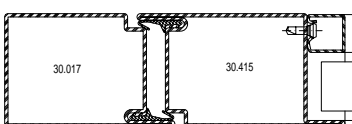
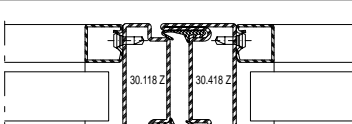
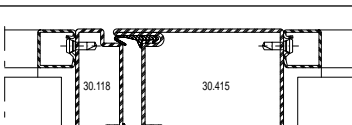
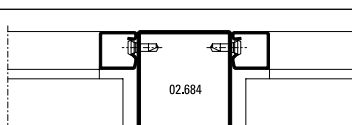
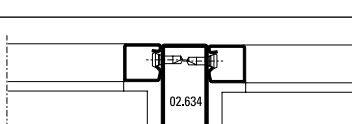
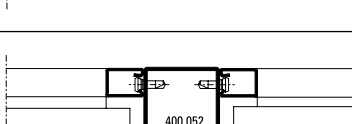
 © ift Rosenheim	Füllelementstärken Elements de remplissages Infill elements
	≥ 24 mm
	5,3 W/m²K
	5,4 W/m²K
	5,1 W/m²K
	6,5 W/m²K
	5,7 W/m²K
	6,3 W/m²K
	7,2 W/m²K
	6,4 W/m²K



**U<sub>f</sub>-Werte**  
 (nach EN ISO 10077-2:2018-01)



**Valeurs U<sub>f</sub>**  
 (selon EN ISO 10077-2:2018-01)

**U<sub>f</sub> values**  
 (according to EN ISO 10077-2:2018-01)

	Füllelementstärken Elements de remplissages Infill elements  ≥ 24 mm
	5,5 W/m <sup>2</sup> K
	5,7 W/m <sup>2</sup> K
	5,5 W/m <sup>2</sup> K
	5,3 W/m <sup>2</sup> K
	5,3 W/m <sup>2</sup> K

	Füllelementstärken Elements de remplissages Infill elements  ≥ 24 mm
	5,8 W/m <sup>2</sup> K
	6,0 W/m <sup>2</sup> K
	5,4 W/m <sup>2</sup> K
	5,1 W/m <sup>2</sup> K

**U<sub>f</sub>-Werte**  
 (nach EN ISO 10077-2:2018-01)

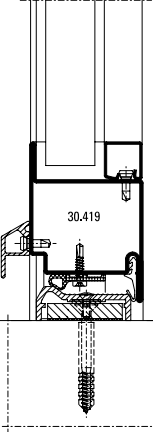
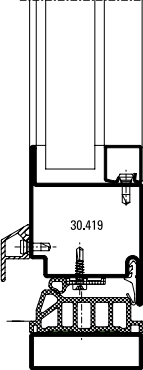
 Füllelementstärken Elements de remplissages Infill elements ≥ 24 mm	
 01.684	6,1 W/m <sup>2</sup> K
 30.419	6,3 W/m <sup>2</sup> K
 30.419	5,6 W/m <sup>2</sup> K

**Valeurs U<sub>f</sub>**  
 (selon EN ISO 10077-2:2018-01)

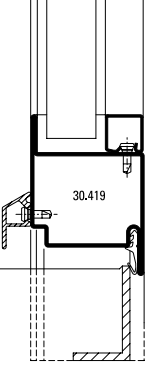
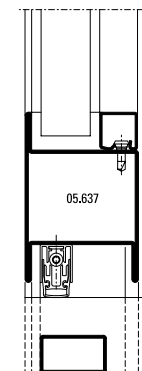
 Füllelementstärken Elements de remplissages Infill elements ≥ 24 mm	
 30.419	6,3 W/m <sup>2</sup> K
 05.637	5,6 W/m <sup>2</sup> K

**U<sub>f</sub> values**  
 (according to EN ISO 10077-2:2018-01)

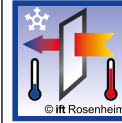
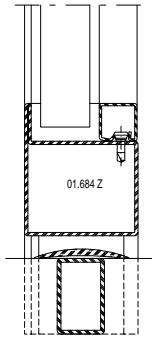
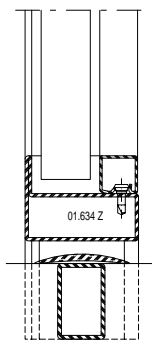
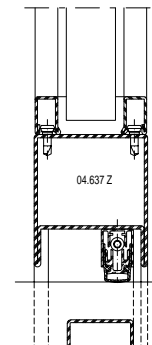
 Füllelementstärken Elements de remplissages Infill elements ≥ 24 mm	
 01.684 Z	6,1 W/m <sup>2</sup> K
 01.634 Z	6,8 W/m <sup>2</sup> K
 04.637 Z	5,5 W/m <sup>2</sup> K

**U<sub>f</sub>-Werte**  
 (nach EN ISO 10077-2:2018-01)

**Valeurs U<sub>f</sub>**  
 (selon EN ISO 10077-2:2018-01)

**U<sub>f</sub> values**  
 (according to EN ISO 10077-2:2018-01)

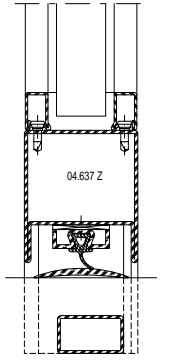
 Füllelementstärken Elements de remplissages Infill elements ≥ 24 mm	
	5,6 W/m <sup>2</sup> K

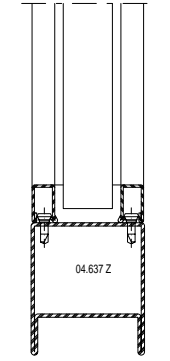
 Füllelementstärken Elements de remplissages Infill elements ≥ 24 mm	
	5,6 W/m <sup>2</sup> K

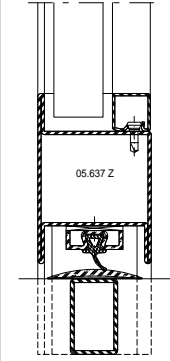
 Füllelementstärken Elements de remplissages Infill elements ≥ 24 mm	
	5,7 W/m <sup>2</sup> K

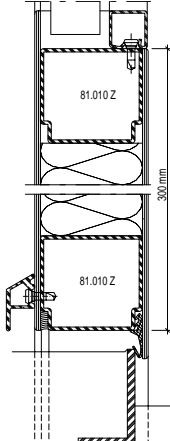
	4,4 W/m <sup>2</sup> K
--	------------------------

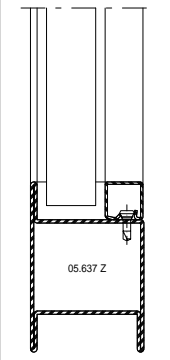
	5,7 W/m <sup>2</sup> K
--	------------------------

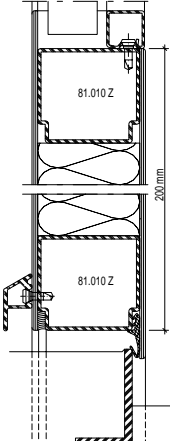
	5,2 W/m <sup>2</sup> K
---	------------------------



## Schallschutz

### Ausführungsvarianten

Die nachfolgende Typenübersicht ergibt einen Überblick über die beurteilten Varianten.

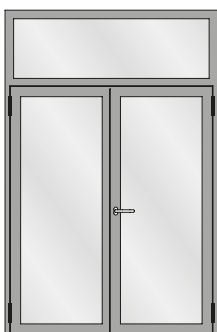
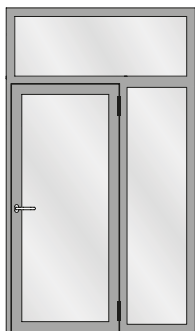
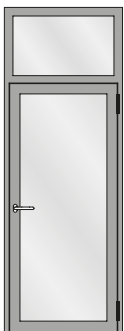
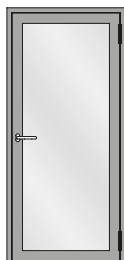

## Isolation phonique

### Modèles

L'aperçu des types suivant fournit une vue d'ensemble des variantes examinées.

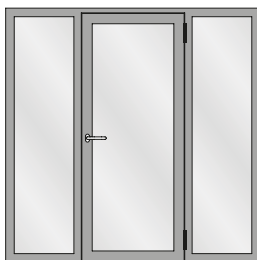
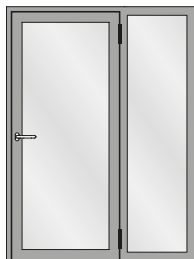
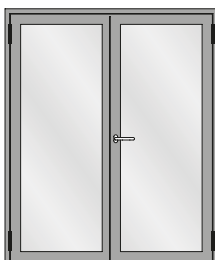

## Sound insulation

### Design range

The following overview of types provides an overview of the evaluated designs.

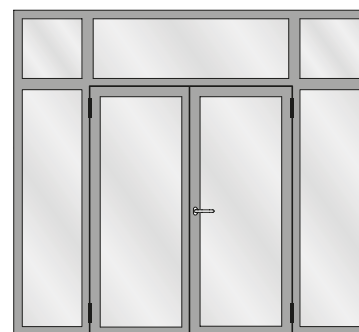
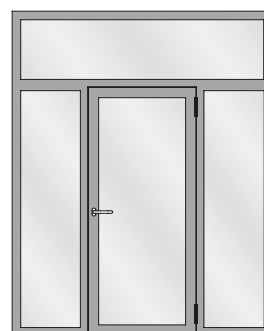

Schallschutz

Isolation phonique

Sound insulation

Tabelle A1

Korrekturtabelle für Jansen-Economy-Türen mit Glasfüllungen

Tableau A1

Tableau de correction pour les portes Jansen-Economy avec vitrage

Table A1

Correction table for Jansen-Economy doors with glass

	1	2	3	4	5	6	7	8	9	10	11
	<b>Türe</b> mit zwei absenkba- ren Bodendichtungen <b>Porte</b> avec deux joint seuil automatique <b>Door</b> with two threshold gaskets that can be lowered	<b>Glas</b>  <b>Verre</b>  <b>Glass</b>	<b>Korrekturen</b>  <b>Corrections</b>  <b>Corrections</b>								
	$R_{w(C, Ctr)}$ dB	$R_{w, P, Glas}$ dB	$K_S$ dB	$K_{FV}$ dB	$K_{Nass}$ dB	$K_{1aB}$ dB	$K_{W/S}$ dB	$K_{G 0,4}$ dB	$K_{G 1,8}$ dB	$K_{G 2,6}$ dB	$K_{G 3,2}$ dB
1	32 (-1; -5)	31	0	-1	0	0	0	0	-1	-2	-3
2	33 (-1; -5)	32	0	-1	0	0	0	0	-1	-2	-3
3	35 (-1; -5)	34	0	-1	0	0	0	0	-1	-2	-3
4	36 (-2; -5)	35	0	-1	-1	0	0	0	-1	-2	-3
5	37 (-2; -5)	37	0	0	-1	0	-1	0	-1	-2	-3
6	38 (-2; -5)	39	0	0	-1	-1	-1	0	-1	-2	-3
7	39 (-2; -5)	40	0	0	-1	-1	-1	0	-1	-2	-3
8	40 (-2; -5)	41	0	0	-1	-1	-2	-1	-1	-2	-3
9	41 (-2; -5)	42	0	0	-1	-1	-2	-2	-1	-2	-3
10	42 (-2; -5)	43	-1	0	-1	-1	-2	-2	-1	-2	-3
11	42 (-2; -5)	44	-1	0	-1	-1	-2	-2	-1	-2	-3
12	43 (-2; -5)	45	-1	+1	-1	-1	-3	-3	-1	-2	-3
13	44 (-2; -5)	49	-1	+1	-1	-2	-3	-3	-1	-2	-3

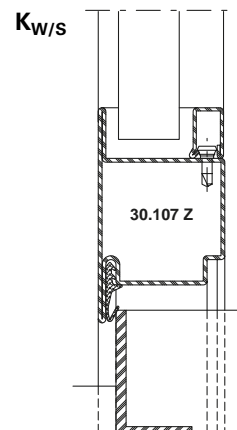
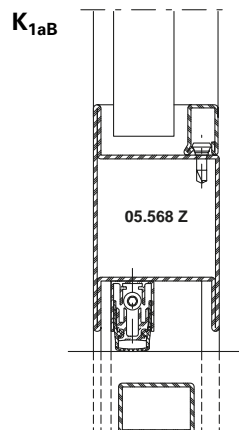
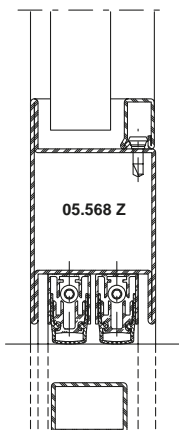

**Schallschutz**

**Isolation phonique**

**Sound insulation**

*Der aus der Tabelle A1 abzulesende Wert für die Schalldämmung  $R_{w, Tür}$  beträgt:*

*La valeur à relever sur le tableau A1 concernant l'isolement contre les sons aériens  $R_{w, Porte}$  est la suivante:*

*The value taken from table A1 for the sound insulation  $R_{w, Door}$  is:*

$$R_{w, Tür} = R_w + K_S + K_{FV} + K_{Nass} + K_{1aB} + K_{W/S} + K_{Band} + K_{G 0,4} + K_{G 1,8} + K_{G 2,6} + K_{G 3,2} \text{ dB}$$

- $R_w$**  bewertetes Schalldämm-Mass der Türe in Abhängigkeit von der Schalldämmung  $R_{w,P, Glas}$
- $R_{w,P, Glas}$**  bewertetes Schalldämm-Mass der Verglasung (Prüfwert nach ISO 140-3, mit Prüfnachweis einer PÜZ-Stelle). Alternativ können Tabellenwerte nach DIN EN 12758, Abschnitt 6 verwendet werden
- $K_S$**  Korrekturwert für zweiflügelige Türen
- $K_{FV}$**  Korrekturwert für Festverglasungen mit erhöhtem Scheibenanteil
- $K_{Nass}$**  Korrekturwert für Nassverglasung
- $K_{1aB}$**  Korrekturwert für Türen mit einer absenkbaren Bodendichtung
- $K_{Band}$**  Korrekturwert bei Verwendung von Anschlagbändern, die eine Dichtungsebene unterbrechen ( $K_{Band} = - 0,5 \text{ dB pro Band}$ )
- $K_{W/S}$**  Korrekturwert für Türen mit einer Anschlagsschwelle
- $K_{G 0,4}$**  Korrekturwert für Einzelscheiben mit einer Glasfläche  $\leq 0,4 \text{ m}^2$ . Die Korrektur gilt auch für Konstruktionen mit glasteilenden Sprossen.
- $K_{G 1,8}$**  Korrekturwert für Einzelscheiben mit einer Glasfläche  $\geq 1,8 \text{ m}^2$
- $K_{G 2,6}$**  Korrekturwert für Einzelscheiben mit einer Glasfläche  $\geq 2,6 \text{ m}^2$
- $K_{G 3,2}$**  Korrekturwert für Einzelscheiben mit einer Glasfläche  $\geq 3,2 \text{ m}^2$

- $R_w$**  Mesure d'isolement contre les sons aériens des portes évaluée suivant l'isolement phonique  $R_{w,P, Glas}$
- $R_{w,P, Glas}$**  Cote d'isolement acoustique du vitrage évalué (valeur contrôlée selon ISO 140-3 avec certificat d'un bureau de contrôle, de surveillance ou de certification). Il est également possible d'utiliser les valeurs selon le tableau DIN EN 12758, section 6
- $K_S$**  Valeur de correction pour portes à deux vantaux
- $K_{FV}$**  Valeur de correction pour vitrages fixes à fort pourcentage de vitre
- $K_{Nass}$**  Valeur de correction pour vitrage avec mastic
- $K_{1aB}$**  Valeur de correction pour portes avec un joint seuil automatique
- $K_{Band}$**  Valeur corrective en cas d'utilisation de paumelles qui interrompent un plan d'étanchéité ( $K_{Band} = - 0,5 \text{ dB par paumelle}$ )
- $K_{W/S}$**  Valeur de correction pour portes avec un seuil de butée
- $K_{G 0,4}$**  Valeur de correction pour vitres individuelles avec une surface vitrée  $\leq 0,4 \text{ m}^2$ . La correction s'applique aussi aux constructions à meneaux séparant les vitres.
- $K_{G 1,8}$**  Valeur de correction pour vitres individuelles avec surface vitrée  $\geq 1,8 \text{ m}^2$
- $K_{G 2,6}$**  Valeur de correction pour vitres individuelles avec surface vitrée  $\geq 2,6 \text{ m}^2$
- $K_{G 3,2}$**  Valeur de correction pour vitres individuelles avec surface vitrée  $\geq 3,2 \text{ m}^2$

- $R_w$**  Airborne sound reduction index of doors depending on the sound insulation  $R_{w,P, Glas}$
- $R_{w,P, Glas}$**  Airborne sound reduction index (test value in accordance with ISO 140-3, with a test certificate from a recognised testing, inspection or certification body). Alternatively, the tabulated values in DIN EN 12758, Section 6 may be used
- $K_S$**  Correction value for double-leaf doors
- $K_{FV}$**  Correction value for fixed glazing with increased proportion of pane
- $K_{Nass}$**  Correction value for glazing with sealing
- $K_{1aB}$**  Correction value for doors with a threshold gasket that can be lowered
- $K_{Band}$**  Correction value when using hinges that interrupt a sealing plane ( $K_{Band} = - 0.5 \text{ dB per hinge}$ )
- $K_{W/S}$**  Correction value for doors with a rebate threshold
- $K_{G 0,4}$**  Correction value for single panes with a glass area  $\leq 0,4 \text{ m}^2$ . The correction also applies to buildings with glazing bars
- $K_{G 1,8}$**  Correction value for single panes with a glass area  $\geq 1,8 \text{ m}^2$
- $K_{G 2,6}$**  Correction value for single panes with a glass area  $\geq 2,6 \text{ m}^2$
- $K_{G 3,2}$**  Correction value for single panes with a glass area  $\geq 3,2 \text{ m}^2$



# Jansen-Economy 60 Türen

Türen aus Stahl

# Portes Jansen-Economy 60

Portes en acier

# Jansen-Economy 60 doors

Doors in steel



Grafische Planungsdaten wie z.B. Anwendungsbeispiele, Konstruktionsdetails, Anschlüsse am Bau, die in unseren physischen oder elektronischen Dokumentationsunterlagen enthalten sind, sind schematische Darstellungen. Gleiches gilt für digitale Medien wie CAD Dateien oder BIM Modelle.

Sie sollen den ausführenden Metallbauer und/oder Fachplaner bei der Planung und Ausführung eines Projektes unterstützen. Sie sind im konkreten Anwendungsfall durch den ausführenden Metallbauer und/oder Fachplaner auf die Verwendbarkeit im konkreten betroffenen Projekt hinsichtlich rechtlichen/regulatorischen aber auch technischen objektspezifischen Anforderungen zu überprüfen und ggfs. eigenverantwortlich anzupassen.

Bei der Überprüfung, der spezifischen Planung und der Umsetzung sind die objektspezifischen Rahmenbedingungen (Material der Bausubstanz, Dimension des Einbauelements, Farbe, Exposition, Lasteinwirkung, etc.) sowie der geltende Stand der Technik einschliesslich aller anwendbaren Normen und technischen Richtlinien eigenverantwortlich zu beachten.

Falls das vorliegende Dokument Differenzen zur aktuellen deutschen Version (Artikel Nr. K1214237) aufweist, gilt in jedem Fall der deutsche Originaltext in der jeweils geltenden Fassung im Jansen Docu Center.

Alle Ausführungen dieser Dokumentation haben wir sorgfältig und nach bestem Wissen zusammengestellt. Wir können aber keine Verantwortung für die Benutzung der vermittelten Vorschläge und Daten übernehmen. Wir behalten uns technische Änderungen ohne Vorankündigung vor.

Les données de planification graphiques, comme les exemples d'application, détails de construction et raccordements au bâtiment, fournies dans notre documentation physique et numérique sont des représentations schématiques. Il en va de même pour les médias numériques comme les fichiers CAD ou modèles BIM.

Leur but est de faciliter la planification et réalisation d'un projet par les constructeurs métalliques et/ou concepteurs. Concrètement, elles doivent être vérifiées par le constructeur métallique et/ou le concepteur et, le cas échéant, modifiées de son propre chef pour s'assurer qu'elles concordent avec le projet concerné et qu'elles répondent aux exigences techniques spécifiques ainsi qu'aux dispositions légales et réglementaires.

Lors de la vérification, de la planification spécifique et de la mise en œuvre, il y a lieu de tenir compte des conditions spécifiques à l'objet (matériaux du bâtiment, dimension de l'élément d'insert, couleur, exposition, effet de charge, etc.) ainsi que de l'état actuel de la technique, y compris toutes les normes et directives techniques applicables.

En cas de divergence entre le présent document et la version allemande (no d'article K1214237), c'est dans tous les cas le texte original allemand qui prévaut dans sa version actuelle disponible dans le Jansen Docu Center.

Nous avons apporté le plus grand soin à l'élaboration de cette documentation. Cependant, nous déclinons toute responsabilité pour l'utilisation faite de nos propositions et de nos données.

Nous nous réservons le droit de procéder à des modifications techniques sans préavis.

Graphical planning data such as application examples, construction details, connections on site that are contained in our physical or electronic documentation components are schematic representations. The same applies to digital media such as CAD files or BIM models.

They are intended to support the metal worker and/or design engineer in planning and executing projects. In the specific case of application they are to be checked by the metal worker and/or design engineer in terms of their usability in the specific project concerned with regard to legal/regulatory and technical property-specific requirements and adjusted if necessary at the latter's own responsibility.

The property-specific underlying conditions (construction material, dimensions of installation element, colour, exposure, load effect etc.) and current state of the art including all applicable norms and technical guidelines are to be taken into consideration at the metal worker and/or design engineer's own responsibility during the review, specific planning and implementation.

If there are any differences between this document and the current German version (item number K1214237), the latest version of the original German text in the Jansen Docu Center shall prevail.

All the information contained in this documentation is given to the best of our knowledge and ability. However, we decline all responsibility for the use made of these suggestions and data.

We reserve the right to effect technical modifications without prior warning.

<p><b>Inhaltsverzeichnis</b>  <b>Sommaire</b>  <b>Content</b></p>		<p>Jansen-Economy 60 Türen  Jansen-Economy 60 portes  Jansen-Economy 60 doors</p>
<p><b>Systemübersicht</b>  Merkmale  Leistungseigenschaften  Systemausführungen  Typenübersicht</p>	<p><b>Sommaire du système</b>  Caractéristiques  Caractéristiques de performance  Exécutions de système  Sommaire des types</p>	<p><b>Summary of system</b>  Characteristics  Performance characteristics  System versions  Summary of types</p> <p><b>2</b></p>
<p><b>Profilsortiment</b></p>	<p><b>Assortiment de profilé</b></p>	<p><b>Range of profiles</b></p> <p><b>14</b></p>
<p><b>Beispiele</b>  Schnittpunkte  Konstruktionsdetails  Anschlüsse am Bau</p>	<p><b>Exemples</b>  Coupes de détails  Détails de construction  Raccords au mur</p>	<p><b>Examples</b>  Section details  Construction details  Attachment to structure</p> <p><b>18</b></p>
<p><b>Leistungseigenschaften</b></p>	<p><b>Caractéristiques de performance</b></p>	<p><b>Performance characteristics</b></p> <p><b>36</b></p>







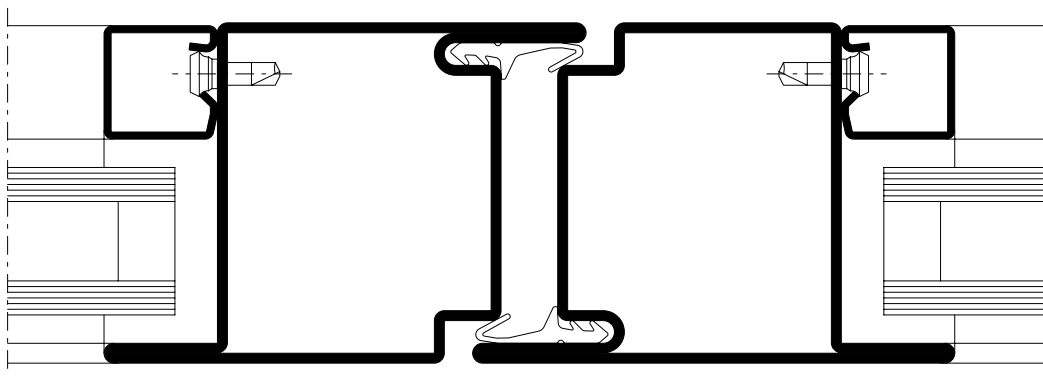

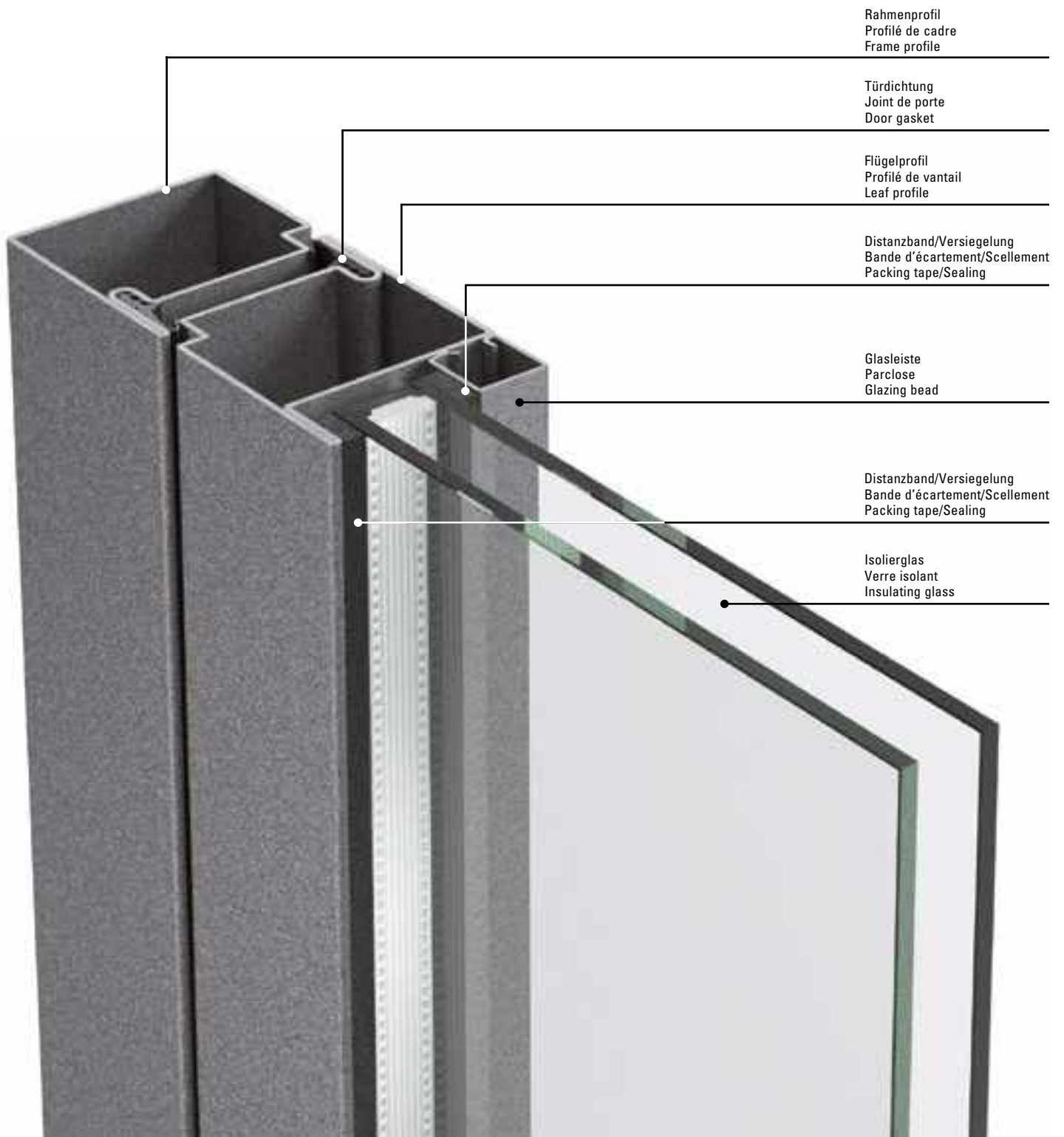

**Merkmale**  
**Caractéristiques**  
**Characteristics**





Jansen-Economy 60 Türen  
Jansen-Economy 60 portes  
Jansen-Economy 60 doors

- Stahlsystem für Türen und Festverglasungen
- Bautiefe 60 mm, innen und aussen flächenbündig
- Schmale Ansichtsbreiten: Rahmen und Flügel ab 105 mm Stulppartie 150 mm
- Ein- und zweiflüglige Türen, nach innen und aussen öffnend, mit Oberlicht oder Festverglasung kombinierbar
- Türflügel bis 1465 x 3000 mm (BxH), Flügelgewicht bis 230 kg
- Füllelementstärke von 5 bis 36 mm, Glaseinbau mittels Trocken- oder Nassverglasung
- Systemprüfungen nach Produktnorm EN 14351-1
- Stahlprofile blank oder bandverzinkt
- Grosses Sortiment an systemgeprüften Türbeschlägen
- Barrierefreie Schwellenausbildungen
- Geeignet für Pulver- und Nasslackbeschichtungen
- Système en acier pour portes et vitrages fixes
- Profondeur de montage 60 mm, montage à fleur à l'intérieur et à l'extérieur
- Fines largeurs de face: Cadre et vantaux à partir de 105 mm Partie tête 150 mm
- Portes à un et deux vantaux, ouverture vers l'intérieur et vers l'extérieur, combinables avec imposte ou vitrage fixe
- Vantaux de porte jusqu'à 1465 x 3000 mm (LaxH), poids du vantail jusqu'à 230 kg
- Élément de remplissage de 5 à 36 mm d'épaisseur, Montage du vitrage à sec ou à silicone
- Contrôles des systèmes selon la norme produit EN 14351-1
- Profilés en acier brut ou galvanisé en continu
- Grand assortiment de ferrures de porte homologuées
- Formes de seuil sans barrière
- Convient aux revêtements par poudre ou peinture liquide
- Steel system for doors and fixed glazing
- 60 mm basic depth, flush-fitted on the inside and outside
- Narrow face widths: Frame and leaf from 105 mm Meeting stile assembly 150 mm
- Single and double-leaf doors, inward and outward-opening, can be combined with toplight or fixed glazing
- Door leaf up to 1465 x 3000 mm (WxH), leaf weight up to 230 kg
- Infill unit thickness of 5 to 36 mm, Glazing installed by means of dry or wet glazing
- System tests in accordance with the product standard EN 14351-1
- Raw finish or pre-galvanised steel profiles
- Large range of system-tested door fittings
- Easy-access thresholds
- Suitable for powder and wet paint coating





Norm	Eigenschaft Caractéristique Characteristic	Klassifizierung/Wert Classification / Valeur Classification / Value											
 EN 12210	<b>Widerstandsfähigkeit bei Windlast</b> <b>Résistance à la pression du vent</b> <b>Resistance to wind load</b>	npd	1 (400)	2 (800)	3 (1200)	4 (1600)	5 (2000)	Exxx (>2000)					
 EN 12208	<b>Schlagregendichtheit</b> <b>Étanchéité à la pluie battante</b> <b>Watertightness</b>	npd	1A (0)	2A (50)	3A (100)	4A (150)	5A (200)	6A (250)	7A (300)	8A (450)	9A (600)	Exxx (>750)	
 EN ISO 10140	<b>Schalldämmung</b> $R_w$ (C, $C_{tr}$ ) (dB) <b>Isolation phonique</b> $R_w$ (C, $C_{tr}$ ) (dB) <b>Sound insulation</b> $R_w$ (C, $C_{tr}$ ) (dB)	npd	bis $R_w$ 44 dB (-2; -5) jusqu'à $R_w$ 44 dB (-2; -5) up to $R_w$ 44 dB (-2; -5)										
 EN ISO 10077-2	<b>Wärmedurchgangskoeffizient</b> $U_f$ (W/(m <sup>2</sup> ·K)) <b>Transmission thermique</b> $U_f$ (W/(m <sup>2</sup> ·K)) <b>Thermal production</b> $U_f$ (W/(m <sup>2</sup> ·K))	npd	ab 5.65 W/m <sup>2</sup> K à partir de 5.65 W/m <sup>2</sup> K from 5.65 W/m <sup>2</sup> K										
 EN 12207	<b>Luftdurchlässigkeit</b> <b>Perméabilité à l'air</b> <b>Air permeability</b>	npd	1 (150)		2 (300)		3 (600)		4 (600)				
 EN 1192	<b>Klassifizierung der Festigkeitsanforderungen</b> <b>Classification des exigences de résistance méca.</b> <b>Classification of strength requirements</b>	npd	1		2		3		4				
 EN 1627	<b>Einbruchhemmung</b> <b>Anti-effraction</b> <b>Burglar resistance</b>	npd	1		2		3		4		5		6
 EN 1522	<b>Durchschusshemmung</b> <b>Résistance aux balles</b> <b>Bullet proofing</b>	npd	FB1	FB2	FB3	FB4	FB5	FB6	FB7	FSG			
 EN 1191 EN 1603	<b>Dauerfunktionsprüfung</b> <b>Durabilité mécanique</b> <b>Mechanical durability</b>	D	1 5'000	2 10'000	3 20'000	4 50'000	5 100'000	6 200'000	7 500'000	8 1'000'000			
 EN 179 EN 1125	<b>Fähigkeit zur Freigabe</b> <b>Capacité au déclenchement</b> <b>Ability to release</b>		Anforderung erfüllt Exigence remplie Requirement fulfilled										

Norm	Eigenschaft Caractéristique Characteristic	Klassifizierung/Wert Classification / Valeur Classification / Value			
 EN 12217	<b>Bedienkräfte</b> <b>Forces de manœuvre</b> <b>Operating forces</b>	npd	0	1	2
 EN 1634-3 DIN 18095	<b>Rauchschutz</b> <b>Etanchéité à la fumée</b> <b>Smoke control</b>	S <sub>a</sub> / S <sub>200</sub> / RS			
 EN 16034 EN 13501-2	<b>Selbstschliessung</b> <b>Fermeture automatique</b> <b>Self-closing</b>	C			
 EN 16034	<b>Dauerhaftigkeit der Selbstschliessung gegenüber Alterung (Korrosion)</b> <b>Endurance de la fermeture automatique contre le vieillissement (corrosion)</b> <b>Durability of self-closing against ageing (corrosion)</b>	erzielt atteinte achieved			



### Einbruchhemmende Jansen-Economy 60 Türen

- Türflügelgrößen 1465 x 3000 mm
- Ein- und zweiflügelige Türen, nach innen und aussen öffnend
- Geprüft nach EN 1627
- Panik- und Normalausführung

### Portes anti-effraction Jansen-Economy 60

- Dimensions de vantail de porte 1465 x 3000 mm
- Portes à un/deux vantaux à ouverture vers l'intérieur et l'extérieur
- Contrôlé selon la norme EN 1627
- Exécution panique et exécution normale

### Burglar-resistant Jansen Economy 60 doors

- Door leaf sizes 1465 x 3000 mm
- Single and double-leaf doors, inward and outward opening
- Tested in accordance with EN 1627
- Panic and standard design



### Durchschusshemmende Jansen-Economy 60 Türen

- Türflügelgrößen 1465 x 3000 mm
- Ein- und zweiflügelige Türen, nach innen und aussen öffnend
- Geprüft nach EN 1522

### Portes pare-balles Jansen-Economy 60

- Dimensions de vantail de porte 1465 x 3000 mm
- Portes à un/deux vantaux à ouverture vers l'intérieur et l'extérieur
- Contrôlé selon la norme EN 1522

### Bullet-resistant Jansen Economy 60 doors

- Door leaf sizes 1465 x 3000 mm
- Single and double-leaf doors, inward and outward opening
- Tested in accordance with EN 1522



### **Fluchttürsysteme**

- Verschlussystem für Notausgangstüren nach EN 179
- Verschlussystem für Paniktüren nach EN 1125
- Barrierefreie Türen ohne Schwelle für behindertengerechtes Bauen
- Ein- und zweiflügelige Türen nach innen und aussen öffnend
- Türflügelgrößen bis 1465 x 3000 mm und Flügelgewicht bis 230 kg

### **Systèmes de porte de secours**

- Système de fermeture pour portes de secours selon EN 179
- Système de fermeture pour portes panique selon EN 1125
- Portes sans seuil pour faciliter l'accès aux personnes handicapées
- Portes à un/deux vantaux à ouverture vers l'intérieur et l'extérieur
- Dimensions de vantail de porte jusqu'à 1465 x 3000 mm et poids de vantail jusqu'à 230 kg

### **Emergency exit systems**

- Closing system for emergency exit doors in accordance with EN 179
- Closing system for panic doors in accordance with EN 1125
- Barrier-free doors without threshold for accessible buildings
- Single and double-leaf doors, inward and outward opening
- Door leaf sizes up to 1465 x 3000 mm and leaf weight up to 230 kg



### **Jansen-Economy 60 Fingerschutzüren**

- Keine Quetsch- und Scherstellen nach DIN 18650
- Wartungsarme Bandlager unten und oben
- Geeignet für Gebäude mit starkem Publikumsverkehr
- Geprüft nach EN 14351-1

### **Portes anti-pince-doigts Jansen-Economy 60**

- Absence de zones d'écrasement et de cisaillement selon DIN 18650
- Paliers de paumelle inférieur et supérieur exigeant peu de maintenance
- Adapté à des bâtiments publics fortement fréquentés
- Contrôlé selon la norme EN 14351-1

### **Jansen Economy 60 anti-finger-trap doors**

- No crushing and shearing points as per DIN 18650
- Low-maintenance hinge bush at top and bottom
- Suitable for buildings subject to frequent use by the public
- Tested in accordance with EN 14351-1





### Verblechte Jansen-Economy 60 Türen

- Flächenbündig verblechte Türen
- Geschweisst oder geklebt
- Nach innen und aussen öffnend
- Mit Glasausschnitt möglich

### Portes tôlées Jansen-Economy 60

- Portes tôlées à fleur
- Soudées ou collées
- Ouverture vers l'intérieur et l'extérieur
- Panneau de verre possible

### Jansen Economy 60 sheet metal doors

- Flush-fitted sheet metal doors
- Welded or bonded
- Inward and outward-opening
- Can have glass vision panel



### Jansen-Economy 60 faltwand

- Nach innen und aussen öffnend
- Leichtgängige, geräuscharme Bedienung
- Schwellenlose Ausführung
- Flügelgewichte bis 100 kg

### Porte repliable Jansen-Economy 60

- Ouverture vers l'intérieur et l'extérieur
- Mobilité silencieuse
- Exécution sans seuil
- Poids de vantail jusqu'à 100 kg

### Jansen Economy 60 folding wall

- Inward and outward-opening
- Smooth and quiet operation
- Design without a threshold
- Vent weights up to 100 kg

## Jansen Docu Center

Die Plattform zum effizienten Arbeiten mit Jansen Dokumentationen. Im Jansen Docu Center stehen alle Produktinformationen jederzeit digital in der aktuellsten Version zur Verfügung: von Architekten-Informationen über Bestell- und Fertigungskatalogen bis hin zu Anleitungen und Prospekten sowie Videos.

Die Inhalte können einfach und schnell aufgerufen werden. Ein für den Anwender komfortables papierloses Arbeiten, das zahlreiche Vorteile bietet.

## Download CAD Daten

**DXF**

**DWG**

Sie können die Zeichnungen in den Formaten DXF und/oder DWG herunterladen. Klicken Sie auf das entsprechende Icon und der Download erfolgt.

Die Hinweise «Artikelbibliothek/Türbeschläge/Fensterbeschläge» bedeuten, dass Sie mit einem Klick die gesamte Artikelbibliothek des entsprechenden Systems herunterladen (Profile, Beschläge, Glasleisten, Zubehör etc.).

## Info und Beratung

Gerne beraten wir Sie persönlich und stehen Ihnen bei Fragen zur Verfügung. Bitte schreiben Sie uns Ihre Anliegen an: [info@jansen.com](mailto:info@jansen.com)

## Jansen Docu Center

La plate-forme pour travailler efficacement avec les documentations Jansen. Le Jansen Docu Center met à votre disposition les informations sur les produits, en format numérique et dans une version actualisée: des catalogues de commande et de fabrication aux instructions et prospectus, en passant par les informations destinées aux architectes et vidéos.

Les contenus sont facilement et rapidement accessibles. Une manière de travailler confortable et offrant de nombreux avantages.

## Télécharger fichiers DAO

**DXF**

**DWG**

Vous pouvez télécharger les dessins aux formats DXF et/ou DWG. Cliquez sur l'icône correspondante et le téléchargement s'effectuera.

Les indications «Bibliothèque des articles/Ferures de porte/Ferrures de fenêtres» signifie que vous téléchargez la totalité de la bibliothèque des articles du système donné (profilés, ferrures, parclozes, accessoires etc.).

## Info et conseils

Nous vous conseillerons volontiers individuellement et sommes à votre disposition si vous avez des questions à poser. Veuillez nous envoyer votre requête à: [info@jansen.com](mailto:info@jansen.com)

## Jansen Docu Center

The platform for working efficiently with Jansen documentation. The latest version of all the product information is available digitally at any time in the Jansen Docu Center – from order and fabrication manuals to architect information, instructions and brochures and videos.

The content can be retrieved quickly and easily. The user can work conveniently without paper, which has numerous benefits.

## Download CAD files

**DXF**

**DWG**

You can download the drawings in DXF and/or DWG format. Click on the relevant icon to begin the download.

The items «Article library/Door fittings/Window fittings» means that you download the entire article library for the corresponding system with one click (profiles, fittings, glazing beads, accessories etc.).

## Information and advice

We would be delighted to provide you with advice in person and are available to answer any questions you may have. Please write to us with your queries at: [info@jansen.com](mailto:info@jansen.com)

Zulassungen/Prüfungen  
Homologations/Essais  
Authorisations/Tests

Jansen-Economy 60 Türen  
Jansen-Economy 60 portes  
Jansen-Economy 60 doors

Elementgrößen  
(Empfehlung für CE-Kennzeichnung)

Dimensions des éléments  
(Recommandation pour le label CE)

Size of elements  
(Recommendation for CE marking)

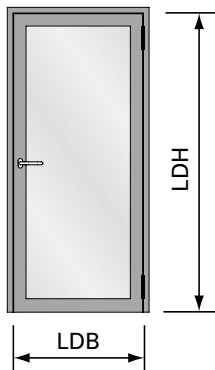

LDB Lichte Durchgangsbreite  
max. 1400 mm  
min. 490 mm

LDB Largeur vide lumière  
max. 1400 mm  
min. 490 mm

LDB Clear opening width  
max. 1400 mm  
min. 490 mm

LDH Lichte Durchgangshöhe  
max. 3000 mm  
min. 1900 mm

LDH Hauteur vide lumière  
max. 3000 mm  
min. 1900 mm

LDH Clear opening height  
max. 3000 mm  
min. 1900 mm

Flügelgewicht max. 230 kg

Poids de vantail max. 230 kg

Weight of leaf max. 230 kg

Zulassungen/Prüfungen  
Homologations/Essais  
Authorisations/Tests

Jansen-Economy 60 Türen  
Jansen-Economy 60 portes  
Jansen-Economy 60 doors

Elementgrößen  
(Empfehlung für CE-Kennzeichnung)

Dimensions des éléments  
(Recommandation pour le label CE)

Size of elements  
(Recommendation for CE marking)

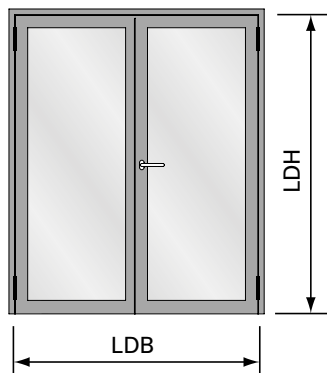

LDB Lichte Durchgangsbreite  
max. 2800 mm  
min. 1000 mm

LDB Largeur vide lumière  
max. 2800 mm  
min. 1200 mm

LDB Clear opening width  
max. 2800 mm  
min. 1000 mm

LDH Lichte Durchgangshöhe  
max. 3000 mm  
min. 1900 mm

LDH Hauteur vide lumière  
max. 3000 mm  
min. 1900 mm

LDH Clear opening height  
max. 3000 mm  
min. 1900 mm

Flügelgewicht max. 230 kg

Poids de vantail max. 230 kg

Weight of leaf max. 230 kg

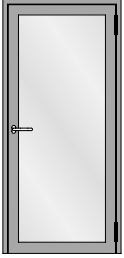

Einflügelige Türe  
Porte à un vantail  
Single leaf door

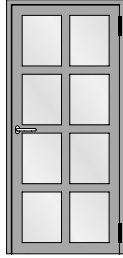

Einflügelige Türe mit Riegel  
Porte à un vantail avec traverse  
Single leaf door with transom

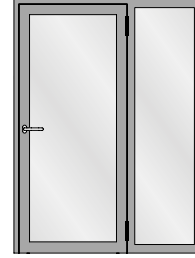

Einflügelige Türe mit Seitenteil  
Porte à un vantail avec partie latérale  
Single leaf door with side light

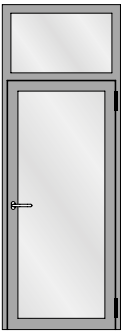

Einflügelige Türe mit Oberlicht  
Porte à un vantail avec imposte  
Single leaf door with top light

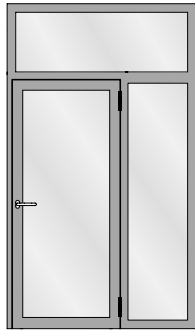

Einflügelige Türe mit Seitenteil und Oberlicht  
Porte à un vantail avec avec partie latérale  
et imposte  
Single leaf door with side light and top light

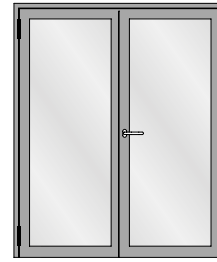

Zweiflügelige Türe  
Porte à deux vantaux  
Double leaf door



Zweiflügelige Türe mit zwei Seitenteilen  
Porte à deux vantaux avec deux parties latérales  
Double leaf door with two side lights

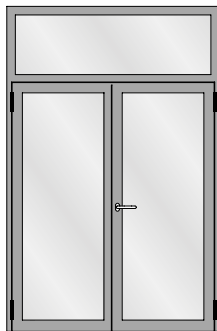

Zweiflügelige Türe mit Oberlicht  
Porte à deux vantaux avec imposte  
Double leaf door with top light

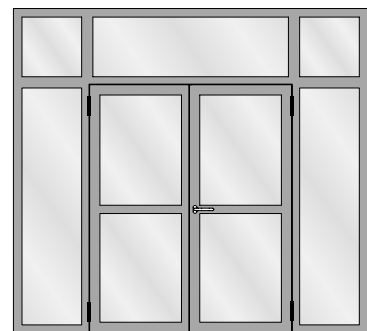

Zweiflügelige Türe mit zwei Seitenteilen und Oberlichtern  
Porte à deux vantaux avec deux parties latérales et impostes  
Double leaf door with two side lights and top lights

**Typenübersicht**  
**Sommaire des types**  
**Summary of types**

**Jansen-Economy 60 Türen**  
**Jansen-Economy 60 portes**  
**Jansen-Economy 60 doors**

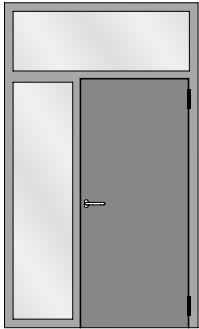

Verblechte Türe mit Seitenteil und Oberlicht  
Porte tôlée à un vantail avec avec partie latérale  
et imposte  
Sheet metal single leaf door with side light  
and top light



Verblechte zweiflügelige Türe mit zwei  
Seitenteilen und Oberlichtern  
Porte tôlée à deux vantaux avec deux parties  
latérales et impostes  
Sheet metal double leaf door with two side  
lights and top lights



Festverglasung  
Vitrage fixe  
Fixed glazing

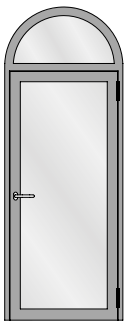

Einflügelige Türe mit Rundbogen-Oberlicht  
Porte à un vantail avec imposte demi-ronde  
Single leaf door with round arched top light

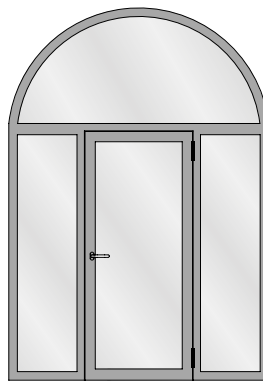

Einflügelige Türe mit zwei Seitenteilen und  
Rundbogen-Oberlicht  
Porte à un vantail avec deux parties latérales  
et imposte demi-ronde  
Single leaf door with two side lights and  
round arched top light

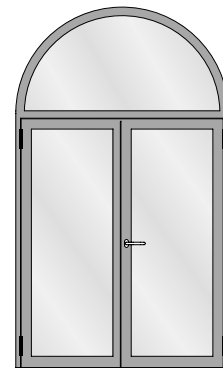

Zweiflügelige Türe mit Rundbogen-Oberlicht  
Porte à deux vantaux avec imposte demi-ronde  
Double leaf door with round arched top light

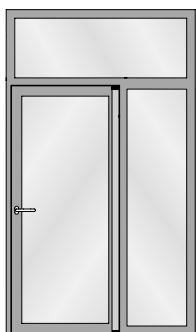

Fingerschutztüre  
Porte anti-pince-doigts  
Anti-finger-trap door

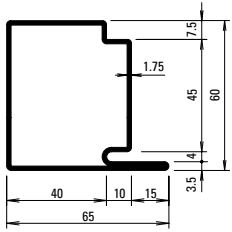

**30.019**  
**30.019 Z**

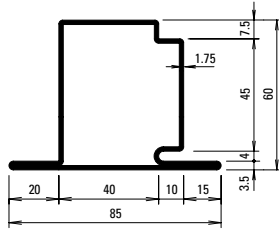

**30.119**  
**30.119 Z**

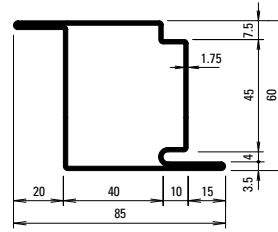

**30.419**  
**30.419 Z**

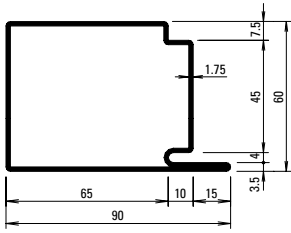

**30.017**  
**30.017 Z**

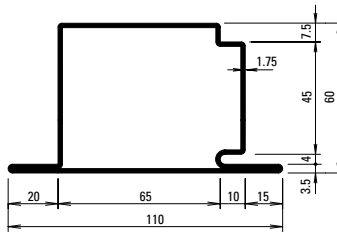

**30.117**  
**30.117 Z**

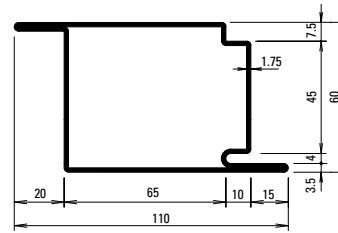

**30.415**

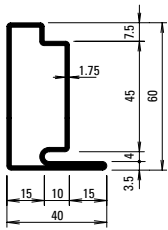

**30.018**  
**30.018 Z**

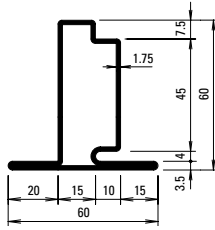

**30.118**  
**30.118 Z**

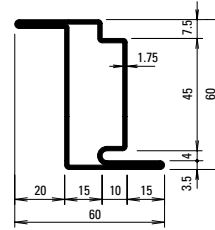

**30.418**  
**30.418 Z**

**Oberfläche/Werkstoff**

Artikel-Nr.

**ohne Zusatz** = blank

**mit Z** = bandverzinkter Stahl

**Surface/Matériau**

No. d'article

**sans supplément** = brut

**avec Z** = bande d'acier zinguée

**Surface/Material**

Part no.

**without addition** = bright

**with Z** = strip galvanised steel

Profil-Nr.	G kg/m	F cm <sup>2</sup>	I <sub>x</sub> cm <sup>4</sup>	W <sub>x</sub> cm <sup>3</sup>	I <sub>y</sub> cm <sup>4</sup>	W <sub>y</sub> cm <sup>3</sup>	U m <sup>2</sup> /m
<b>30.017</b>	4,200	5,36	31,32	9,09	48,57	10,35	0,312
<b>30.018</b>	2,830	3,61	15,95	4,35	4,77	1,93	0,212
<b>30.019</b>	3,520	4,48	23,69	6,70	19,75	5,55	0,262
<b>30.117</b>	4,750	6,04	34,75	9,35	65,74	11,51	0,350
<b>30.118</b>	3,370	4,29	18,64	4,65	8,26	2,75	0,250
<b>30.119</b>	4,050	5,16	26,80	6,99	29,12	6,58	0,300

Profil-Nr.	G kg/m	F cm <sup>2</sup>	I <sub>x</sub> cm <sup>4</sup>	W <sub>x</sub> cm <sup>3</sup>	I <sub>y</sub> cm <sup>4</sup>	W <sub>y</sub> cm <sup>3</sup>	U m <sup>2</sup> /m
<b>30.415</b>	4,750	6,04	37,79	12,28	65,74	11,51	0,350
<b>30.418</b>	3,370	4,29	22,92	7,37	8,62	2,75	0,250
<b>30.419</b>	4,050	5,16	30,36	9,82	29,12	6,58	0,300

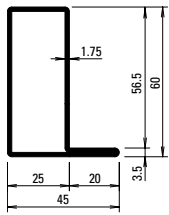

**01.634**  
**01.634 Z**

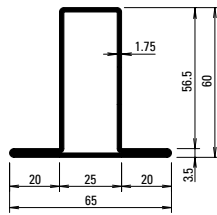

**02.634**  
**02.634 Z**

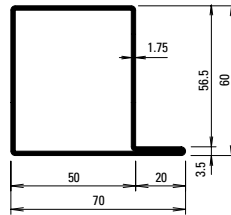

**01.684**  
**01.684 Z**

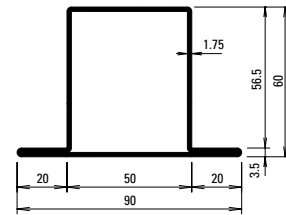

**02.684**  
**02.684 Z**

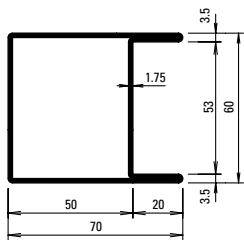

**04.637**  
**04.637 Z**

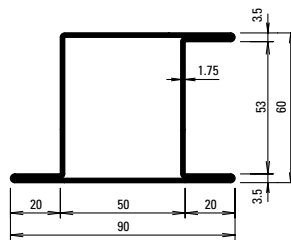

**05.637**  
**05.637 Z**

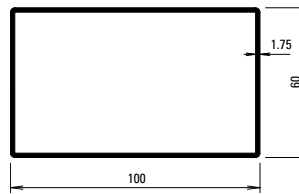

**400.051**  
**400.051 Z**

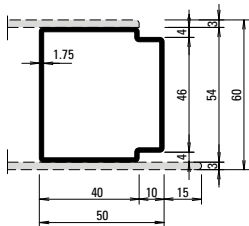

**81.010 Z**

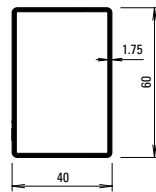

**400.052**  
**400.052 Z**

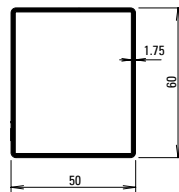

**400.054**  
**400.054 Z**

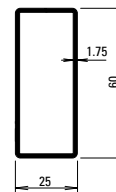

**400.055**  
**400.055 Z**

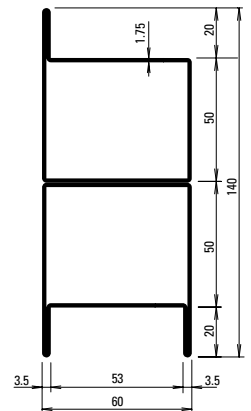

**05.001**

Profil-Nr.	G kg/m	F cm <sup>2</sup>	I <sub>x</sub> cm <sup>4</sup>	W <sub>x</sub> cm <sup>3</sup>	I <sub>y</sub> cm <sup>4</sup>	W <sub>y</sub> cm <sup>3</sup>	U m <sup>2</sup> /m
<b>01.634</b>	2,730	3,48	16,71	4,71	6,04	2,15	0,204
<b>02.634</b>	3,270	4,17	19,66	5,01	10,34	3,18	0,243
<b>01.684</b>	3,430	4,37	24,34	7,07	22,12	5,59	0,255
<b>02.684</b>	3,960	5,05	27,70	7,36	31,93	7,09	0,294
<b>04.637</b>	3,960	5,05	30,62	10,2	27,45	7,71	0,294
<b>05.637</b>	4,500	5,72	35,42	10,6	39,45	8,02	0,333
<b>81.010</b>	2,700	3,43	14,53	5,38	13,05	5,10	0,202
<b>400.051</b>	4,300	5,44	76,01	15,2	34,64	11,55	0,316
<b>400.052</b>	2,630	3,34	8,98	4,49	16,86	5,62	0,197
<b>400.054</b>	2,900	3,69	14,97	5,98	19,83	6,61	0,217
<b>400.055</b>	2,210	2,82	3,08	2,47	12,41	4,13	0,167

**Stabachse**  
**Axe de la barre**  
**Bar axis**

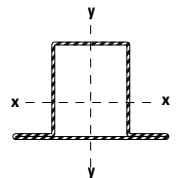

Artikelbibliothek  
 Bibliothèque des articles  
 Article library

**DXF** **DWG**



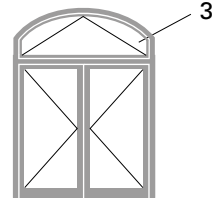
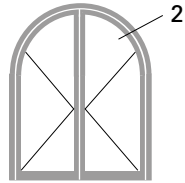
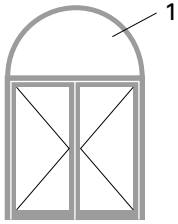

**1.0**

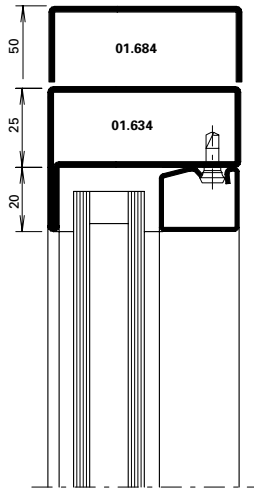

**2.0**

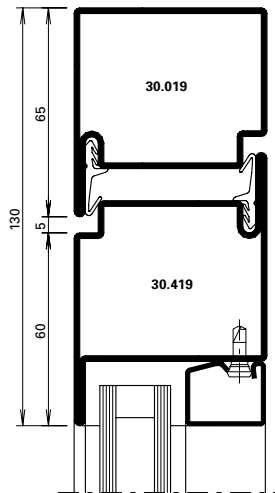

**3.0**

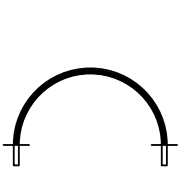
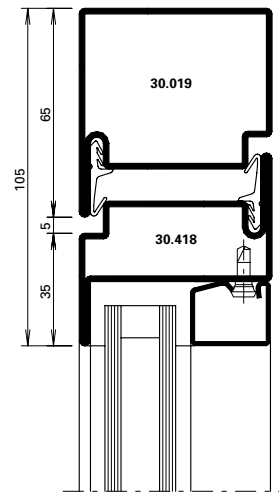

Halbrundbogen  
 Arc semi-circulaire  
 Semi-circular arch

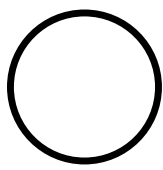

Rundbogen  
 Arc en plein centre  
 Round arch

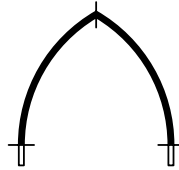

Spitzbogen  
 Ogive  
 Gothic arch



Stichbogen  
 Arc bombé  
 Segmented arch



Korbbogen  
 Anse de panier  
 Oval arch

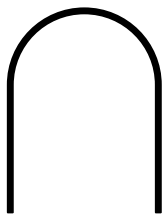

Halbrundbogen mit Schenkel  
 Arc surhaussé  
 Semi-circular arch with side extension

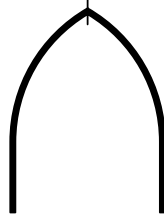

Spitzbogen mit Schenkel  
 Arc en ogive  
 Gothic arch with side extension

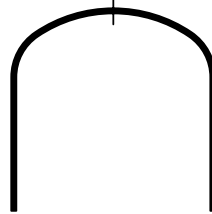



Korbbogen mit Schenkel  
 Anse de panier prolongée  
 Oval arch with side extension

**Bogentüren**  
**Portes cintrées**  
**Arched doors**

**Jansen-Economy 60 Türen**  
**Jansen-Economy 60 portes**  
**Jansen-Economy 60 doors**

Profil Profilé Profile	Min. Radius Rayon min. Min. radius R	
------------------------------	---	--

	blank brut bright	verzinkt zinguée galvanised
	mm	mm
01.634	550	550
01.684	650	650

		
02.634	600	650
02.684	1050	1050

		
04.637	1550	1550

		
05.637	1550	1550

		
400.052	1100	1100
400.054	1000	1000
400.055	800	800
81.010		800

Profil Profilé Profile	Min. Radius Rayon min. Min. radius R	
------------------------------	---	--

	blank brut bright	verzinkt zinguée galvanised
	mm	mm
30.018		550
30.019	650	650

		
30.118	800	800
30.119	900	900

		
30.418	800	800
30.419	1100	1100

Stahl-Glasleisten Parcloses en acier Steel glazing beads	Min. Radius Rayon min. Min. radius R
--	---

	
62.507 Z	300 mm
62.508 Z	300 mm
62.509 Z	300 mm

Stahl-Glasleisten Parcloses en acier Steel glazing beads	Min. Radius Rayon min. Min. radius R
--	---

	
402.112 Z	500 mm
402.115 Z	500 mm
402.120 Z	600 mm
402.125 Z	750 mm
402.130 Z	1000 mm
402.135 Z	1500 mm

Aluminium-Glasleisten Parcloses en aluminium Aluminium glazing beads	Min. Radius Rayon min. Min. radius R
--	---

	
404.109	400 mm
404.112	400 mm
404.115	400 mm
404.120	400 mm
404.125	450 mm
404.130	500 mm
404.135	600 mm

	
405.110	500 mm
405.115	500 mm
405.120	500 mm
405.125	800 mm
405.130	1000 mm
406.903	500 mm
406.905	500 mm
406.907	500 mm
406.909	600 mm

Die Radien-Angaben beziehen sich auf die langjährige Erfahrung und Fertigung im Hause Jansen.

Les rayons indiqués se fondent sur la longue expérience et la fabrication au sein de la maison Jansen.

The radii specifications are based on the many years of experience Jansen has in fabrication.

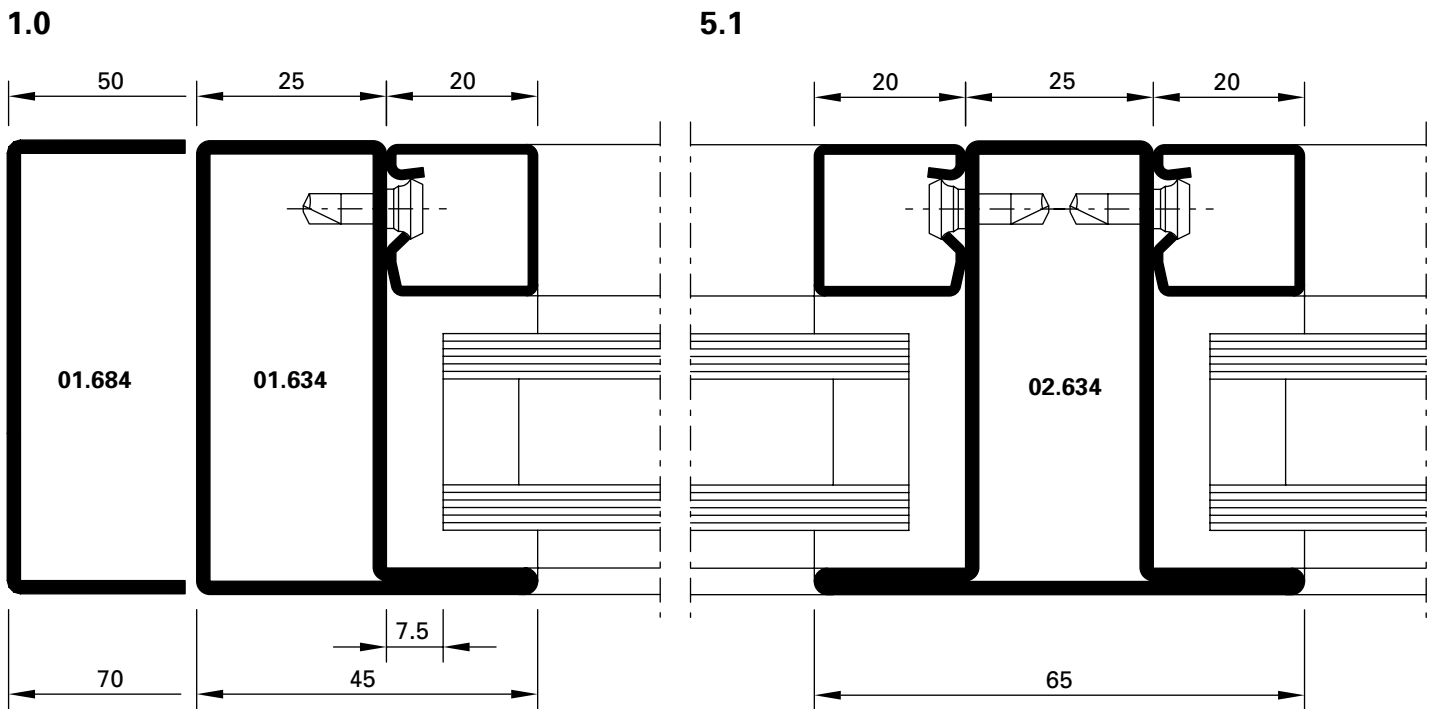
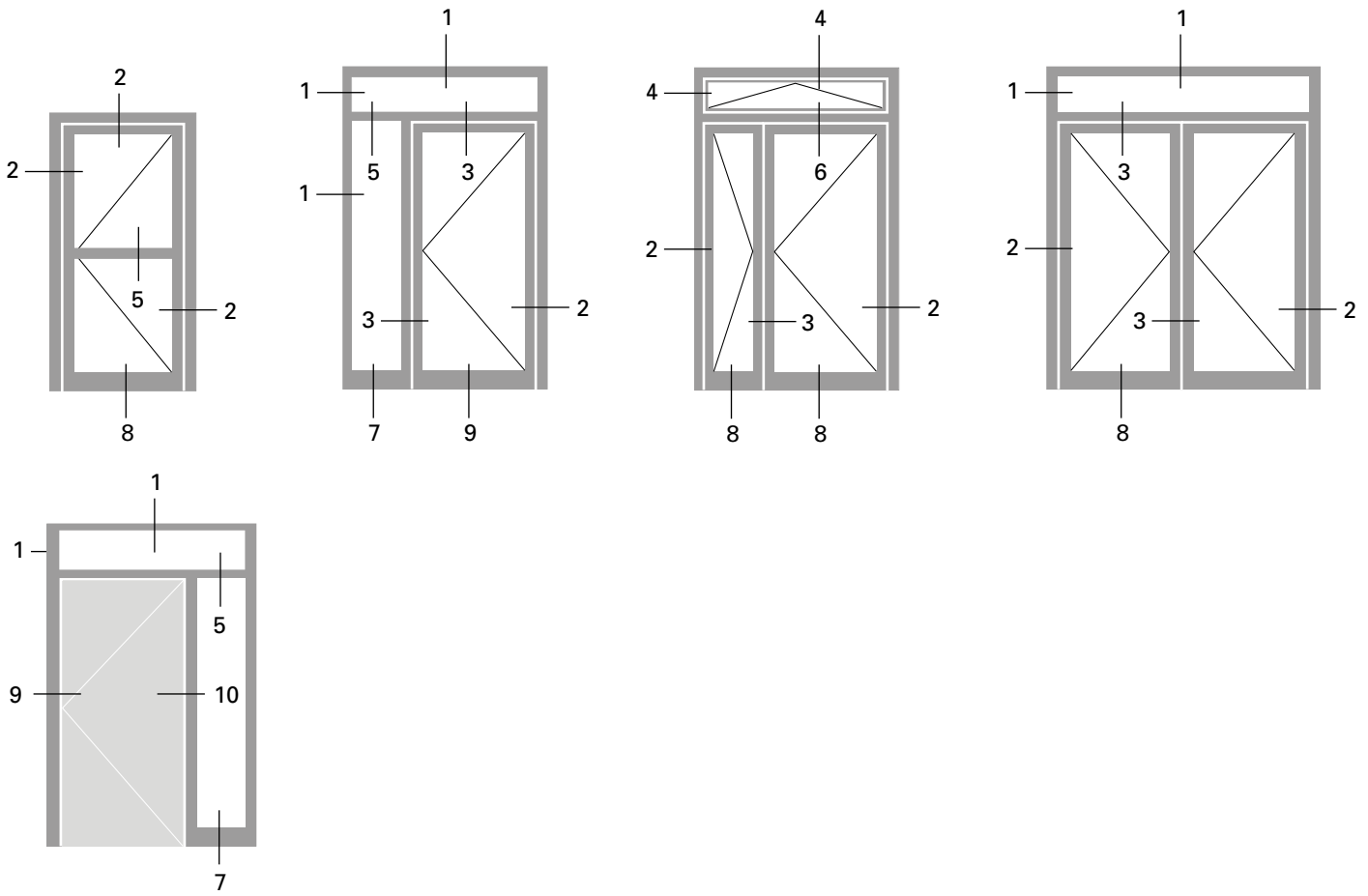

DXF DWG D-250-C-001

DXF DWG D-250-C-032

2.0

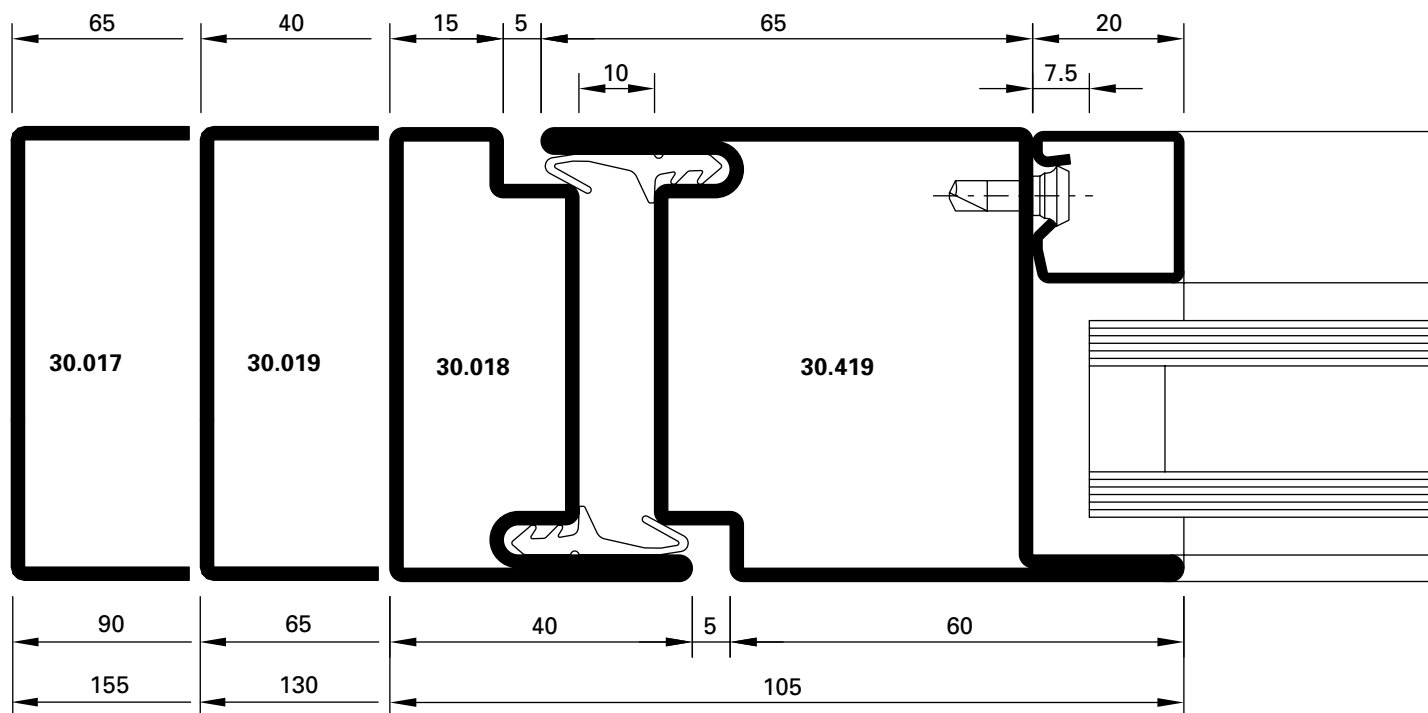

**DXF** **DWG** D-250-C-002

2.2

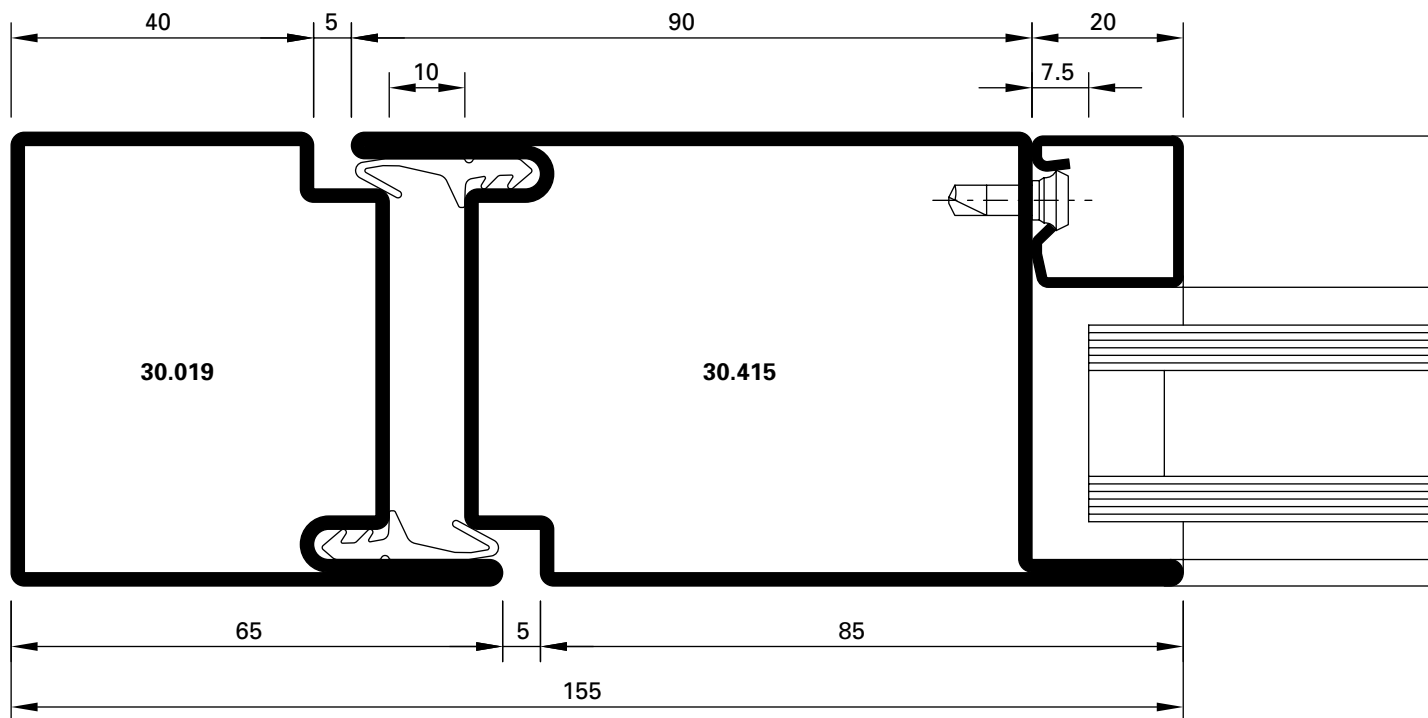

**DXF** **DWG** D-250-C-005

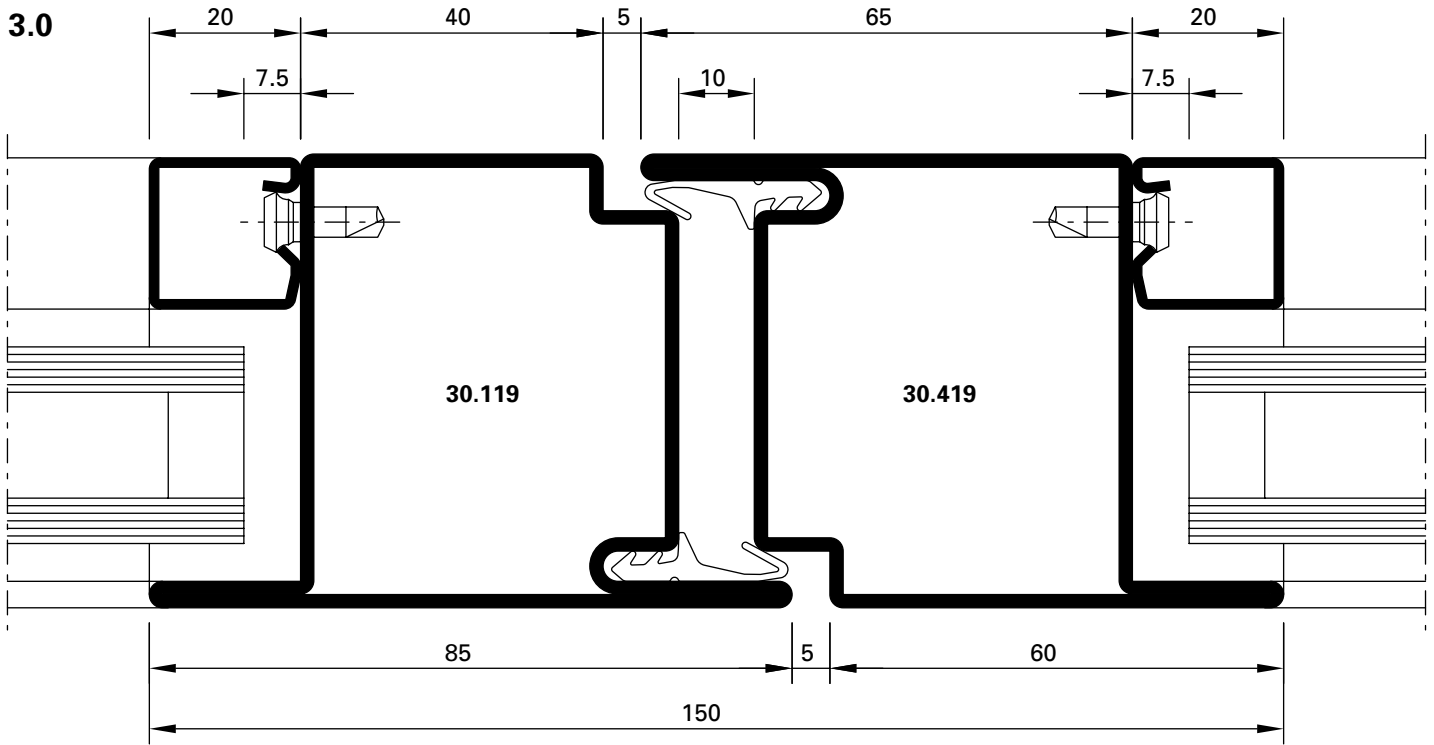

DXF DWG D-250-C-003

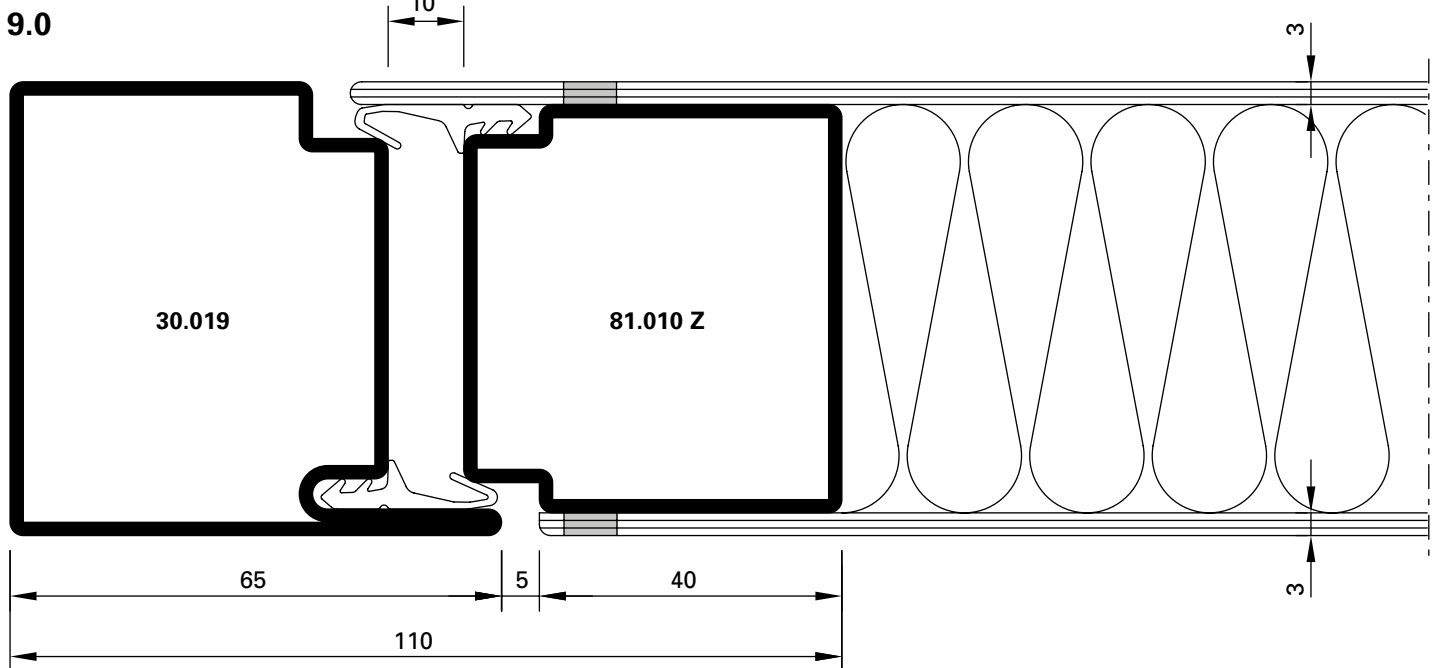

DXF DWG D-250-C-013

4.0

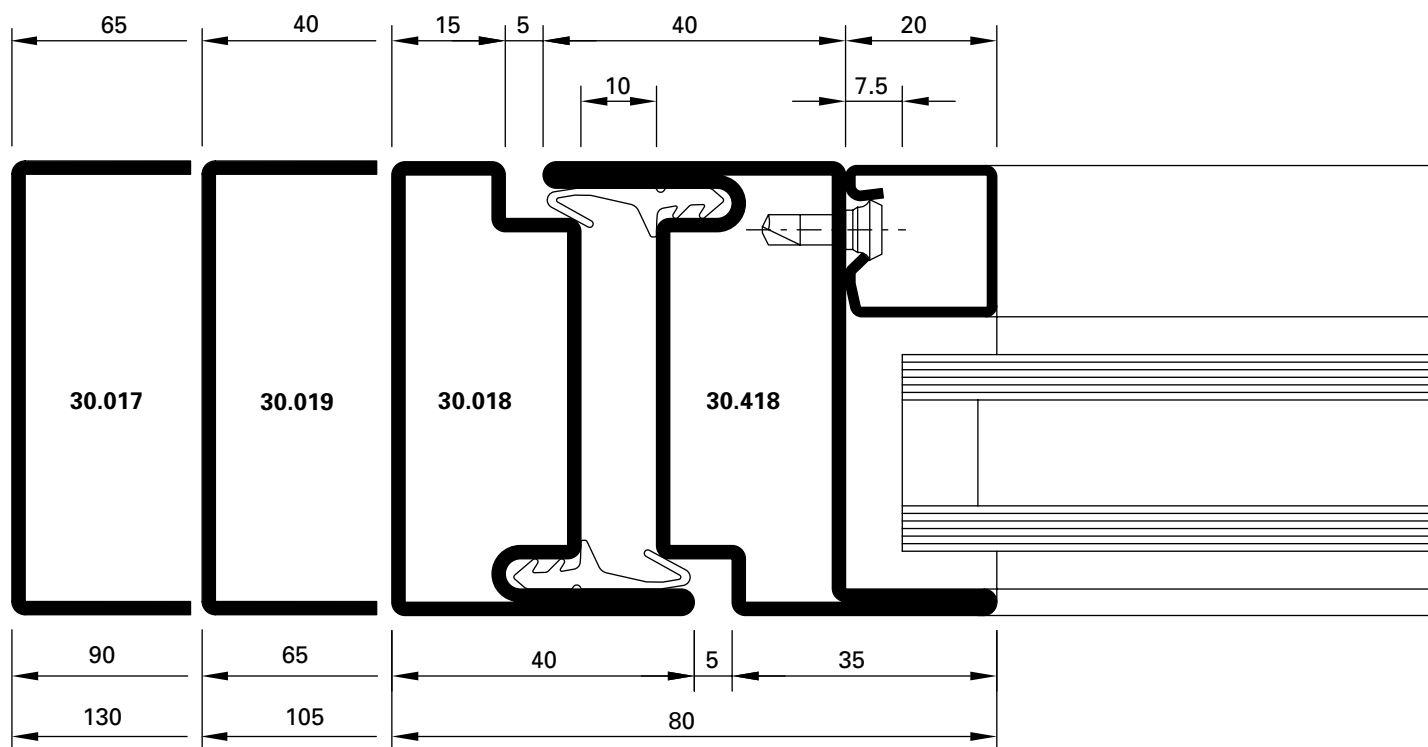

**DXF** **DWG** D-250-C-010

5.0

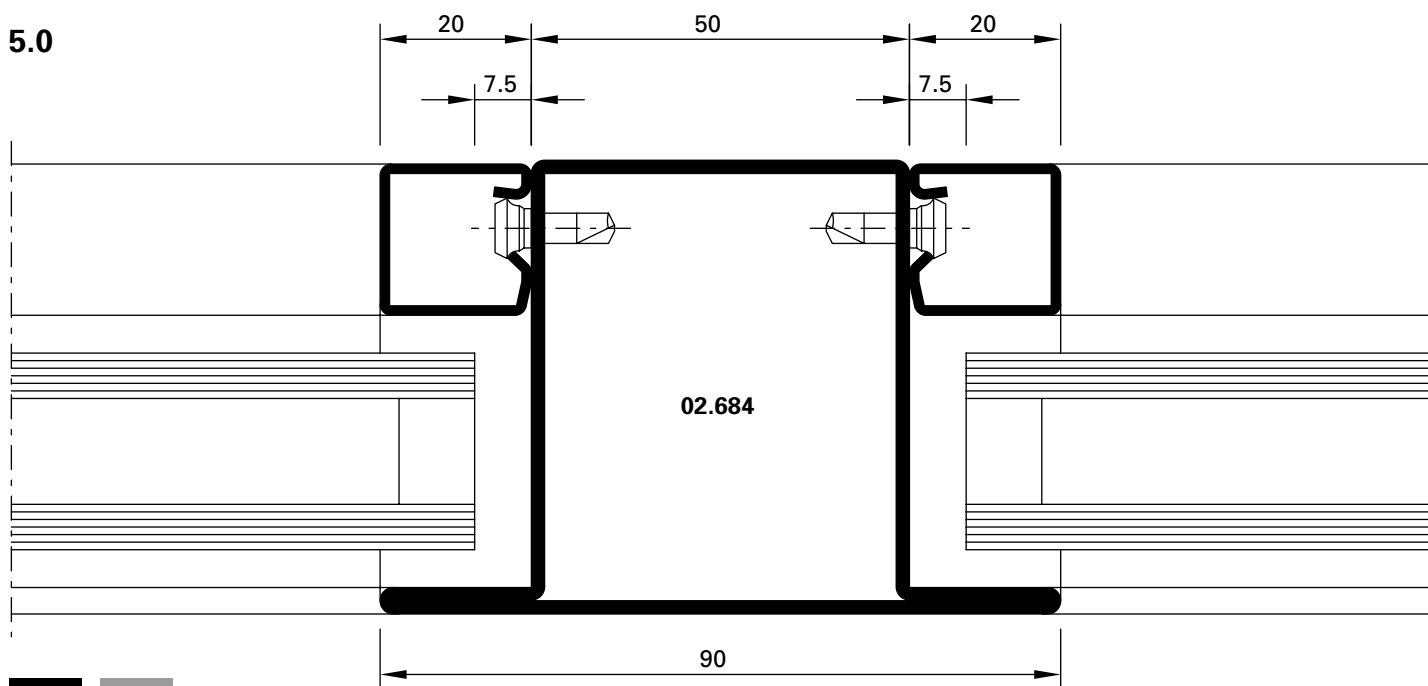

**DXF** **DWG** D-250-C-012

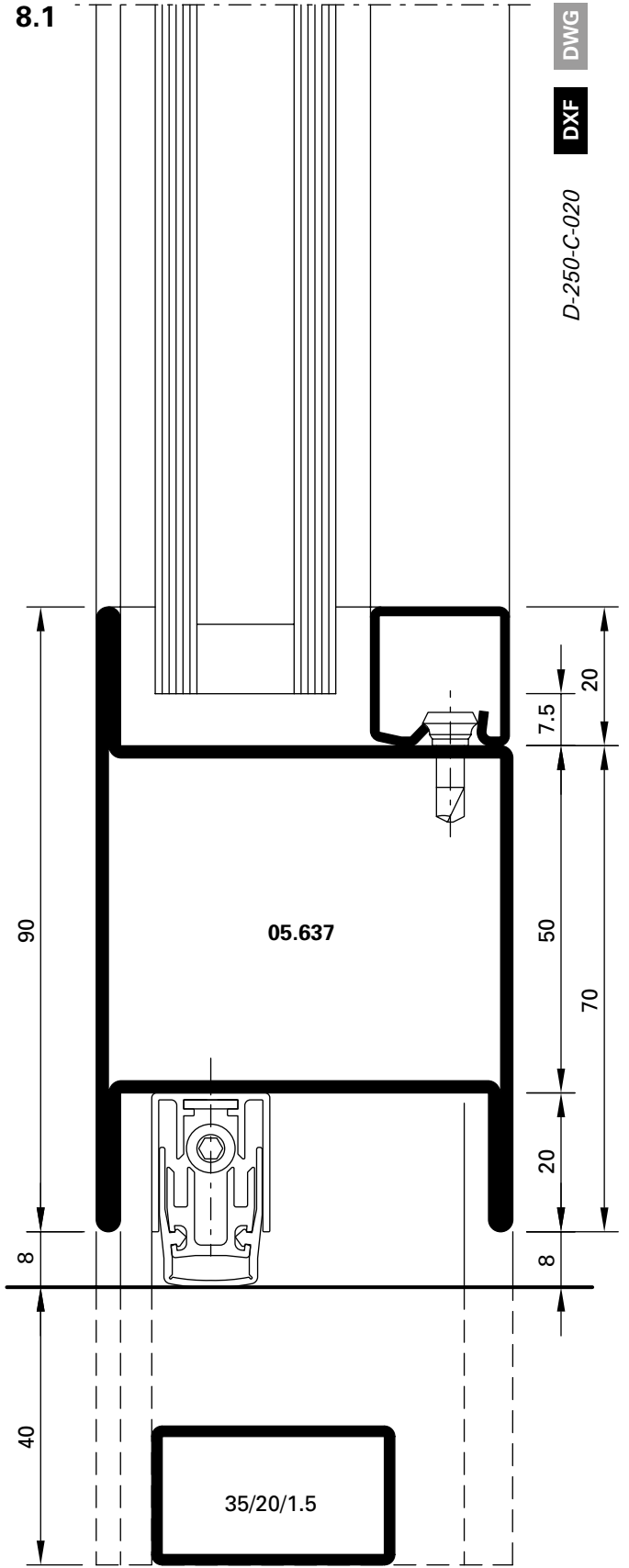
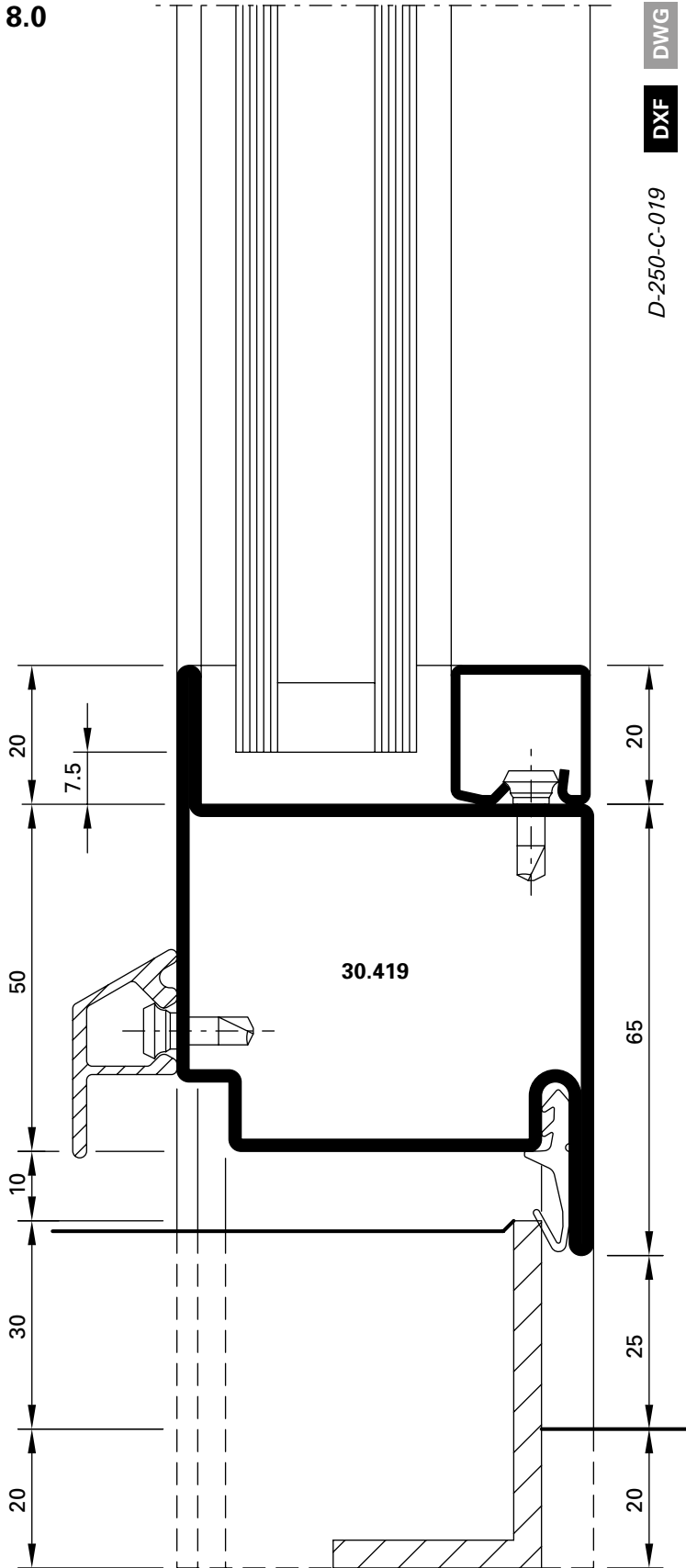

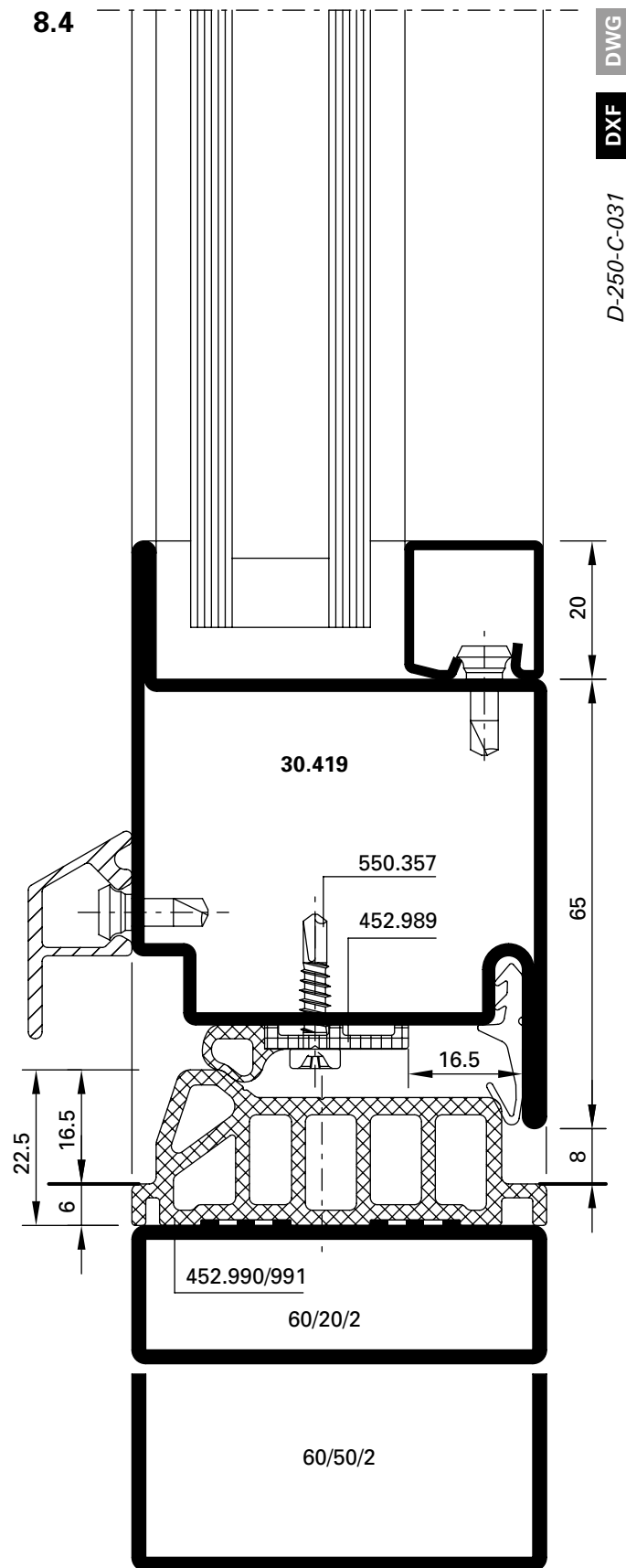
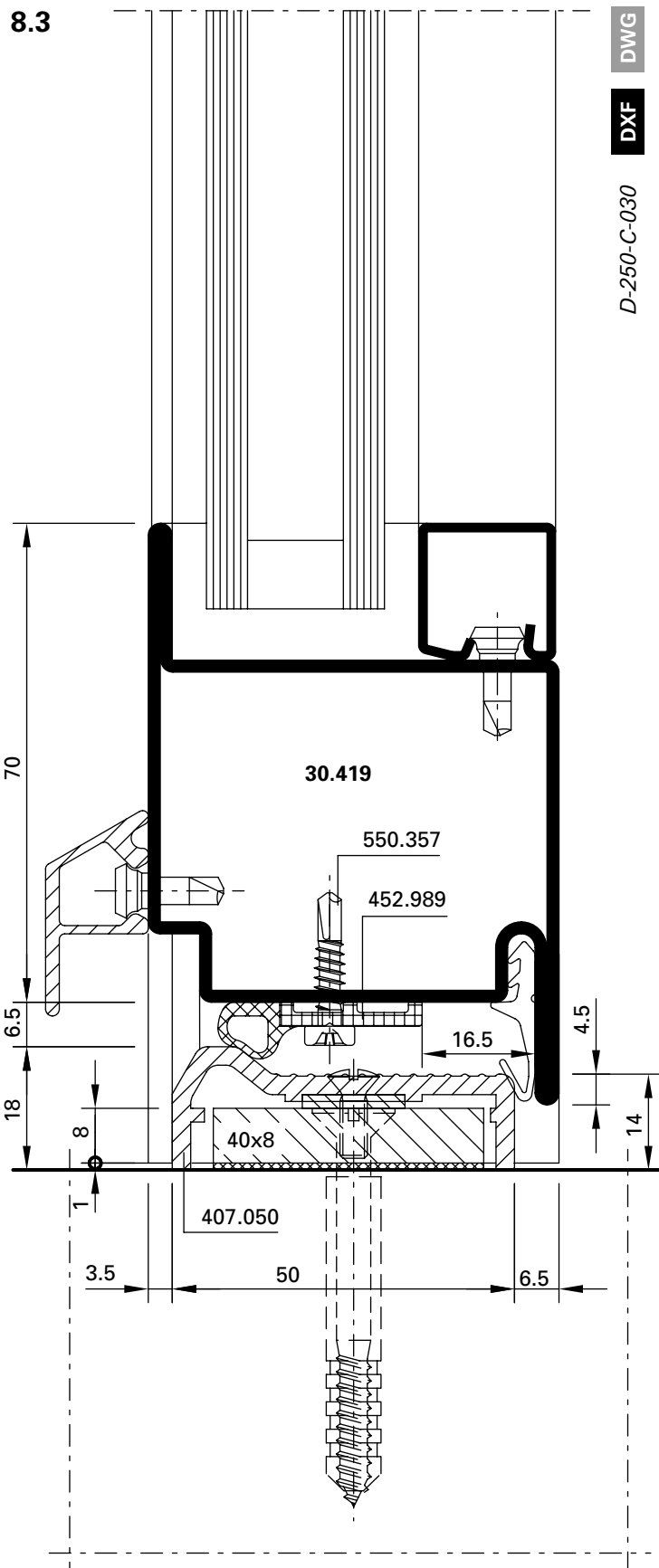



2.1

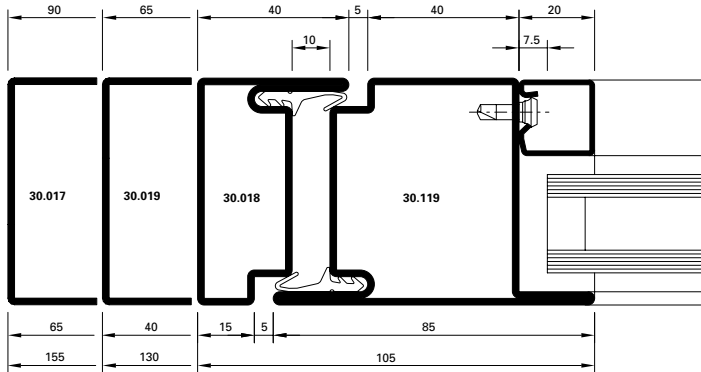

**DXF** **DWG** *D-250-C-004*

2.3

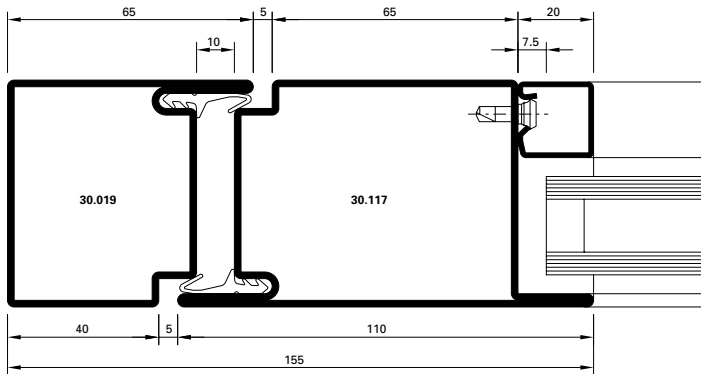

**DXF** **DWG** *D-250-C-006*

3.1

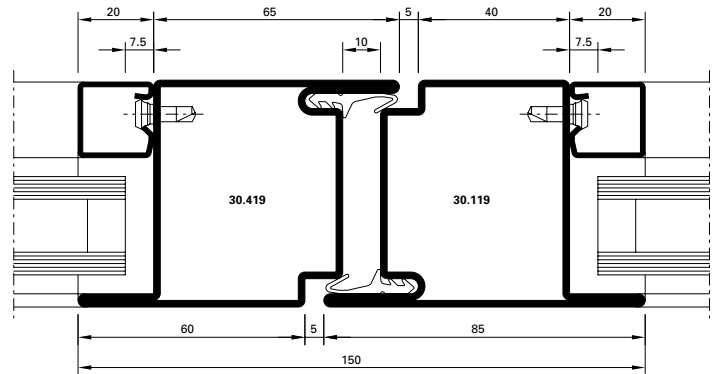

**DXF** **DWG** *D-250-C-007*

3.2

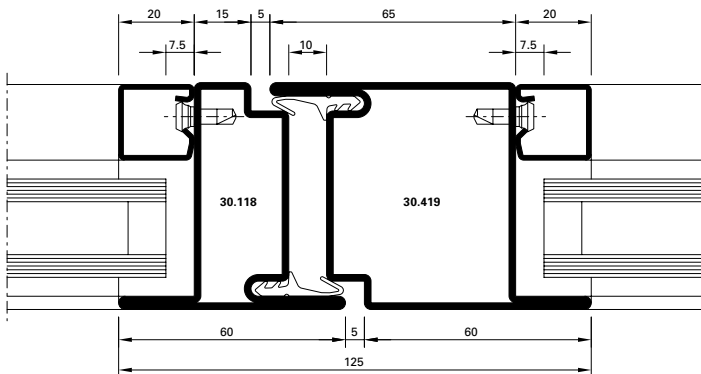

**DXF** **DWG** *D-250-C-008*

3.3

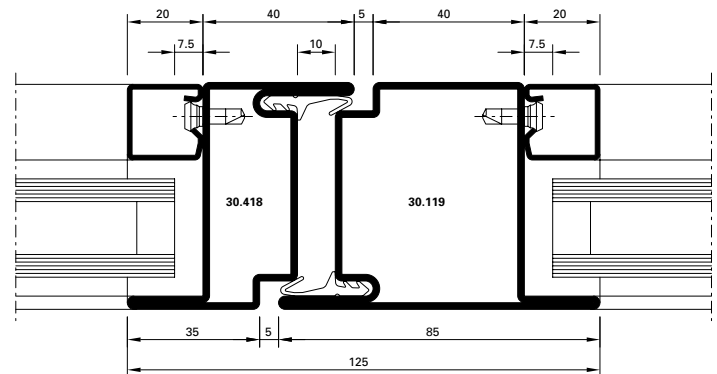

**DXF** **DWG** *D-250-C-009*

9.1

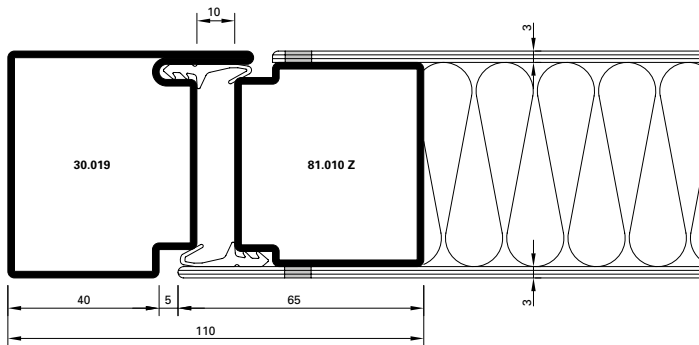

**DXF** **DWG** D-250-C-014

10.0

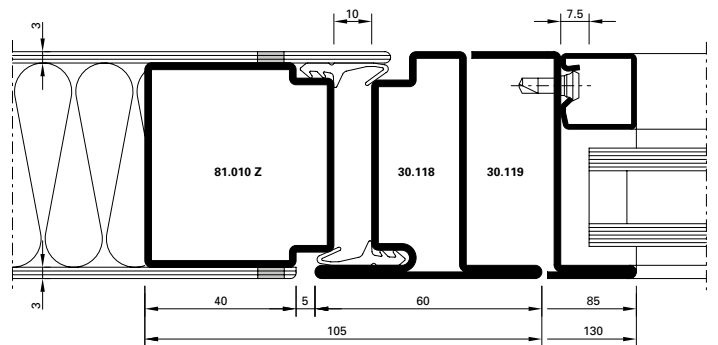

**DXF** **DWG** D-250-C-015

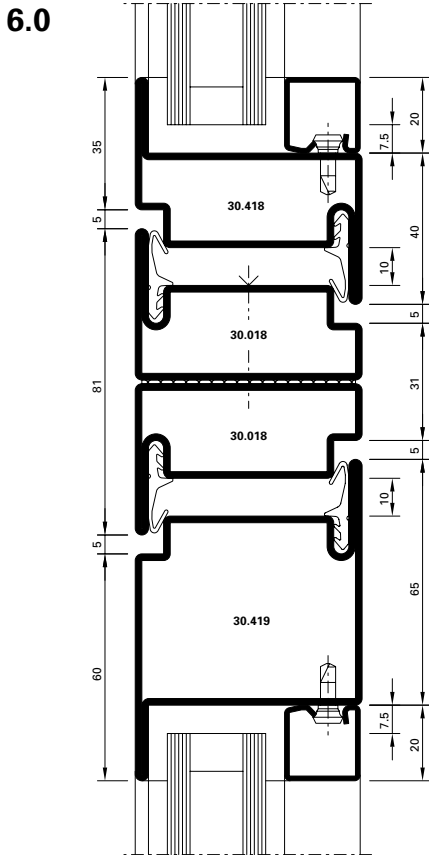

DWG  
DXF  
D-250-C-016

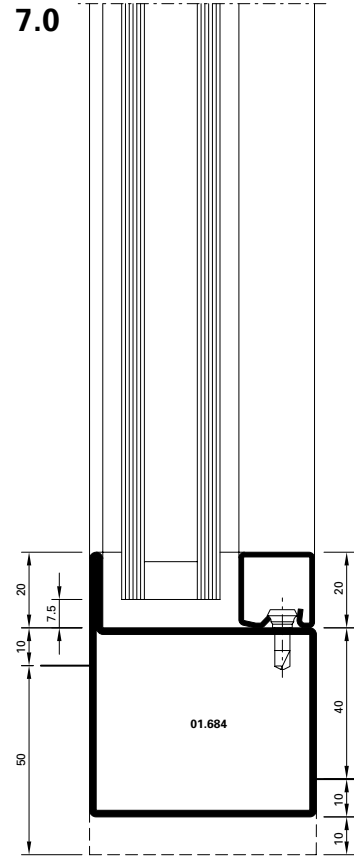

DWG  
DXF  
D-250-C-017

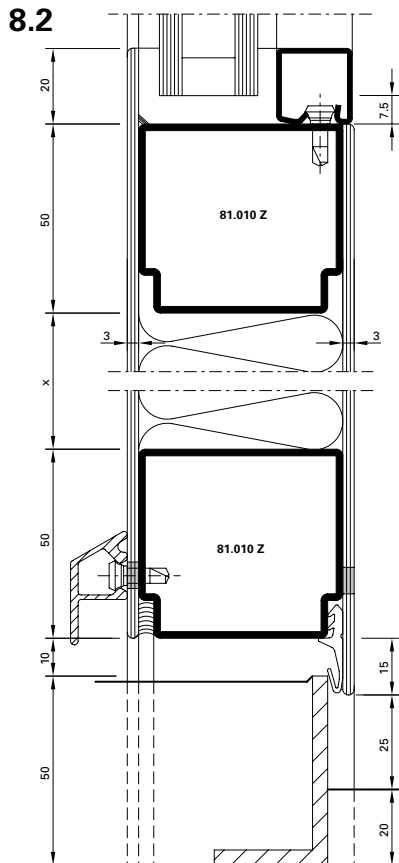

DWG  
DXF  
D-250-C-021

5.1

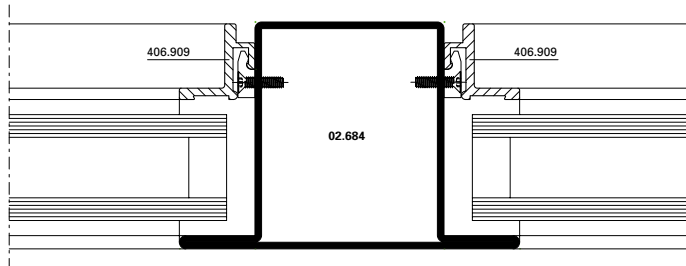

**DXF** **DWG** *D-250-C-022*

5.2

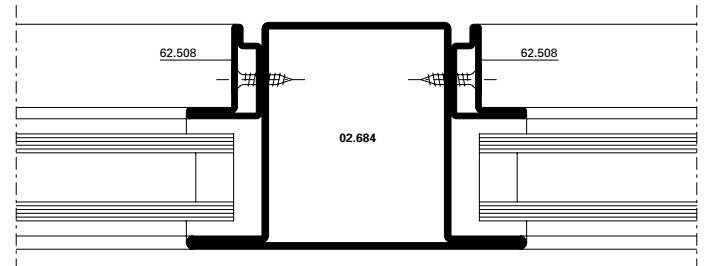

**DXF** **DWG** *D-250-C-023*

5.3

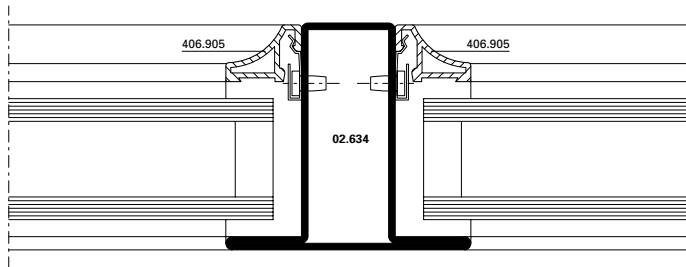

**DXF** **DWG** *D-250-C-024*

5.4

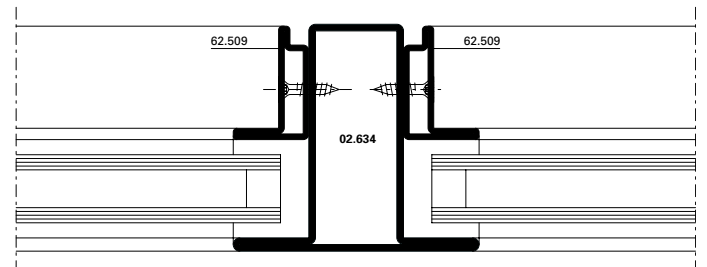

**DXF** **DWG** *D-250-C-025*

5.5

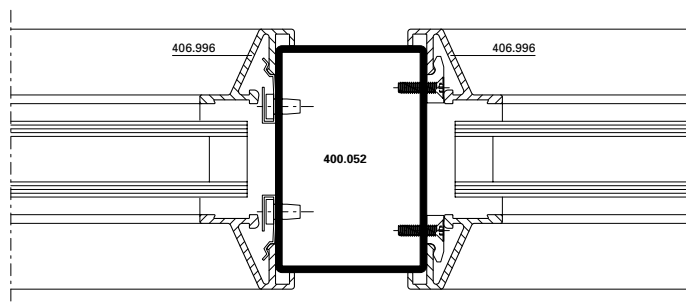

**DXF** **DWG** *D-250-C-026*

5.6

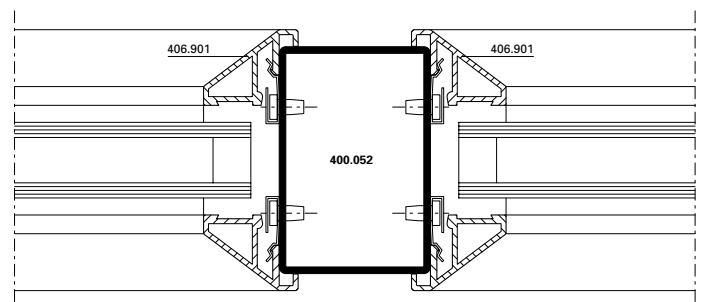

**DXF** **DWG** *D-250-C-027*

5.7

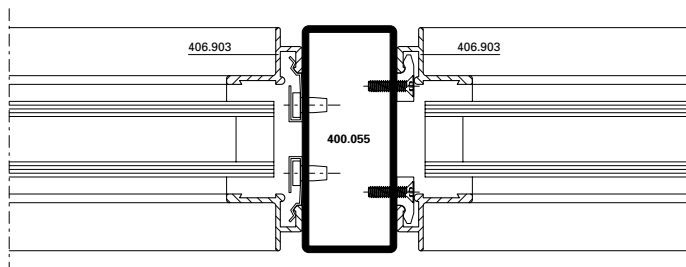

**DXF** **DWG** *D-250-C-028*

5.8

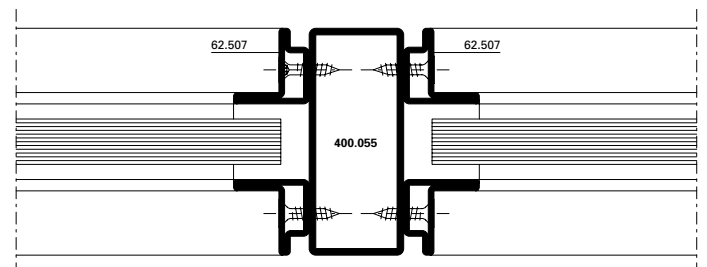

**DXF** **DWG** *D-250-C-029*

**Schnittpunkte im Massstab 1:1**  
**Coupe de détails à l'échelle 1:1**  
**Section details on scale 1:1**

**Jansen-Economy 60 Türen**  
**Jansen-Economy 60 portes**  
**Jansen-Economy 60 doors**

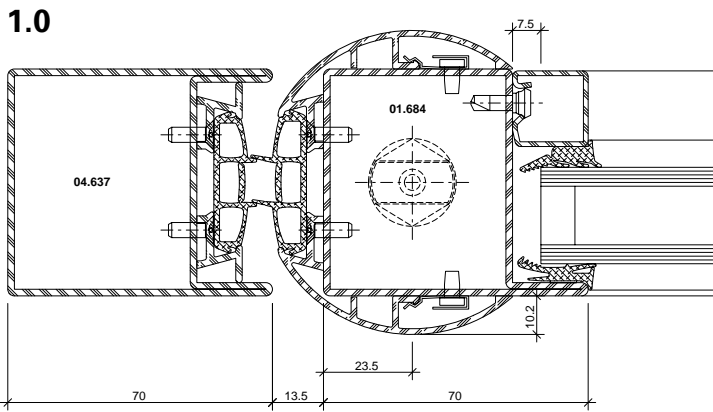
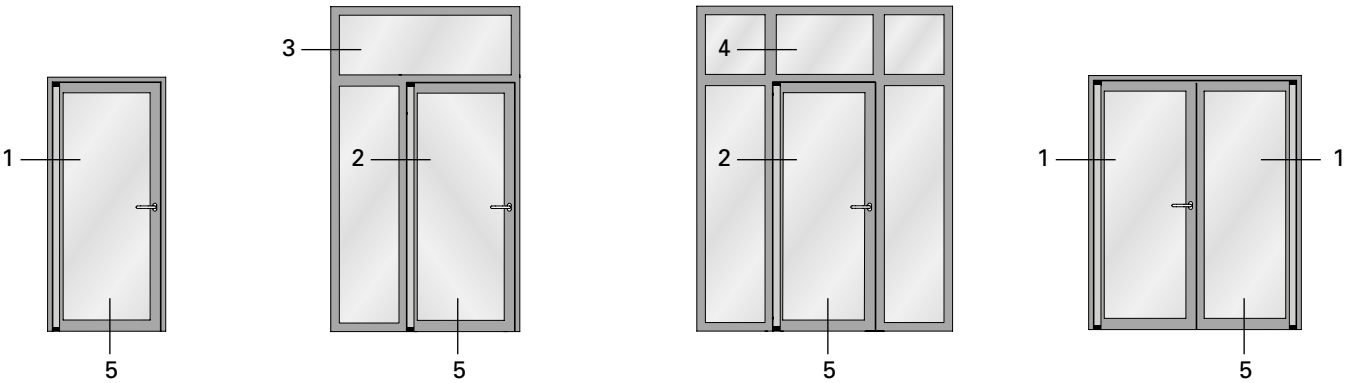

**DXF** **DWG** 22-0103-C-001

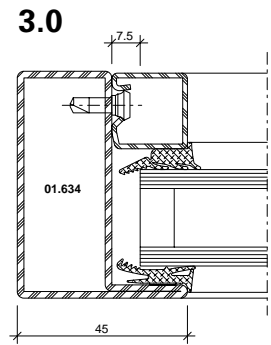

22-0101-C-001  
**DXF** **DWG**

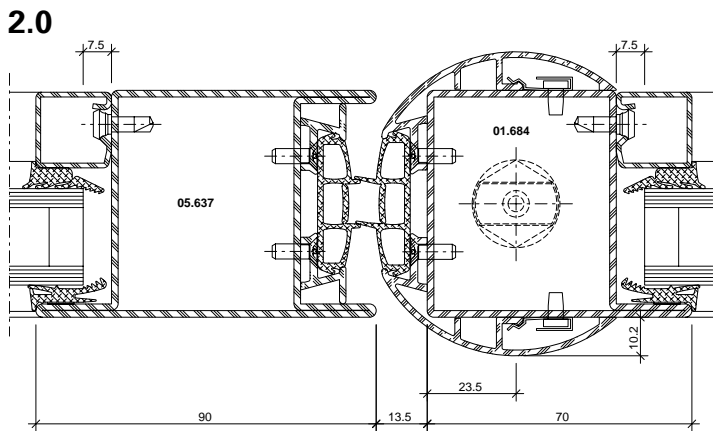

**DXF** **DWG** 22-0103-C-002

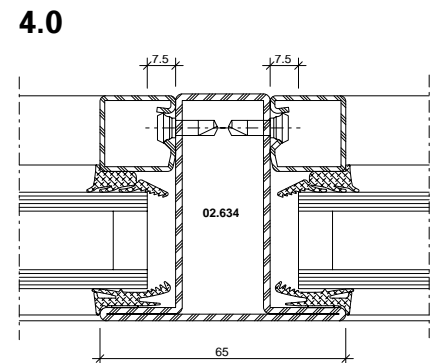

22-0101-C-002  
**DXF** **DWG**

5.0

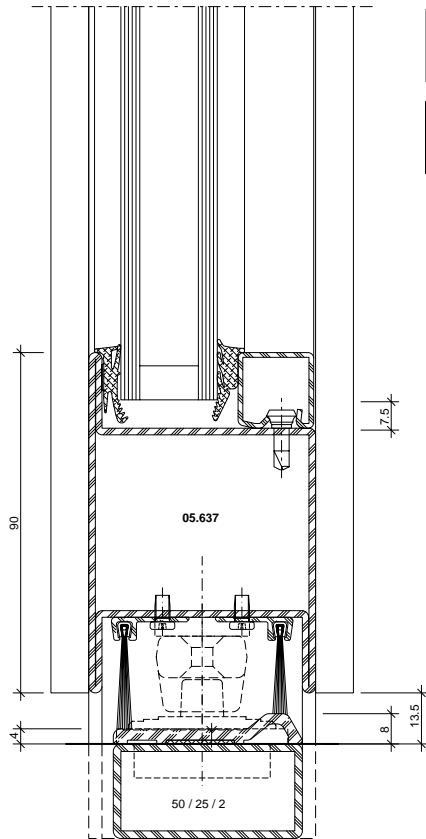

DWG

DXF

22-0103-C-003

5.1

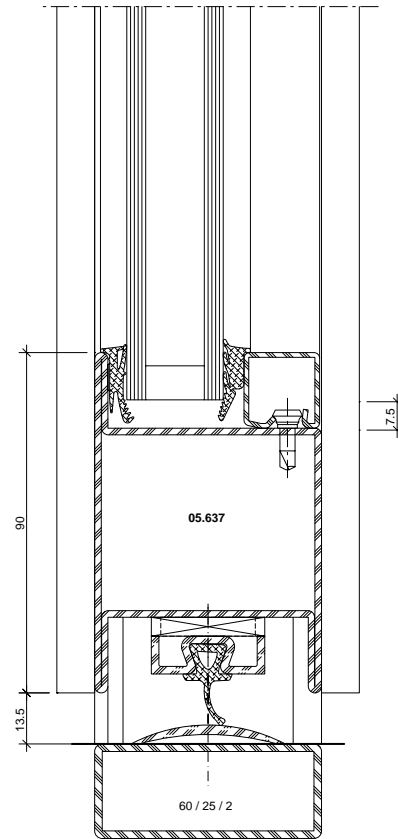

DWG

DXF

22-0103-C-009

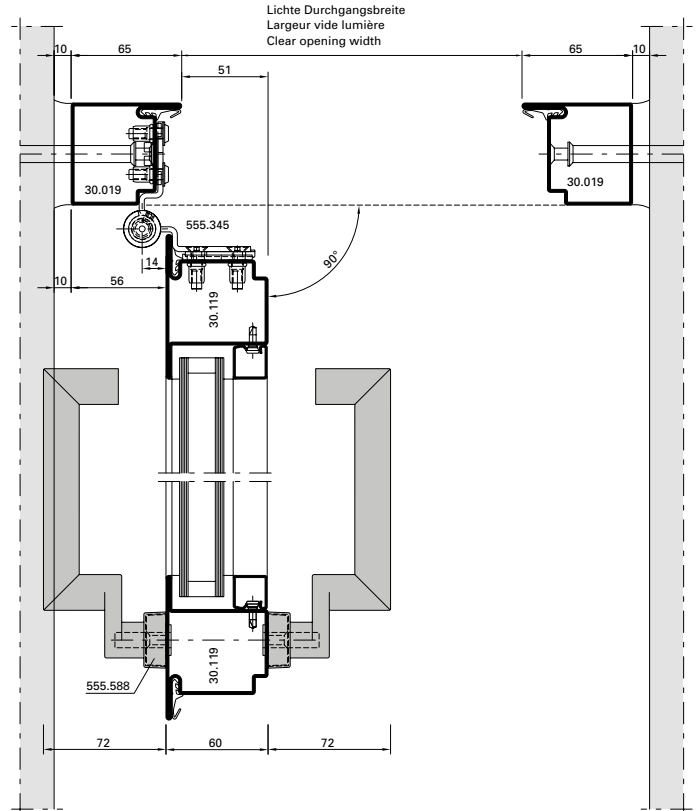
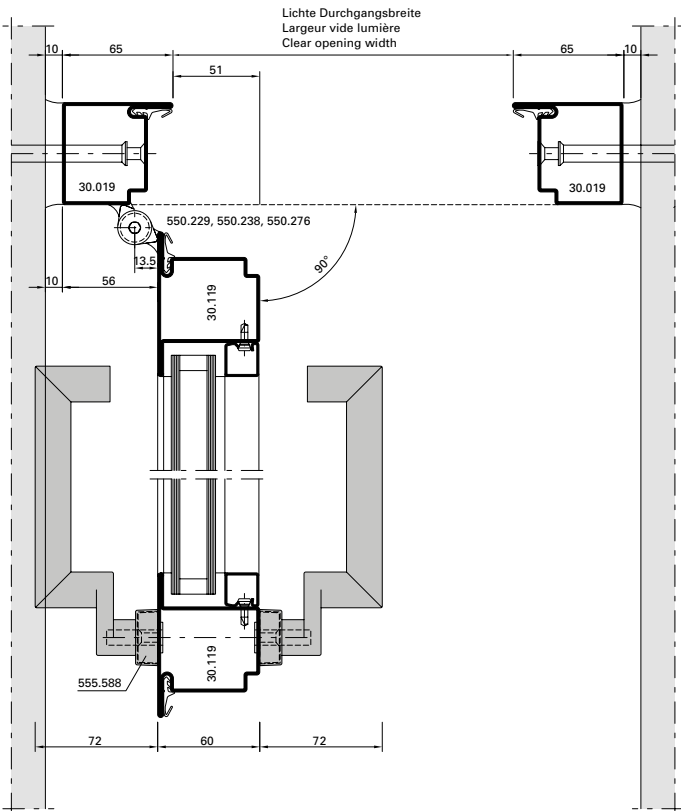

**DXF** **DWG** *D-250-E-016*

**DXF** **DWG** *D-250-E-018*

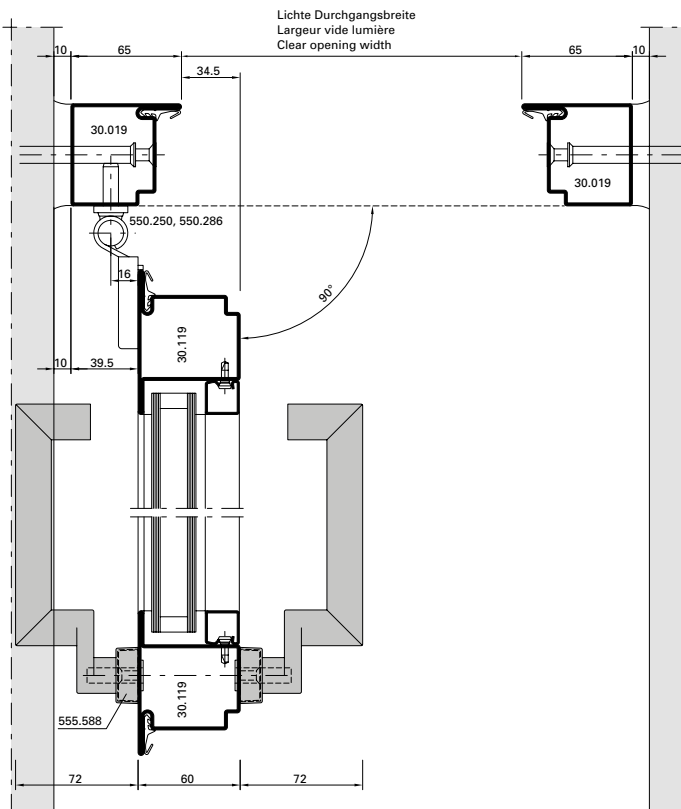

**DXF** **DWG** *D-250-E-020*

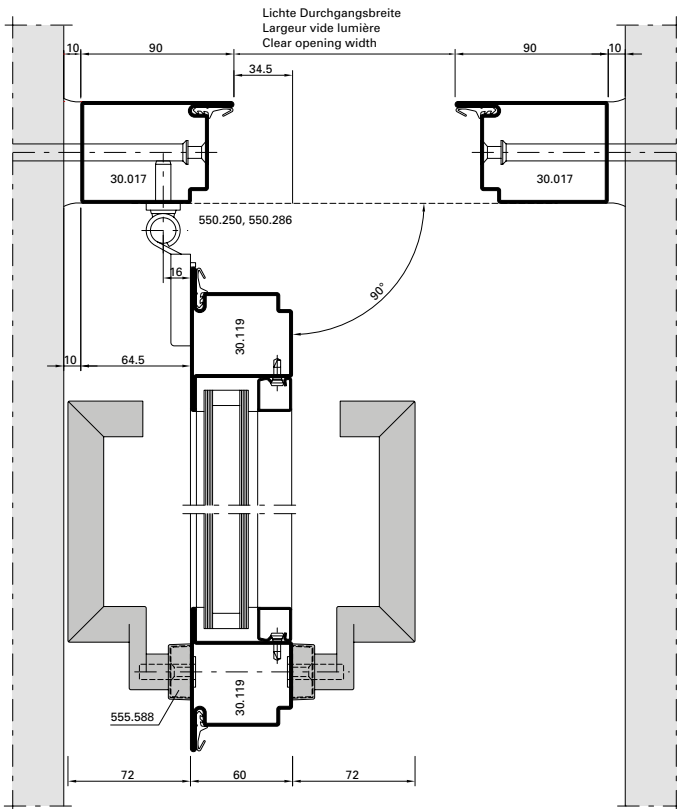

**DXF** **DWG** *D-250-E-021*

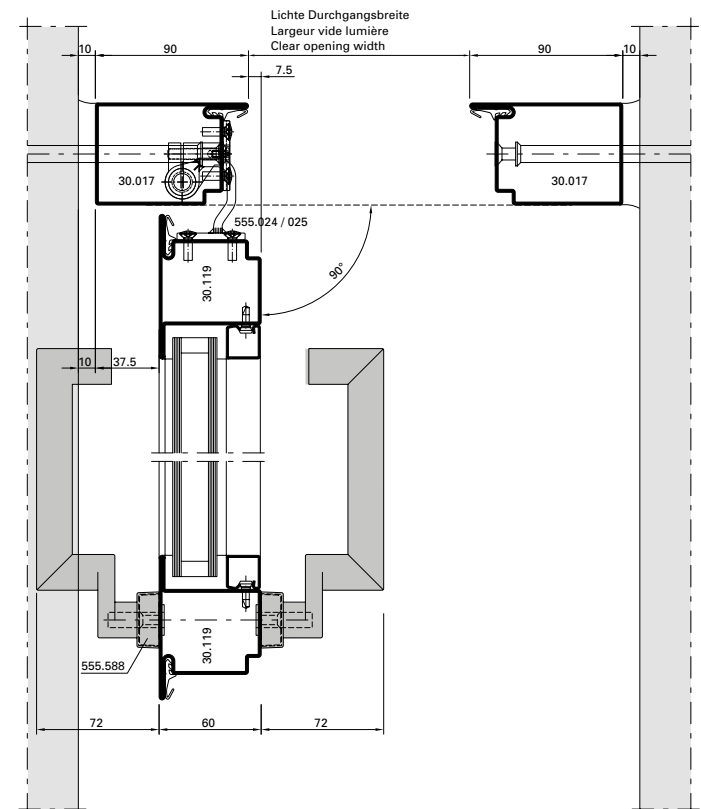

**DXF** **DWG** *D-250-E-025*



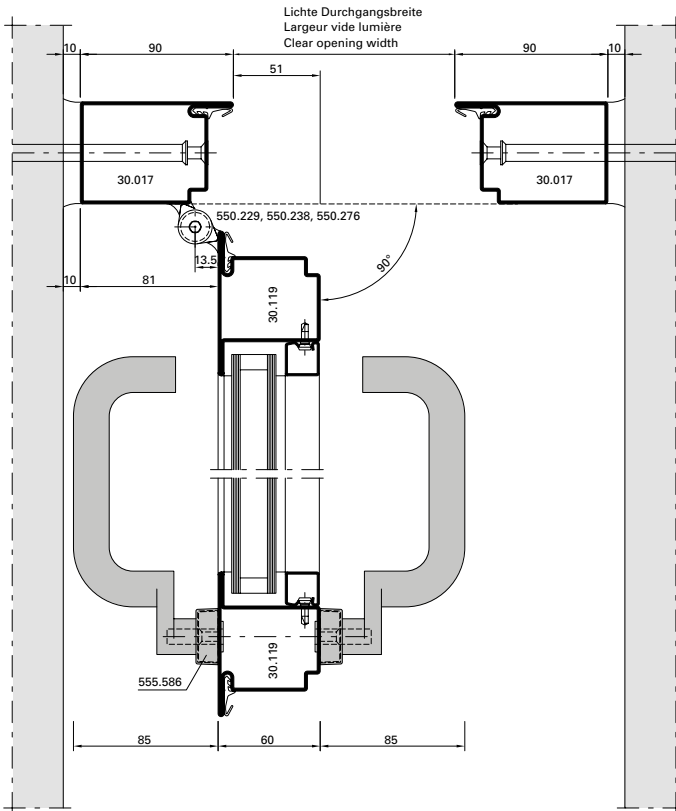

**DXF** **DWG** *D-250-E-017*

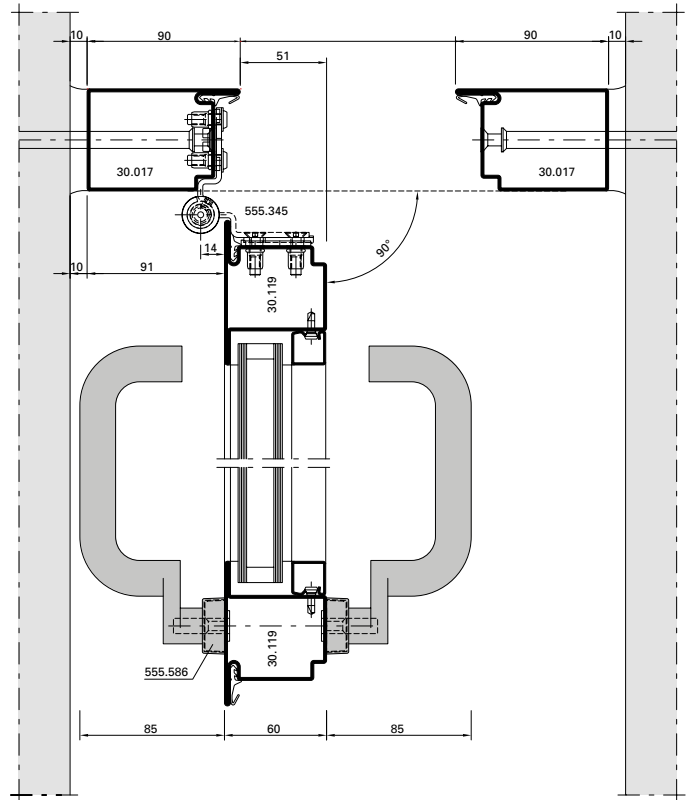

**DXF** **DWG** *D-250-E-019*

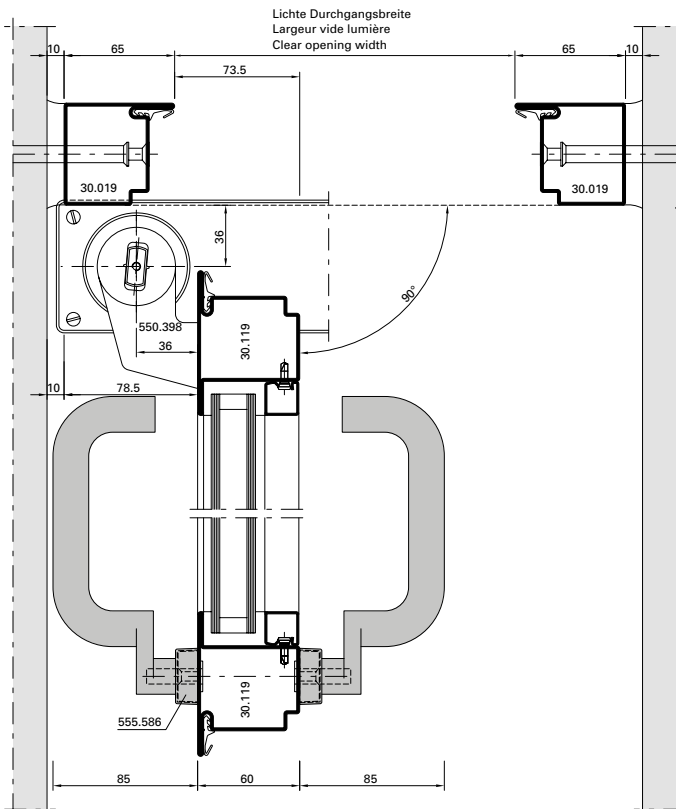

**DXF** **DWG** *D-250-E-022*

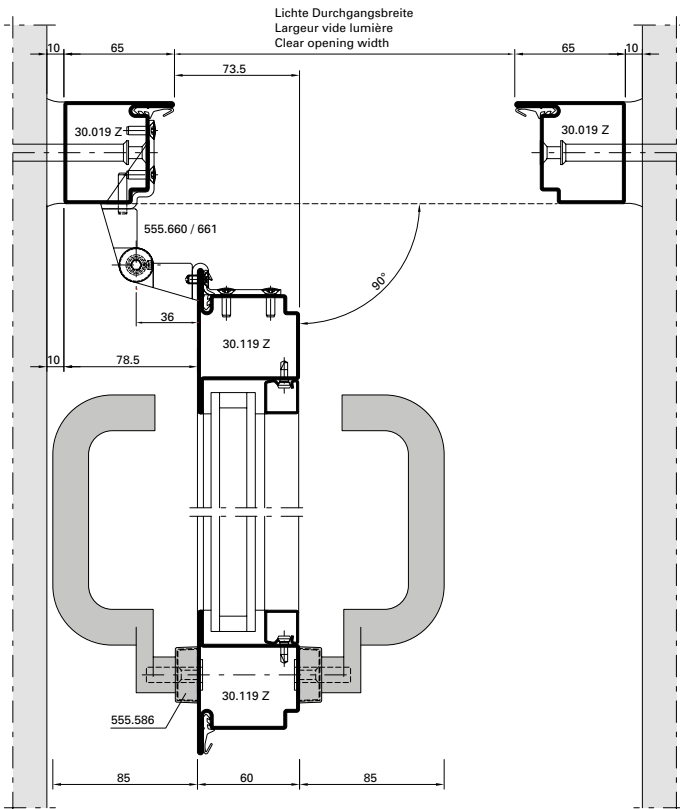

**DXF** **DWG** *D-250-E-023*

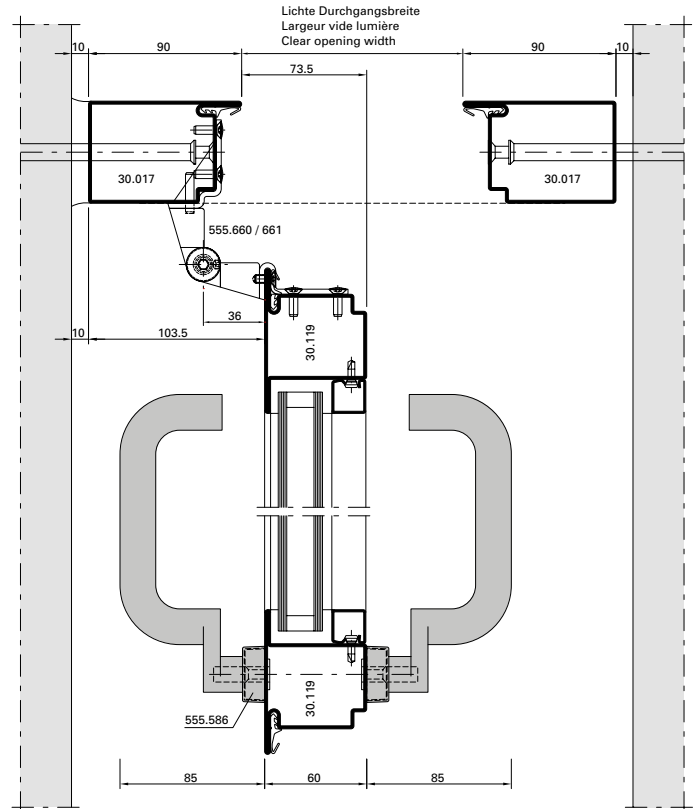

**DXF** **DWG** *D-250-E-024*

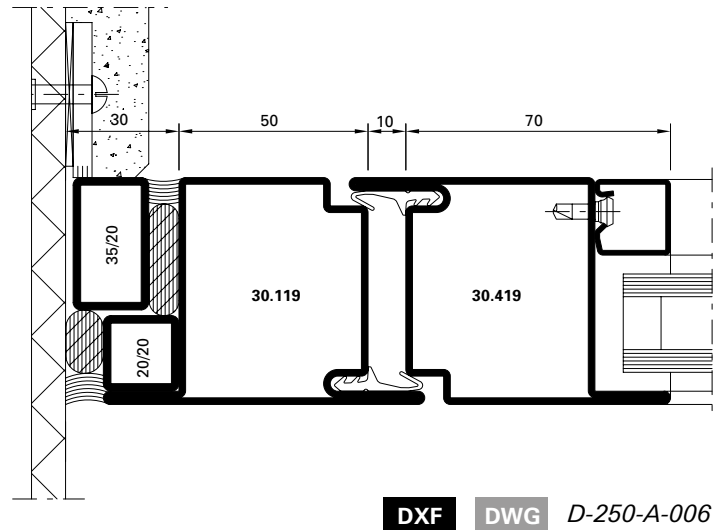
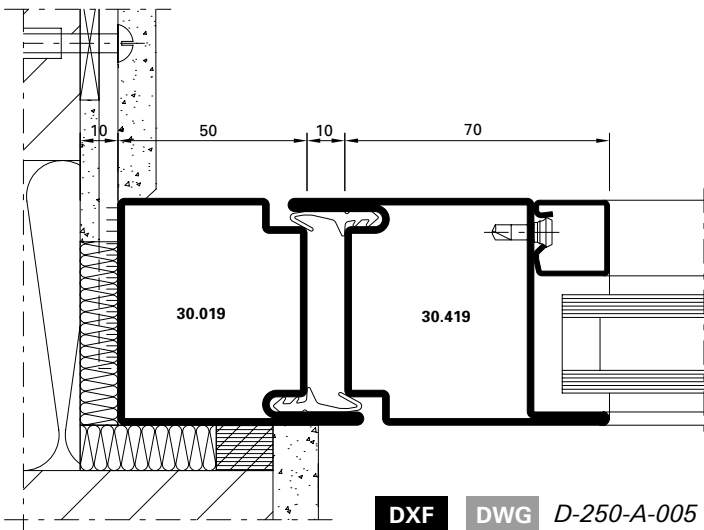
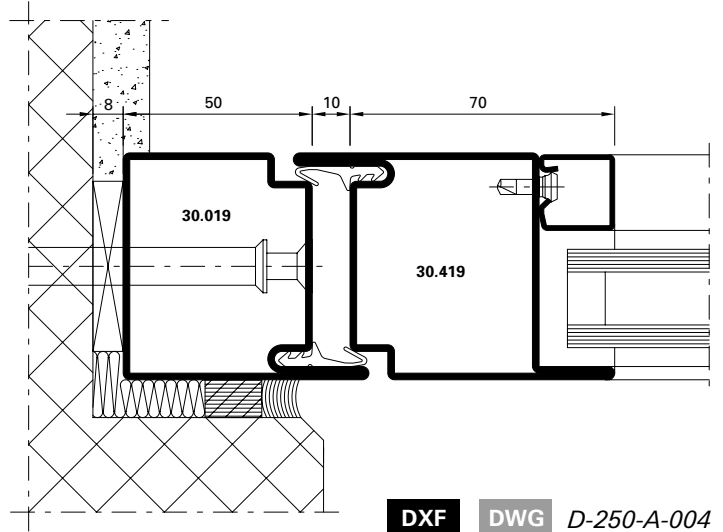
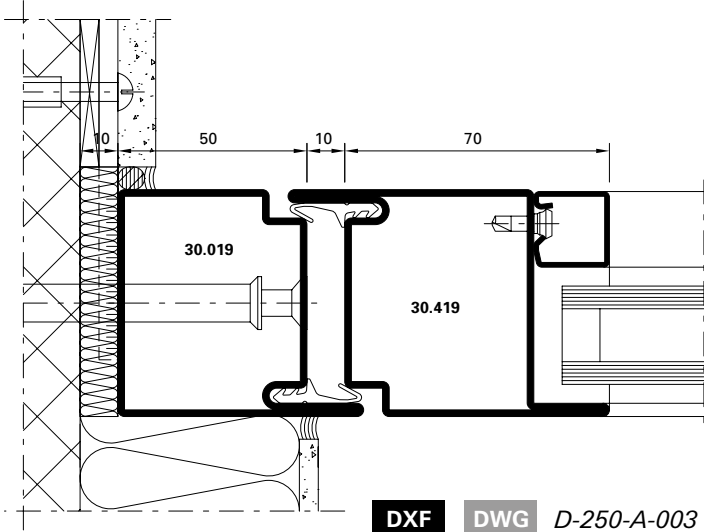
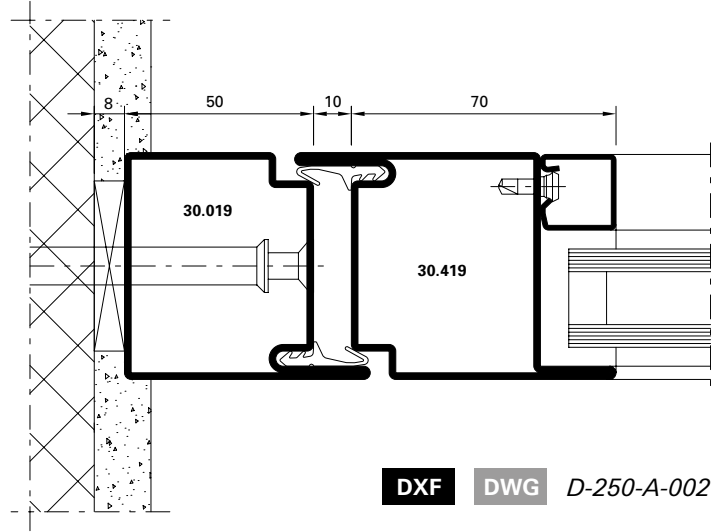
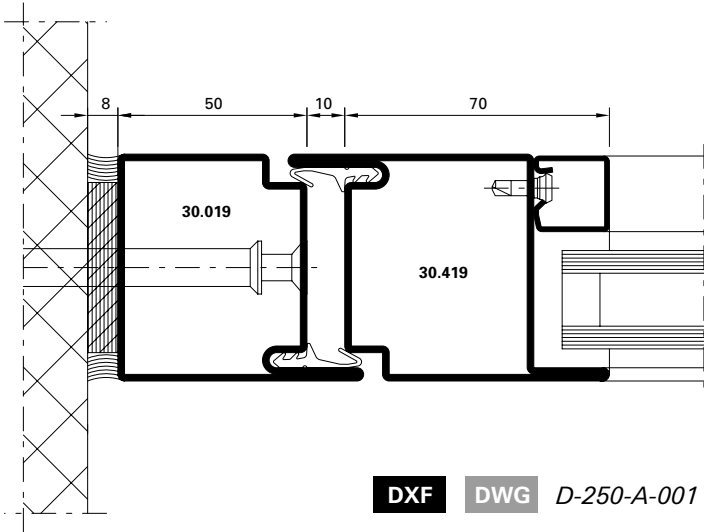

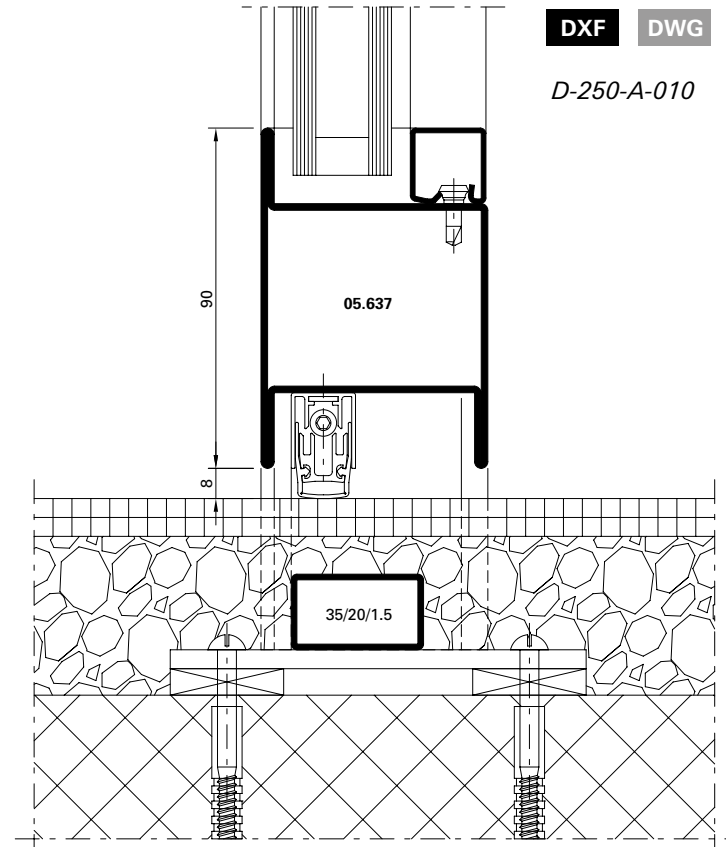
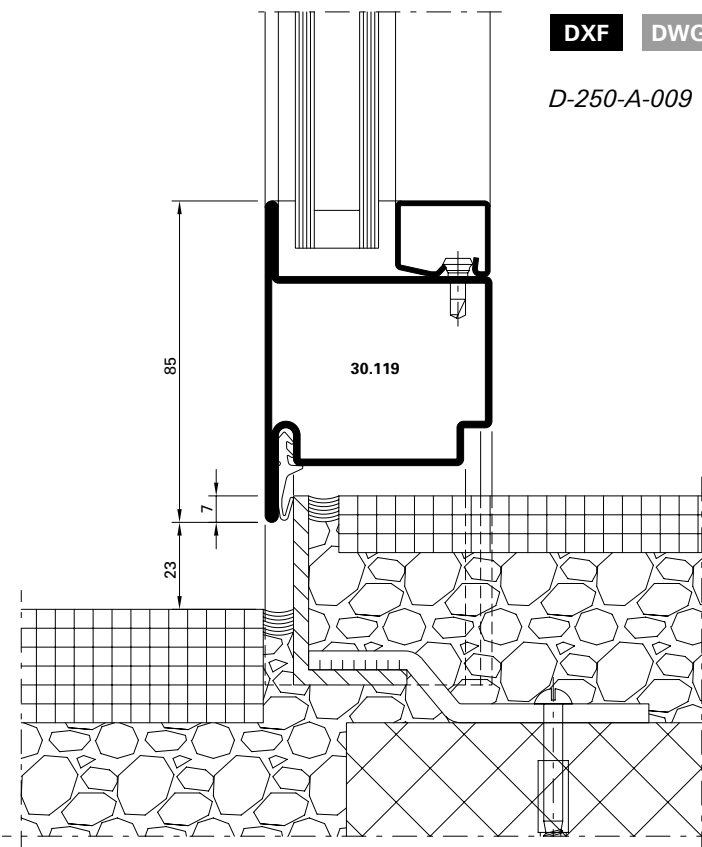
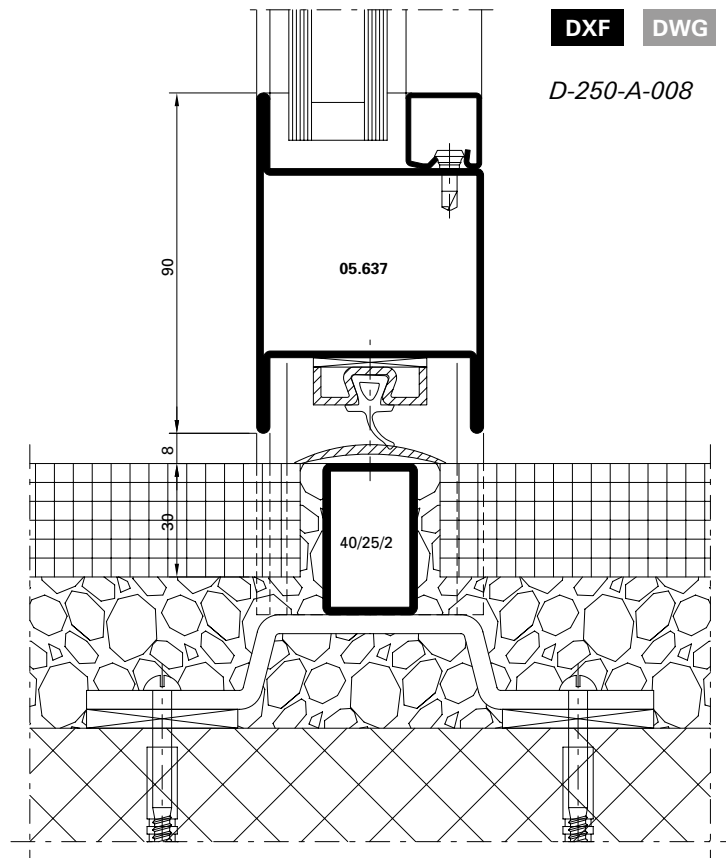
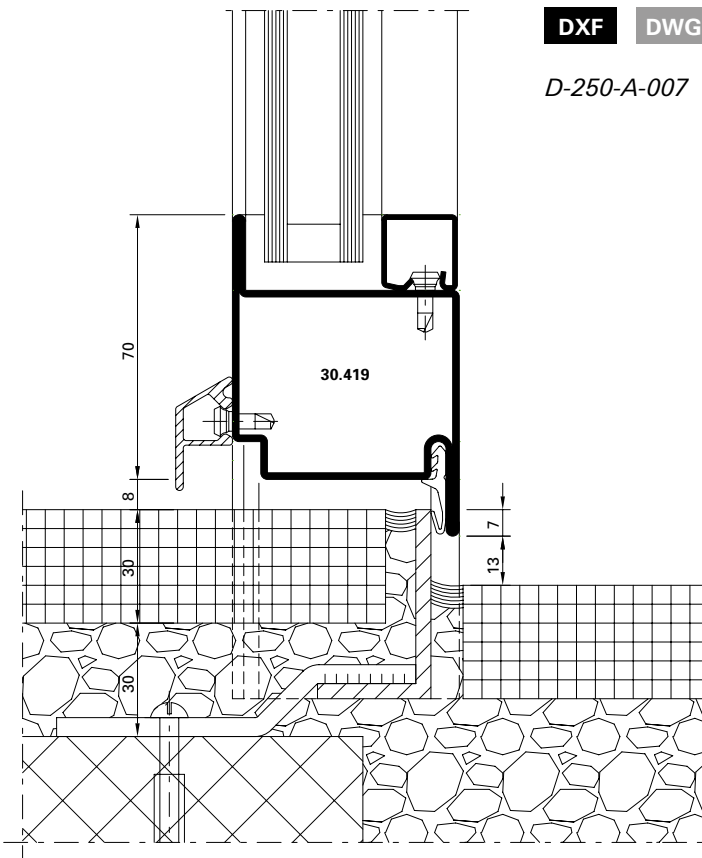



Einflügelige Türen,  
 auswärts öffnend,  
 Flügelhöhe ≤ 2200 mm

Porte à un vantail,  
 ouvrant vers l'extérieur,  
 hauteur du vantail ≤ 2200 mm

Single leaf door,  
 outward opening,  
 leaf height ≤ 2200 mm

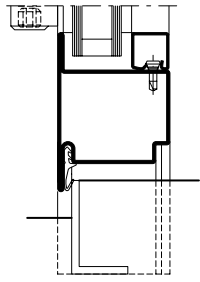
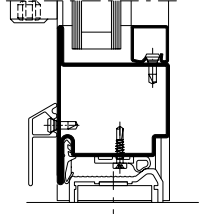
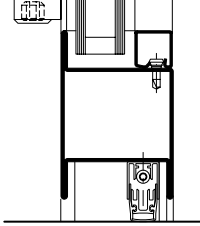
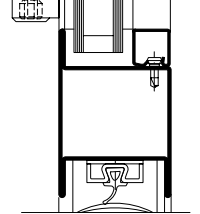
Variante	Beschlag Ferrure Fitting	 EN 12207	 EN 12208	 EN 12210
Anschlagdichtung Joint de butée Rebate gasket 	1	2	1A	C4
	2	2	2A	C4
	3	3	2A	C5
Doppel-Anschlagdichtung Joint de base double Double rebate gasket 	1	4	3A	C4
	2	4	3A	C4
	3	4	5A	C5
Senkdichtung Joint seuil Drop seal 	1	2	1A	C4
	2	2	2A	C4
	3	3	2A	C5
Auflaufdichtung Joint de contact Ramp seal 	1	2	0	C4
	2	2	0	C4
	3	2	0	C5

1 Fallenriegel-Schloss  
 Serrure à mortaiser  
 Latch and bolt lock





2 Schloss mit Obenverriegelung  
 Serrure avec verrouillage supérieur  
 Lock with top locking point

3 Mehrfachverriegelungs-Schloss  
 Serrure à verrouillage multiple  
 Multipoint lock

Einflügelige Türen,  
 einwärts öffnend,  
 Flügelhöhe ≤ 2200 mm

Porte à un vantail,  
 ouvrant vers l'intérieur,  
 hauteur du vantail ≤ 2200 mm

Single leaf door,  
 inward opening,  
 leaf height ≤ 2200 mm

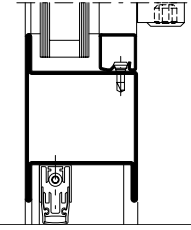
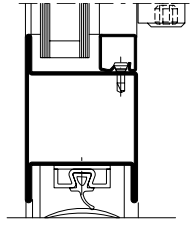
Variante		Beschlag Ferrure Fitting	 EN 12207	 EN 12208	 EN 12210
Senkdichtung Joint seuil Drop seal		❶	2	0	C4
		❷	2	0	C4
		❸	3	1A	C5
Auflaufdichtung Joint de contact Ramp seal		❶	2	0	C4
		❷	2	0	C4
		❸	2	0	C5

❶ Fallenriegel-Schloss  
 Serrure à mortaiser  
 Latch and bolt lock



❷ Schloss mit Obenverriegelung  
 Serrure avec verrouillage supérieur  
 Lock with top locking point

❸ Mehrfachverriegelungs-Schloss  
 Serrure à verrouillage multiple  
 Multipoint lock

Einflügelige Türen,  
 auswärts öffnend,  
 Flügelhöhe ≤ 3000 mm

Porte à un vantail,  
 ouvrant vers l'extérieur,  
 hauteur du vantail ≤ 3000 mm

Single leaf door,  
 outward opening,  
 leaf height ≤ 3000 mm

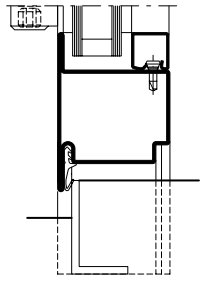
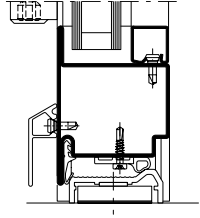
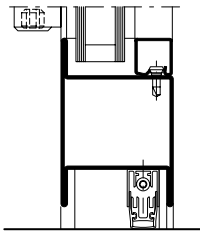
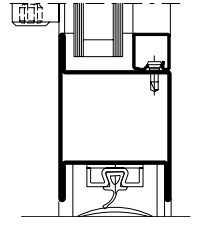
Variante	Beschlag Ferrure Fitting	 EN 12207	 EN 12208	 EN 12210
Anschlagdichtung Joint de butée Rebate gasket 	1	1	0	C1
	2	1	0	C1
	3	1	0	C2
Doppel-Anschlagdichtung Joint de base double Double rebate gasket 	1	1	1A	C1
	2	1	1A	C1
	3	2	2A	C2
Senkdichtung Joint seuil Drop seal 	1	1	0	C1
	2	1	0	C1
	3	1	0	C2
Aufbaudichtung Joint de contact Ramp seal 	1	0	0	C1
	2	0	0	C1
	3	1	0	C2

1 Fallenriegel-Schloss  
 Serrure à mortaiser  
 Latch and bolt lock





2 Schloss mit Obenverriegelung  
 Serrure avec verrouillage supérieur  
 Lock with top locking point

3 Mehrfachverriegelungs-Schloss  
 Serrure à verrouillage multiple  
 Multipoint lock

Einflügelige Türen,  
 einwärts öffnend,  
 Flügelhöhe ≤ 3000 mm

Porte à un vantail,  
 ouvrant vers l'intérieur,  
 hauteur du vantail ≤ 3000 mm

Single leaf door,  
 inward opening,  
 leaf height ≤ 3000 mm

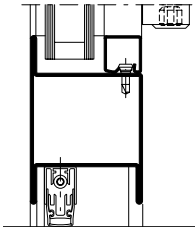
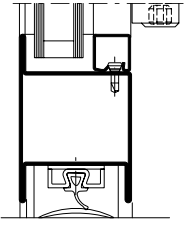
Variante		Beschlag Ferrure Fitting	 EN 12207	 EN 12208	 EN 12210
Senkdichtung Joint seuil Drop seal		❶	1	0	C1
		❷	1	0	C1
		❸	1	0	C2
Auflaufdichtung Joint de contact Ramp seal		❶	0	0	C1
		❷	0	0	C1
		❸	1	0	C2

❶ Fallenriegel-Schloss  
 Serrure à mortaiser  
 Latch and bolt lock

❷ Schloss mit Obenverriegelung  
 Serrure avec verrouillage supérieur  
 Lock with top locking point



❸ Mehrfachverriegelungs-Schloss  
 Serrure à verrouillage multiple  
 Multipoint lock



Zweiflügelige Türen,  
 auswärts öffnend,  
 Flügelhöhe ≤ 2200 mm

Porte à deux vantaux,  
 ouvrant vers l'extérieur,  
 hauteur du vantail ≤ 2200 mm

Double leaf door,  
 outward opening,  
 leaf height ≤ 2200 mm

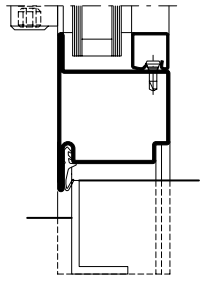
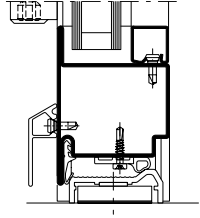
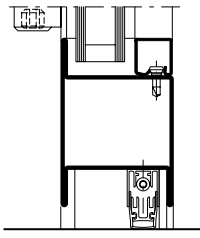
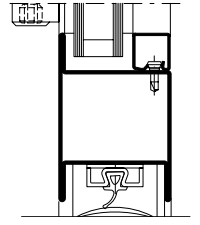
Variante	Beschlag Ferrure Fitting	 EN 12207	 EN 12208	 EN 12210
Anschlagdichtung Joint de butée Rebate gasket 	1	2	1A	C2
	2	2	2A	C2
	3	2	2A	C3
Doppel-Anschlagdichtung Joint de base double Double rebate gasket 	1	2	2A	C2
	2	2	2A	C2
	3	3	3A	C3
Senkdichtung Joint seuil Drop seal 	1	2	1A	C2
	2	2	2A	C2
	3	2	2A	C3
Auflaufdichtung Joint de contact Ramp seal 	1	2	0	C2
	2	2	0	C2
	3	2	0	C3

1 Fallenriegel-Schloss  
 Serrure à mortaiser  
 Latch and bolt lock





2 Schloss mit Obenverriegelung  
 Serrure avec verrouillage supérieur  
 Lock with top locking point

3 Mehrfachverriegelungs-Schloss  
 Serrure à verrouillage multiple  
 Multipoint lock

Zweiflügelige Türen,  
 einwärts öffnend,  
 Flügelhöhe ≤ 2200 mm

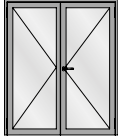
Porte à deux vantaux,  
 ouvrant vers l'intérieur,  
 hauteur du vantail ≤ 2200 mm

Double leaf door,  
 inward opening,  
 leaf height ≤ 2200 mm

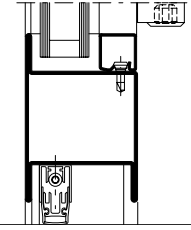
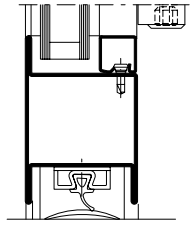
Variante		Beschlag Ferrure Fitting	 EN 12207	 EN 12208	 EN 12210
Senkdichtung Joint seuil Drop seal		❶	2	0	C2
		❷	2	0	C2
		❸	2	0	C3
Auflaufdichtung Joint de contact Ramp seal		❶	2	0	C2
		❷	2	0	C2
		❸	2	0	C3

❶ Fallenriegel-Schloss  
 Serrure à mortaiser  
 Latch and bolt lock



❷ Schloss mit Obenverriegelung  
 Serrure avec verrouillage supérieur  
 Lock with top locking point

❸ Mehrfachverriegelungs-Schloss  
 Serrure à verrouillage multiple  
 Multipoint lock

Zweiflügelige Türen,  
 auswärts öffnend,  
 Flügelhöhe ≤ 3000 mm

Porte à deux vantaux,  
 ouvrant vers l'extérieur,  
 hauteur du vantail ≤ 3000 mm

Double leaf door,  
 outward opening,  
 leaf height ≤ 3000 mm

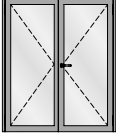
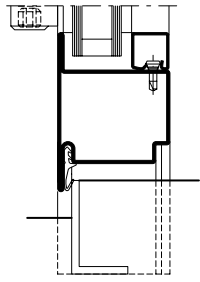
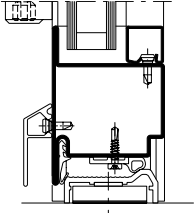
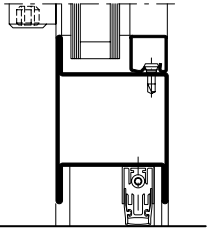
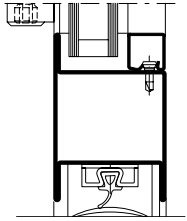
Variante	Beschlag Ferrure Fitting	 EN 12207	 EN 12208	 EN 12210	
					
Anschlagdichtung Joint de butée Rebate gasket		1	0	0	C1
		2	0	0	C1
		3	1	0	C2
Doppel-Anschlagdichtung Joint de base double Double rebate gasket		1	1	0	C1
		2	1	0	C1
		3	2	0	C2
Senkdichtung Joint seuil Drop seal		1	0	0	C1
		2	0	0	C1
		3	1	0	C2
Auflaufdichtung Joint de contact Ramp seal		1	0	0	C1
		2	0	0	C1
		3	1	0	C2

1 Fallenriegel-Schloss  
 Serrure à mortaiser  
 Latch and bolt lock





2 Schloss mit Obenverriegelung  
 Serrure avec verrouillage supérieur  
 Lock with top locking point

3 Mehrfachverriegelungs-Schloss  
 Serrure à verrouillage multiple  
 Multipoint lock

Zweiflügelige Türen,  
 einwärts öffnend,  
 Flügelhöhe ≤ 3000 mm

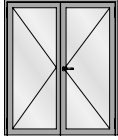
Porte à deux vantaux,  
 ouvrant vers l'intérieur,  
 hauteur du vantail ≤ 3000 mm

Double leaf door,  
 inward opening,  
 leaf height ≤ 3000 mm

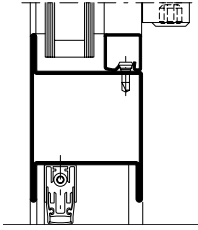
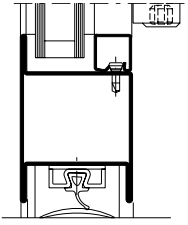
Variante		Beschlag Ferrure Fitting	 EN 12207	 EN 12208	 EN 12210
Senkdichtung Joint seuil Drop seal		1	0	0	C1
		2	0	0	C1
		3	1	0	C2
Auflaufdichtung Joint de contact Ramp seal		1	0	0	C1
		2	0	0	C1
		3	1	0	C2

**U<sub>f</sub>-Werte**  
(nach EN ISO 10077-2:2018-01)

**Valeurs U<sub>f</sub>**  
(selon EN ISO 10077-2:2018-01)

**U<sub>f</sub> values**  
(according to  
EN ISO 10077-2:2018-01)

Auf den folgenden Seiten  
finden Sie die U<sub>f</sub>-Werte für die  
verschiedenen Anwendungen von  
Jansen-Economy 60.

Vous trouverez les valeurs U<sub>f</sub>  
pour les différentes applications  
Jansen-Economy 60 dans les  
pages qui suivent.

On the following pages you  
will find the U<sub>f</sub> values for the  
various applications for  
Jansen-Economy 60.

Sie basieren auf folgenden  
Grundlagen:

Elles se basent sur les principes  
suivants:

They are based on the following:

**Stahl**

- Profile bandverzinkter Stahl,  
unbeschichtet
- Stahl-Glasleisten
- Trockenverglasung
- Nassverglasung

**Acier**

- Profilés en bande d'acier zingué,  
sans revêtement
- Parcloses en acier
- Vitrage à sec
- Vitrage à mastic



**Steel**

- Strip galvanised steel profiles,  
uncoated
- Steel glazing beads
- Glazing with dry glazing
- Glazing with sealing

**U<sub>f</sub>-Werte**  
 (nach EN ISO 10077-2:2018-01)

**Valeurs U<sub>f</sub>**  
 (selon EN ISO 10077-2:2018-01)

**U<sub>f</sub> values**  
 (according to EN ISO 10077-2:2018-01)

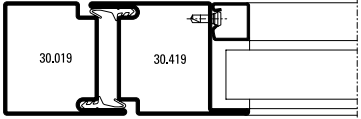
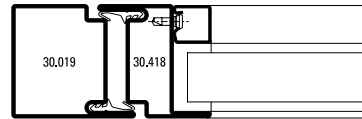
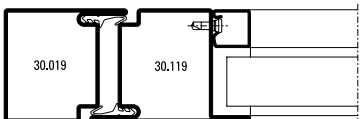
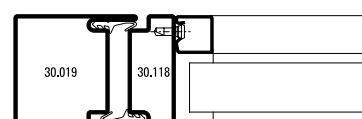
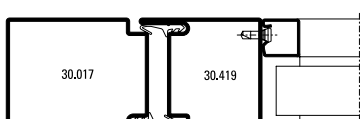
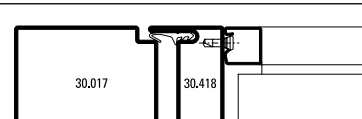
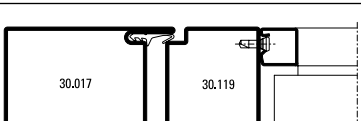
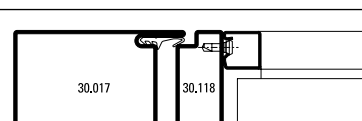
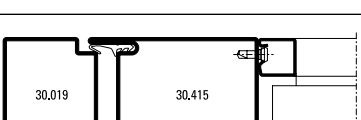
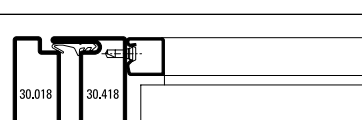
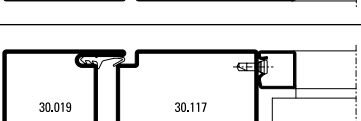
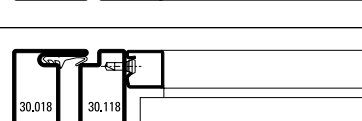
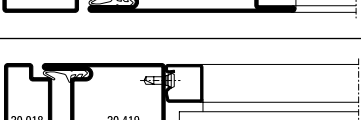
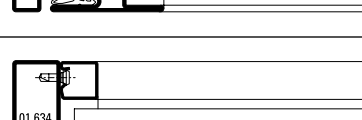
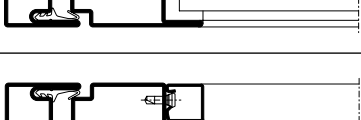
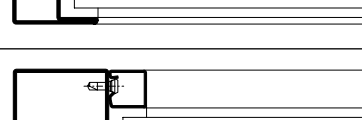
 Füllelementstärken Elements de remplissages Infill elements ≥ 24 mm		 Füllelementstärken Elements de remplissages Infill elements ≥ 24 mm	
	5,5 W/m <sup>2</sup> K		5,7 W/m <sup>2</sup> K
	5,6 W/m <sup>2</sup> K		5,8 W/m <sup>2</sup> K
	5,3 W/m <sup>2</sup> K		5,5 W/m <sup>2</sup> K
	5,3 W/m <sup>2</sup> K		5,5 W/m <sup>2</sup> K
	5,3 W/m <sup>2</sup> K		6,0 W/m <sup>2</sup> K
	5,3 W/m <sup>2</sup> K		6,1 W/m <sup>2</sup> K
	5,6 W/m <sup>2</sup> K		6,9 W/m <sup>2</sup> K
	5,7 W/m <sup>2</sup> K		6,1 W/m <sup>2</sup> K

**U<sub>f</sub>-Werte**  
 (nach EN ISO 10077-2:2018-01)

**Valeurs U<sub>f</sub>**  
 (selon EN ISO 10077-2:2018-01)

**U<sub>f</sub> values**  
 (according to EN ISO 10077-2:2018-01)

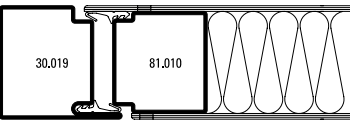
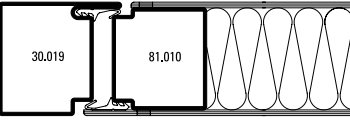
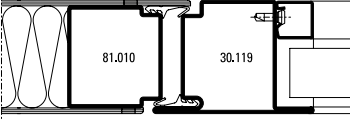
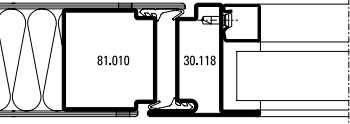
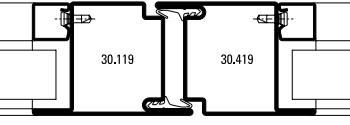
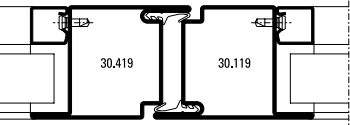
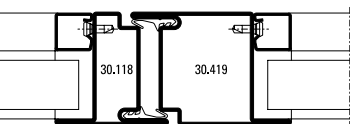
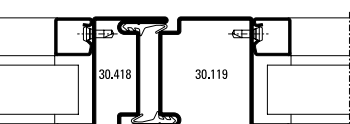
 Füllelementstärken Elements de remplissages Infill elements	≥ 24 mm
	5,3 W/m²K
	5,3 W/m²K
	5,7 W/m²K
	6,0 W/m²K
	5,8 W/m²K
	5,8 W/m²K
	6,1 W/m²K
	6,1 W/m²K

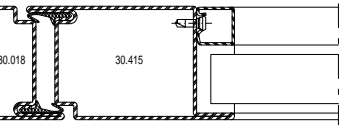
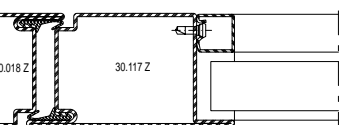
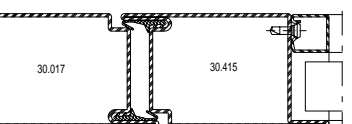
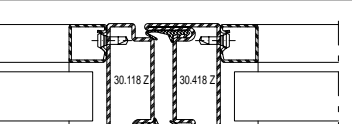
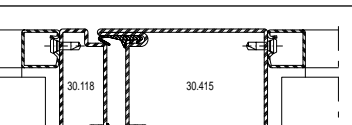
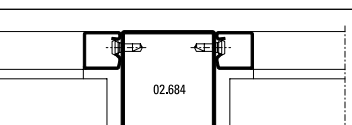
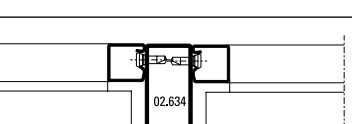
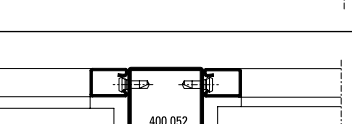
 Füllelementstärken Elements de remplissages Infill elements	≥ 24 mm
	5,3 W/m²K
	5,4 W/m²K
	5,1 W/m²K
	6,5 W/m²K
	5,7 W/m²K
	6,3 W/m²K
	7,2 W/m²K
	6,4 W/m²K

**U<sub>f</sub>-Werte**  
 (nach EN ISO 10077-2:2018-01)

**Valeurs U<sub>f</sub>**  
 (selon EN ISO 10077-2:2018-01)

**U<sub>f</sub> values**  
 (according to EN ISO 10077-2:2018-01)

	Füllelementstärken Elements de remplissages Infill elements  ≥ 24 mm
	<b>5,5 W/m²K</b>
	<b>5,7 W/m²K</b>
	<b>5,5 W/m²K</b>
	<b>5,3 W/m²K</b>
	<b>5,3 W/m²K</b>

	Füllelementstärken Elements de remplissages Infill elements  ≥ 24 mm
	<b>5,8 W/m²K</b>
	<b>6,0 W/m²K</b>
	<b>5,4 W/m²K</b>
	<b>5,1 W/m²K</b>

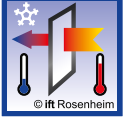
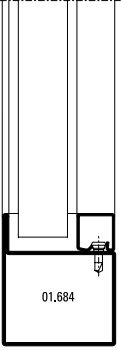
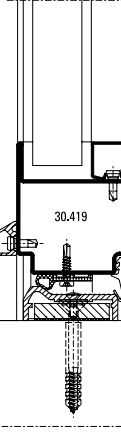
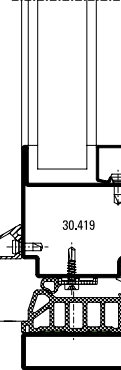

**U<sub>f</sub>-Werte**  
 (nach EN ISO 10077-2:2018-01)

 Füllelementstärken Elements de remplissages Infill elements ≥ 24 mm	
 01.684	6,1 W/m <sup>2</sup> K
 30.419	6,3 W/m <sup>2</sup> K
 30.419	5,6 W/m <sup>2</sup> K

**Valeurs U<sub>f</sub>**  
 (selon EN ISO 10077-2:2018-01)

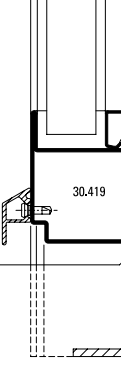
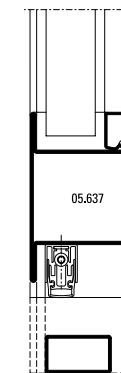
 Füllelementstärken Elements de remplissages Infill elements ≥ 24 mm	
 30.419	6,3 W/m <sup>2</sup> K
 05.637	5,6 W/m <sup>2</sup> K

**U<sub>f</sub> values**  
 (according to EN ISO 10077-2:2018-01)

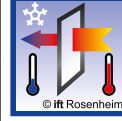
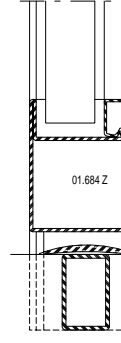
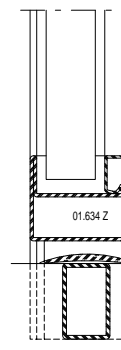
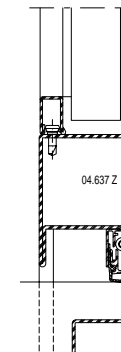
 Füllelementstärken Elements de remplissages Infill elements ≥ 24 mm	
 01.684 Z	6,1 W/m <sup>2</sup> K
 01.634 Z	6,8 W/m <sup>2</sup> K
 04.637 Z	5,5 W/m <sup>2</sup> K

**U<sub>f</sub>-Werte**  
 (nach EN ISO 10077-2:2018-01)

**Valeurs U<sub>f</sub>**  
 (selon EN ISO 10077-2:2018-01)

**U<sub>f</sub> values**  
 (according to EN ISO 10077-2:2018-01)

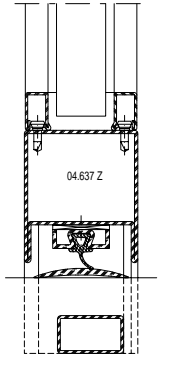
 Füllelementstärken Elements de remplissages Infill elements ≥ 24 mm	
	5,6 W/m <sup>2</sup> K

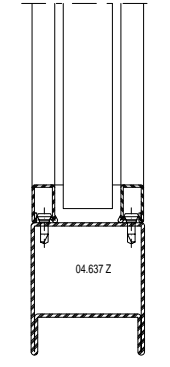
 Füllelementstärken Elements de remplissages Infill elements ≥ 24 mm	
	5,6 W/m <sup>2</sup> K

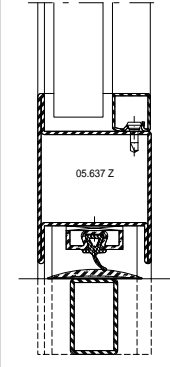
 Füllelementstärken Elements de remplissages Infill elements ≥ 24 mm	
	5,7 W/m <sup>2</sup> K

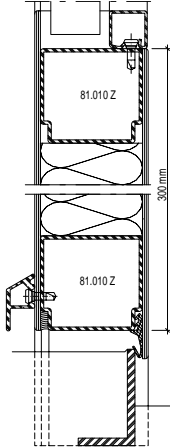
	4,4 W/m <sup>2</sup> K
--	------------------------

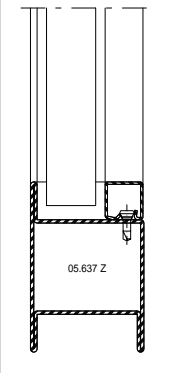
	5,7 W/m <sup>2</sup> K
--	------------------------

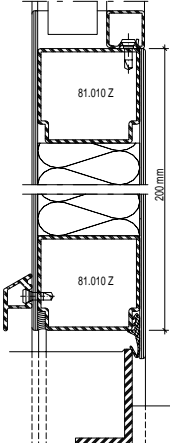
	5,2 W/m <sup>2</sup> K
---	------------------------



## Schallschutz

### Ausführungsvarianten

Die nachfolgende Typenübersicht ergibt einen Überblick über die beurteilten Varianten.

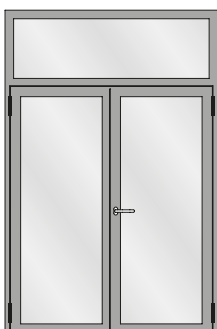
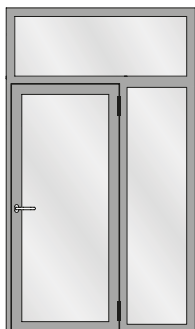
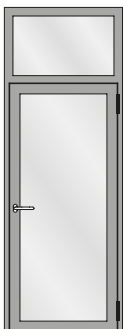
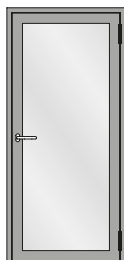

## Isolation phonique

### Modèles

L'aperçu des types suivant fournit une vue d'ensemble des variantes examinées.

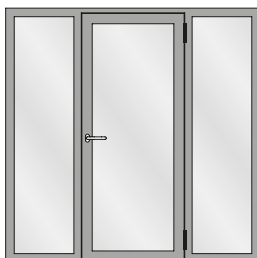
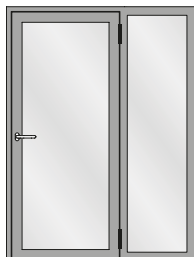
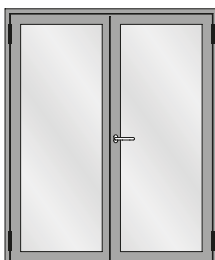

## Sound insulation

### Design range

The following overview of types provides an overview of the evaluated designs.

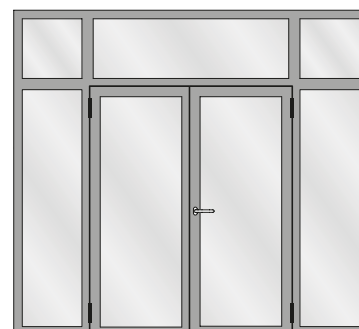
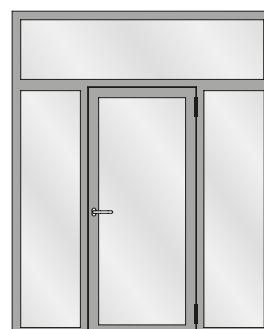

Schallschutz

Isolation phonique

Sound insulation

Tabelle A1

Korrekturtabelle für Jansen-Economy-Türen mit Glasfüllungen

Tableau A1

Tableau de correction pour les portes Jansen-Economy avec vitrage

Table A1

Correction table for Jansen-Economy doors with glass

	1	2	3	4	5	6	7	8	9	10	11
	<b>Türe</b> mit zwei absenkba- ren Bodendichtungen <b>Porte</b> avec deux joint seuil automatique <b>Door</b> with two threshold gaskets that can be lowered	<b>Glas</b>  <b>Verre</b>  <b>Glass</b>	<b>Korrekturen</b>  <b>Corrections</b>  <b>Corrections</b>								
	$R_{w(C, Ctr)}$ dB	$R_{w, P, Glas}$ dB	$K_S$ dB	$K_{FV}$ dB	$K_{Nass}$ dB	$K_{1aB}$ dB	$K_{W/S}$ dB	$K_{G 0,4}$ dB	$K_{G 1,8}$ dB	$K_{G 2,6}$ dB	$K_{G 3,2}$ dB
1	32 (-1; -5)	31	0	-1	0	0	0	0	-1	-2	-3
2	33 (-1; -5)	32	0	-1	0	0	0	0	-1	-2	-3
3	35 (-1; -5)	34	0	-1	0	0	0	0	-1	-2	-3
4	36 (-2; -5)	35	0	-1	-1	0	0	0	-1	-2	-3
5	37 (-2; -5)	37	0	0	-1	0	-1	0	-1	-2	-3
6	38 (-2; -5)	39	0	0	-1	-1	-1	0	-1	-2	-3
7	39 (-2; -5)	40	0	0	-1	-1	-1	0	-1	-2	-3
8	40 (-2; -5)	41	0	0	-1	-1	-2	-1	-1	-2	-3
9	41 (-2; -5)	42	0	0	-1	-1	-2	-2	-1	-2	-3
10	42 (-2; -5)	43	-1	0	-1	-1	-2	-2	-1	-2	-3
11	42 (-2; -5)	44	-1	0	-1	-1	-2	-2	-1	-2	-3
12	43 (-2; -5)	45	-1	+1	-1	-1	-3	-3	-1	-2	-3
13	44 (-2; -5)	49	-1	+1	-1	-2	-3	-3	-1	-2	-3

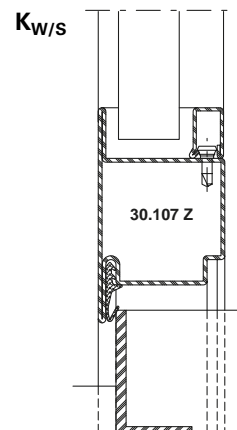
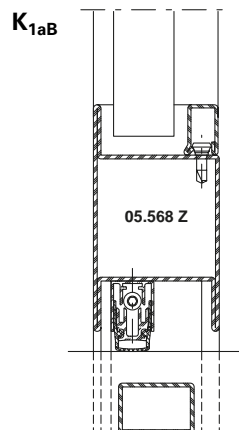
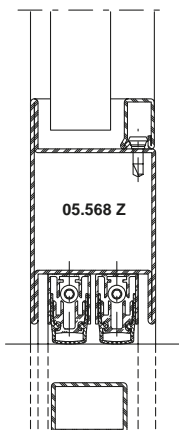

**Schallschutz**

*Der aus der Tabelle A1 abzulesende Wert für die Schalldämmung  $R_{w, Tür}$  beträgt:*

**Isolation phonique**

*La valeur à relever sur le tableau A1 concernant l'isolement contre les sons aériens  $R_{w, Porte}$  est la suivante:*

**Sound insulation**

*The value taken from table A1 for the sound insulation  $R_{w, Door}$  is:*

$$R_{w, Tür} = R_w + K_S + K_{FV} + K_{Nass} + K_{1aB} + K_{W/S} + K_{Band} + K_{G 0,4} + K_{G 1,8} + K_{G 2,6} + K_{G 3,2} \text{ dB}$$

- $R_w$**  bewertetes Schalldämm-Mass der Türe in Abhängigkeit von der Schalldämmung  $R_{w,P, Glas}$
- $R_{w,P, Glas}$**  bewertetes Schalldämm-Mass der Verglasung (Prüfwert nach ISO 140-3, mit Prüfnachweis einer PÜZ-Stelle). Alternativ können Tabellenwerte nach DIN EN 12758, Abschnitt 6 verwendet werden
- $K_S$**  Korrekturwert für zweiflügelige Türen
- $K_{FV}$**  Korrekturwert für Festverglasungen mit erhöhtem Scheibenanteil
- $K_{Nass}$**  Korrekturwert für Nassverglasung
- $K_{1aB}$**  Korrekturwert für Türen mit einer absenkbaren Bodendichtung
- $K_{Band}$**  Korrekturwert bei Verwendung von Anschlagbändern, die eine Dichtungsebene unterbrechen ( $K_{Band} = - 0,5 \text{ dB pro Band}$ )
- $K_{W/S}$**  Korrekturwert für Türen mit einer Anschlagsschwelle
- $K_{G 0,4}$**  Korrekturwert für Einzelscheiben mit einer Glasfläche  $\leq 0,4 \text{ m}^2$ . Die Korrektur gilt auch für Konstruktionen mit glasteilenden Sprossen.
- $K_{G 1,8}$**  Korrekturwert für Einzelscheiben mit einer Glasfläche  $\geq 1,8 \text{ m}^2$
- $K_{G 2,6}$**  Korrekturwert für Einzelscheiben mit einer Glasfläche  $\geq 2,6 \text{ m}^2$
- $K_{G 3,2}$**  Korrekturwert für Einzelscheiben mit einer Glasfläche  $\geq 3,2 \text{ m}^2$

- $R_w$**  Mesure d'isolement contre les sons aériens des portes évaluée suivant l'isolement phonique  $R_{w,P, Glas}$
- $R_{w,P, Glas}$**  Cote d'isolement acoustique du vitrage évalué (valeur contrôlée selon ISO 140-3 avec certificat d'un bureau de contrôle, de surveillance ou de certification). Il est également possible d'utiliser les valeurs selon le tableau DIN EN 12758, section 6
- $K_S$**  Valeur de correction pour portes à deux vantaux
- $K_{FV}$**  Valeur de correction pour vitrages fixes à fort pourcentage de vitre
- $K_{Nass}$**  Valeur de correction pour vitrage avec mastic
- $K_{1aB}$**  Valeur de correction pour portes avec un joint seuil automatique
- $K_{Band}$**  Valeur corrective en cas d'utilisation de paumelles qui interrompent un plan d'étanchéité ( $K_{Band} = - 0,5 \text{ dB par paumelle}$ )
- $K_{W/S}$**  Valeur de correction pour portes avec un seuil de butée
- $K_{G 0,4}$**  Valeur de correction pour vitres individuelles avec une surface vitrée  $\leq 0,4 \text{ m}^2$ . La correction s'applique aussi aux constructions à meneaux séparant les vitres.
- $K_{G 1,8}$**  Valeur de correction pour vitres individuelles avec surface vitrée  $\geq 1,8 \text{ m}^2$
- $K_{G 2,6}$**  Valeur de correction pour vitres individuelles avec surface vitrée  $\geq 2,6 \text{ m}^2$
- $K_{G 3,2}$**  Valeur de correction pour vitres individuelles avec surface vitrée  $\geq 3,2 \text{ m}^2$

- $R_w$**  Airborne sound reduction index of doors depending on the sound insulation  $R_{w,P, Glas}$
- $R_{w,P, Glas}$**  Airborne sound reduction index (test value in accordance with ISO 140-3, with a test certificate from a recognised testing, inspection or certification body). Alternatively, the tabulated values in DIN EN 12758, Section 6 may be used
- $K_S$**  Correction value for double-leaf doors
- $K_{FV}$**  Correction value for fixed glazing with increased proportion of pane
- $K_{Nass}$**  Correction value for glazing with sealing
- $K_{1aB}$**  Correction value for doors with a threshold gasket that can be lowered
- $K_{Band}$**  Correction value when using hinges that interrupt a sealing plane ( $K_{Band} = - 0.5 \text{ dB per hinge}$ )
- $K_{W/S}$**  Correction value for doors with a rebate threshold
- $K_{G 0,4}$**  Correction value for single panes with a glass area  $\leq 0,4 \text{ m}^2$ . The correction also applies to buildings with glazing bars
- $K_{G 1,8}$**  Correction value for single panes with a glass area  $\geq 1,8 \text{ m}^2$
- $K_{G 2,6}$**  Correction value for single panes with a glass area  $\geq 2,6 \text{ m}^2$
- $K_{G 3,2}$**  Correction value for single panes with a glass area  $\geq 3,2 \text{ m}^2$



# Jansen-Economy 60 Türen

Türen aus Stahl

# Portes Jansen-Economy 60

Portes en acier

# Jansen-Economy 60 doors

Doors in steel

Grafische Planungsdaten wie z.B. Anwendungsbeispiele, Konstruktionsdetails, Anschlüsse am Bau, die in unseren physischen oder elektronischen Dokumentationsunterlagen enthalten sind, sind schematische Darstellungen. Gleiches gilt für digitale Medien wie CAD Dateien oder BIM Modelle.

Sie sollen den ausführenden Metallbauer und/oder Fachplaner bei der Planung und Ausführung eines Projektes unterstützen. Sie sind im konkreten Anwendungsfall durch den ausführenden Metallbauer und/oder Fachplaner auf die Verwendbarkeit im konkreten betroffenen Projekt hinsichtlich rechtlichen/regulatorischen aber auch technischen objektspezifischen Anforderungen zu überprüfen und ggfs. eigenverantwortlich anzupassen.

Bei der Überprüfung, der spezifischen Planung und der Umsetzung sind die objektspezifischen Rahmenbedingungen (Material der Bausubstanz, Dimension des Einbauelements, Farbe, Exposition, Lasteinwirkung, etc.) sowie der geltende Stand der Technik einschliesslich aller anwendbaren Normen und technischen Richtlinien eigenverantwortlich zu beachten.

Falls das vorliegende Dokument Differenzen zur aktuellen deutschen Version (Artikel Nr. K1214237) aufweist, gilt in jedem Fall der deutsche Originaltext in der jeweils geltenden Fassung im Jansen Docu Center.

Alle Ausführungen dieser Dokumentation haben wir sorgfältig und nach bestem Wissen zusammengestellt. Wir können aber keine Verantwortung für die Benutzung der vermittelten Vorschläge und Daten übernehmen. Wir behalten uns technische Änderungen ohne Vorankündigung vor.

Les données de planification graphiques, comme les exemples d'application, détails de construction et raccordements au bâtiment, fournies dans notre documentation physique et numérique sont des représentations schématiques. Il en va de même pour les médias numériques comme les fichiers CAD ou modèles BIM.

Leur but est de faciliter la planification et réalisation d'un projet par les constructeurs métalliques et/ou concepteurs. Concrètement, elles doivent être vérifiées par le constructeur métallique et/ou le concepteur et, le cas échéant, modifiées de son propre chef pour s'assurer qu'elles concordent avec le projet concerné et qu'elles répondent aux exigences techniques spécifiques ainsi qu'aux dispositions légales et réglementaires.

Lors de la vérification, de la planification spécifique et de la mise en œuvre, il y a lieu de tenir compte des conditions spécifiques à l'objet (matériaux du bâtiment, dimension de l'élément d'insert, couleur, exposition, effet de charge, etc.) ainsi que de l'état actuel de la technique, y compris toutes les normes et directives techniques applicables.

En cas de divergence entre le présent document et la version allemande (no d'article K1214237), c'est dans tous les cas le texte original allemand qui prévaut dans sa version actuelle disponible dans le Jansen Docu Center.

Nous avons apporté le plus grand soin à l'élaboration de cette documentation. Cependant, nous déclinons toute responsabilité pour l'utilisation faite de nos propositions et de nos données.

Nous nous réservons le droit de procéder à des modifications techniques sans préavis.

Graphical planning data such as application examples, construction details, connections on site that are contained in our physical or electronic documentation components are schematic representations. The same applies to digital media such as CAD files or BIM models.

They are intended to support the metal worker and/or design engineer in planning and executing projects. In the specific case of application they are to be checked by the metal worker and/or design engineer in terms of their usability in the specific project concerned with regard to legal/regulatory and technical property-specific requirements and adjusted if necessary at the latter's own responsibility.

The property-specific underlying conditions (construction material, dimensions of installation element, colour, exposure, load effect etc.) and current state of the art including all applicable norms and technical guidelines are to be taken into consideration at the metal worker and/or design engineer's own responsibility during the review, specific planning and implementation.

If there are any differences between this document and the current German version (item number K1214237), the latest version of the original German text in the Jansen Docu Center shall prevail.

All the information contained in this documentation is given to the best of our knowledge and ability. However, we decline all responsibility for the use made of these suggestions and data.

We reserve the right to effect technical modifications without prior warning.



<p><b>Inhaltsverzeichnis</b>  <b>Sommaire</b>  <b>Content</b></p>		<p>Jansen-Economy 60 Türen  Jansen-Economy 60 portes  Jansen-Economy 60 doors</p>
<p><b>Systemübersicht</b>  Merkmale  Leistungseigenschaften  Systemausführungen  Typenübersicht</p>	<p><b>Sommaire du système</b>  Caractéristiques  Caractéristiques de performance  Exécutions de système  Sommaire des types</p>	<p><b>Summary of system</b>  Characteristics  Performance characteristics  System versions  Summary of types</p> <p><b>2</b></p>
<p><b>Profilsortiment</b></p>	<p><b>Assortiment de profilé</b></p>	<p><b>Range of profiles</b></p> <p><b>14</b></p>
<p><b>Beispiele</b>  Schnittpunkte  Konstruktionsdetails  Anschlüsse am Bau</p>	<p><b>Exemples</b>  Coupes de détails  Détails de construction  Raccords au mur</p>	<p><b>Examples</b>  Section details  Construction details  Attachment to structure</p> <p><b>18</b></p>
<p><b>Leistungseigenschaften</b></p>	<p><b>Caractéristiques de performance</b></p>	<p><b>Performance characteristics</b></p> <p><b>36</b></p>

**Merkmale**  
**Caractéristiques**  
**Characteristics**

Jansen-Economy 60 Türen  
Jansen-Economy 60 portes  
Jansen-Economy 60 doors







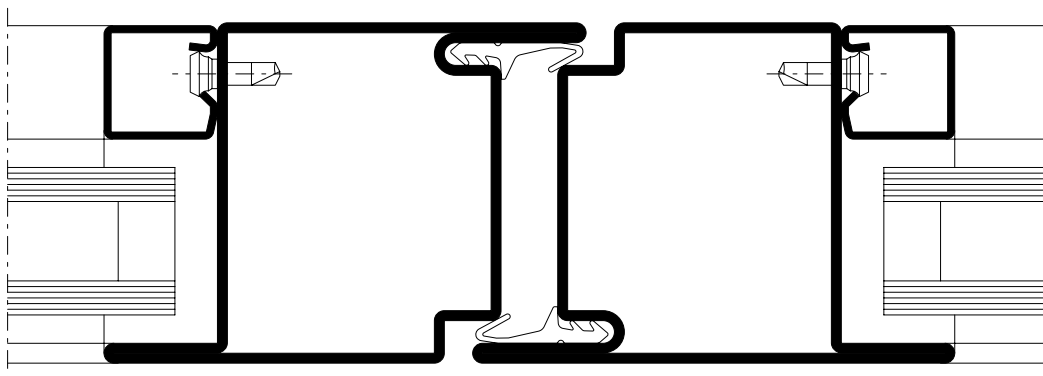

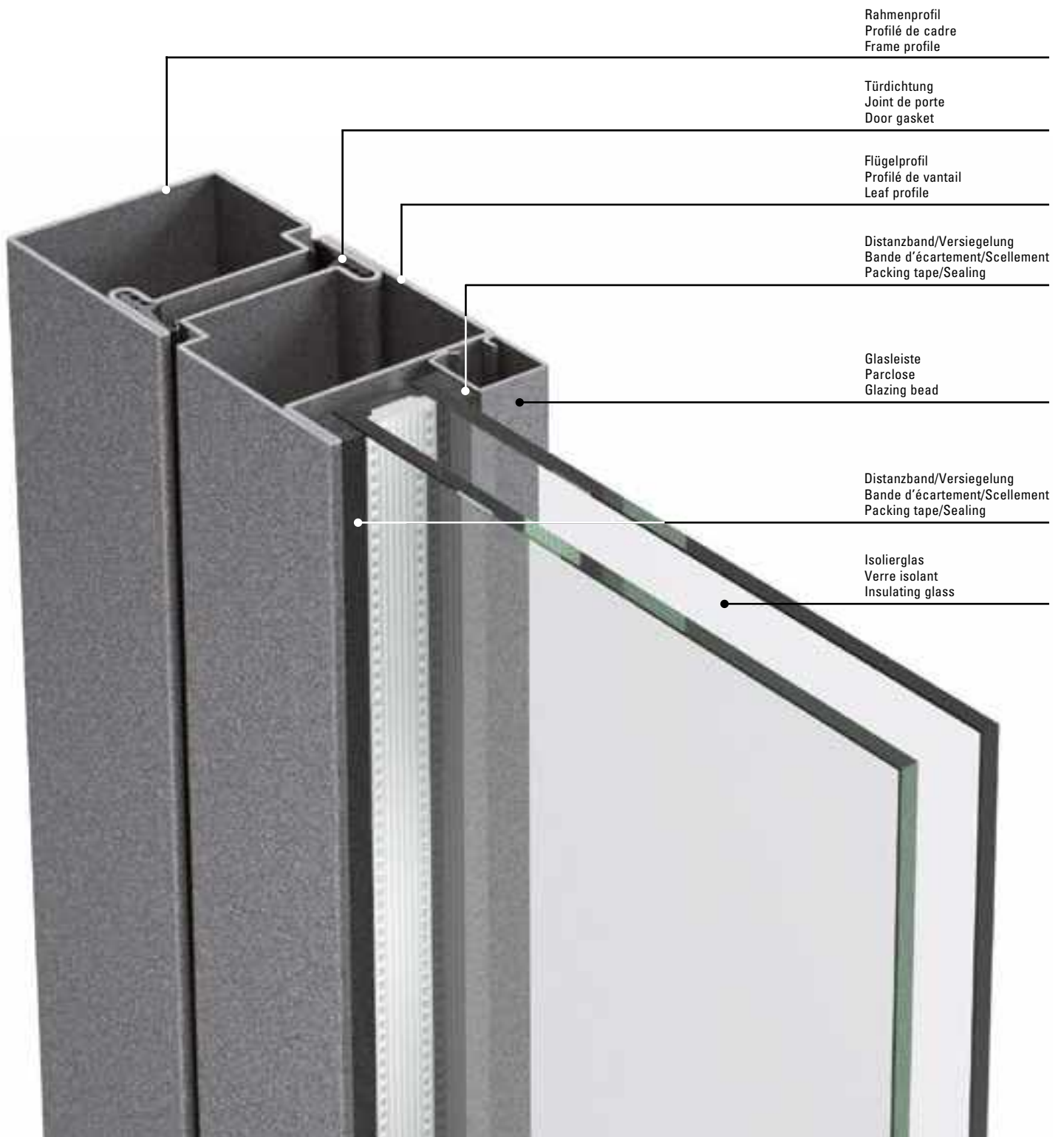

- Stahlsystem für Türen und Festverglasungen
- Bautiefe 60 mm, innen und aussen flächenbündig
- Schmale Ansichtsbreiten: Rahmen und Flügel ab 105 mm Stulppartie 150 mm
- Ein- und zweiflüglige Türen, nach innen und aussen öffnend, mit Oberlicht oder Festverglasung kombinierbar
- Türflügel bis 1465 x 3000 mm (BxH), Flügelgewicht bis 230 kg
- Füllelementstärke von 5 bis 36 mm, Glaseinbau mittels Trocken- oder Nassverglasung
- Systemprüfungen nach Produktnorm EN 14351-1
- Stahlprofile blank oder bandverzinkt
- Grosses Sortiment an systemgeprüften Türbeschlägen
- Barrierefreie Schwellenausbildungen
- Geeignet für Pulver- und Nasslackbeschichtungen





- Système en acier pour portes et vitrages fixes
- Profondeur de montage 60 mm, montage à fleur à l'intérieur et à l'extérieur
- Fines largeurs de face: Cadre et vantaux à partir de 105 mm Partie tête 150 mm
- Portes à un et deux vantaux, ouverture vers l'intérieur et vers l'extérieur, combinables avec imposte ou vitrage fixe
- Vantaux de porte jusqu'à 1465 x 3000 mm (LaxH), poids du vantail jusqu'à 230 kg
- Élément de remplissage de 5 à 36 mm d'épaisseur, Montage du vitrage à sec ou à silicone
- Contrôles des systèmes selon la norme produit EN 14351-1
- Profilés en acier brut ou galvanisé en continu
- Grand assortiment de ferrures de porte homologuées
- Formes de seuil sans barrière
- Convient aux revêtements par poudre ou peinture liquide

- Steel system for doors and fixed glazing
- 60 mm basic depth, flush-fitted on the inside and outside
- Narrow face widths: Frame and leaf from 105 mm Meeting stile assembly 150 mm
- Single and double-leaf doors, inward and outward-opening, can be combined with toplight or fixed glazing
- Door leaf up to 1465 x 3000 mm (WxH), leaf weight up to 230 kg
- Infill unit thickness of 5 to 36 mm, Glazing installed by means of dry or wet glazing
- System tests in accordance with the product standard EN 14351-1
- Raw finish or pre-galvanised steel profiles
- Large range of system-tested door fittings
- Easy-access thresholds
- Suitable for powder and wet paint coating





Norm	Eigenschaft Caractéristique Characteristic	Klassifizierung/Wert Classification / Valeur Classification / Value											
 EN 12210	<b>Widerstandsfähigkeit bei Windlast</b> <b>Résistance à la pression du vent</b> <b>Resistance to wind load</b>	npd	1 (400)	2 (800)	3 (1200)	4 (1600)	5 (2000)	Exxx (>2000)					
 EN 12208	<b>Schlagregendichtheit</b> <b>Étanchéité à la pluie battante</b> <b>Watertightness</b>	npd	1A (0)	2A (50)	3A (100)	4A (150)	5A (200)	6A (250)	7A (300)	8A (450)	9A (600)	Exxx (>750)	
 EN ISO 10140	<b>Schalldämmung</b> $R_w$ (C, $C_{tr}$ ) (dB) <b>Isolation phonique</b> $R_w$ (C, $C_{tr}$ ) (dB) <b>Sound insulation</b> $R_w$ (C, $C_{tr}$ ) (dB)	npd	bis $R_w$ 44 dB (-2; -5) jusqu'à $R_w$ 44 dB (-2; -5) up to $R_w$ 44 dB (-2; -5)										
 EN ISO 10077-2	<b>Wärmedurchgangskoeffizient</b> $U_f$ (W/(m <sup>2</sup> ·K)) <b>Transmission thermique</b> $U_f$ (W/(m <sup>2</sup> ·K)) <b>Thermal production</b> $U_f$ (W/(m <sup>2</sup> ·K))	npd	ab 5.65 W/m <sup>2</sup> K à partir de 5.65 W/m <sup>2</sup> K from 5.65 W/m <sup>2</sup> K										
 EN 12207	<b>Luftdurchlässigkeit</b> <b>Perméabilité à l'air</b> <b>Air permeability</b>	npd	1 (150)		2 (300)		3 (600)		4 (600)				
 EN 1192	<b>Klassifizierung der Festigkeitsanforderungen</b> <b>Classification des exigences de résistance méc.</b> <b>Classification of strength requirements</b>	npd	1		2		3		4				
 EN 1627	<b>Einbruchhemmung</b> <b>Anti-effraction</b> <b>Burglar resistance</b>	npd	1		2		3		4		5		6
 EN 1522	<b>Durchschusshemmung</b> <b>Résistance aux balles</b> <b>Bullet proofing</b>	npd	FB1	FB2	FB3	FB4	FB5	FB6	FB7	FSG			
 EN 1191 EN 1603	<b>Dauerfunktionsprüfung</b> <b>Durabilité mécanique</b> <b>Mechanical durability</b>	D	1 5'000	2 10'000	3 20'000	4 50'000	5 100'000	6 200'000	7 500'000	8 1'000'000			
 EN 179 EN 1125	<b>Fähigkeit zur Freigabe</b> <b>Capacité au déclenchement</b> <b>Ability to release</b>		Anforderung erfüllt Exigence remplie Requirement fulfilled										

Norm	Eigenschaft Caractéristique Characteristic	Klassifizierung/Wert Classification / Valeur Classification / Value			
 EN 12217	<b>Bedienkräfte</b> <b>Forces de manœuvre</b> <b>Operating forces</b>	npd	0	1	2
 EN 1634-3 DIN 18095	<b>Rauchschutz</b> <b>Etanchéité à la fumée</b> <b>Smoke control</b>	S <sub>a</sub> / S <sub>200</sub> / RS			
 EN 16034 EN 13501-2	<b>Selbstschliessung</b> <b>Fermeture automatique</b> <b>Self-closing</b>	C			
 EN 16034	<b>Dauerhaftigkeit der Selbstschliessung gegenüber Alterung (Korrosion)</b> <b>Endurance de la fermeture automatique contre le vieillissement (corrosion)</b> <b>Durability of self-closing against ageing (corrosion)</b>	erzielt atteinte achieved			



### Einbruchhemmende Jansen-Economy 60 Türen

- Türflügelgrößen 1465 x 3000 mm
- Ein- und zweiflügelige Türen, nach innen und aussen öffnend
- Geprüft nach EN 1627
- Panik- und Normalausführung

### Portes anti-effraction Jansen-Economy 60

- Dimensions de vantail de porte 1465 x 3000 mm
- Portes à un/deux vantaux à ouverture vers l'intérieur et l'extérieur
- Contrôlé selon la norme EN 1627
- Exécution panique et exécution normale

### Burglar-resistant Jansen Economy 60 doors

- Door leaf sizes 1465 x 3000 mm
- Single and double-leaf doors, inward and outward opening
- Tested in accordance with EN 1627
- Panic and standard design



### Durchschusshemmende Jansen-Economy 60 Türen

- Türflügelgrößen 1465 x 3000 mm
- Ein- und zweiflügelige Türen, nach innen und aussen öffnend
- Geprüft nach EN 1522

### Portes pare-balles Jansen-Economy 60

- Dimensions de vantail de porte 1465 x 3000 mm
- Portes à un/deux vantaux à ouverture vers l'intérieur et l'extérieur
- Contrôlé selon la norme EN 1522

### Bullet-resistant Jansen Economy 60 doors

- Door leaf sizes 1465 x 3000 mm
- Single and double-leaf doors, inward and outward opening
- Tested in accordance with EN 1522



### **Fluchttürsysteme**

- Verschlussystem für Notausgangstüren nach EN 179
- Verschlussystem für Paniktüren nach EN 1125
- Barrierefreie Türen ohne Schwelle für behindertengerechtes Bauen
- Ein- und zweiflügelige Türen nach innen und aussen öffnend
- Türflügelgrößen bis 1465 x 3000 mm und Flügelgewicht bis 230 kg

### **Systèmes de porte de secours**

- Système de fermeture pour portes de secours selon EN 179
- Système de fermeture pour portes panique selon EN 1125
- Portes sans seuil pour faciliter l'accès aux personnes handicapées
- Portes à un/deux vantaux à ouverture vers l'intérieur et l'extérieur
- Dimensions de vantail de porte jusqu'à 1465 x 3000 mm et poids de vantail jusqu'à 230 kg

### **Emergency exit systems**

- Closing system for emergency exit doors in accordance with EN 179
- Closing system for panic doors in accordance with EN 1125
- Barrier-free doors without threshold for accessible buildings
- Single and double-leaf doors, inward and outward opening
- Door leaf sizes up to 1465 x 3000 mm and leaf weight up to 230 kg



### **Jansen-Economy 60 Fingerschutzüren**

- Keine Quetsch- und Scherstellen nach DIN 18650
- Wartungsarme Bandlager unten und oben
- Geeignet für Gebäude mit starkem Publikumsverkehr
- Geprüft nach EN 14351-1

### **Portes anti-pince-doigts Jansen-Economy 60**

- Absence de zones d'écrasement et de cisaillement selon DIN 18650
- Paliers de paumelle inférieur et supérieur exigeant peu de maintenance
- Adapté à des bâtiments publics fortement fréquentés
- Contrôlé selon la norme EN 14351-1

### **Jansen Economy 60 anti-finger-trap doors**

- No crushing and shearing points as per DIN 18650
- Low-maintenance hinge bush at top and bottom
- Suitable for buildings subject to frequent use by the public
- Tested in accordance with EN 14351-1



### Verblechte Jansen-Economy 60 Türen

- Flächenbündig verblechte Türen
- Geschweisst oder geklebt
- Nach innen und aussen öffnend
- Mit Glasausschnitt möglich

### Portes tôlées Jansen-Economy 60

- Portes tôlées à fleur
- Soudées ou collées
- Ouverture vers l'intérieur et l'extérieur
- Panneau de verre possible

### Jansen Economy 60 sheet metal doors

- Flush-fitted sheet metal doors
- Welded or bonded
- Inward and outward-opening
- Can have glass vision panel



### Jansen-Economy 60 Faltwand

- Nach innen und aussen öffnend
- Leichtgängige, geräuscharme Bedienung
- Schwellenlose Ausführung
- Flügelgewichte bis 100 kg

### Porte repliable Jansen-Economy 60

- Ouverture vers l'intérieur et l'extérieur
- Mobilité silencieuse
- Exécution sans seuil
- Poids de vantail jusqu'à 100 kg

### Jansen Economy 60 folding wall

- Inward and outward-opening
- Smooth and quiet operation
- Design without a threshold
- Vent weights up to 100 kg



## Jansen Docu Center

Die Plattform zum effizienten Arbeiten mit Jansen Dokumentationen. Im Jansen Docu Center stehen alle Produktinformationen jederzeit digital in der aktuellsten Version zur Verfügung: von Architekten-Informationen über Bestell- und Fertigungskatalogen bis hin zu Anleitungen und Prospekten sowie Videos.

Die Inhalte können einfach und schnell aufgerufen werden. Ein für den Anwender komfortables papierloses Arbeiten, das zahlreiche Vorteile bietet.

## Download CAD Daten

**DXF**

**DWG**

Sie können die Zeichnungen in den Formaten DXF und/oder DWG herunterladen. Klicken Sie auf das entsprechende Icon und der Download erfolgt.

Die Hinweise «Artikelbibliothek/Türbeschläge/Fensterbeschläge» bedeuten, dass Sie mit einem Klick die gesamte Artikelbibliothek des entsprechenden Systems herunterladen (Profile, Beschläge, Glasleisten, Zubehör etc.).

## Info und Beratung

Gerne beraten wir Sie persönlich und stehen Ihnen bei Fragen zur Verfügung. Bitte schreiben Sie uns Ihre Anliegen an: [info@jansen.com](mailto:info@jansen.com)

## Jansen Docu Center

La plate-forme pour travailler efficacement avec les documentations Jansen. Le Jansen Docu Center met à votre disposition les informations sur les produits, en format numérique et dans une version actualisée: des catalogues de commande et de fabrication aux instructions et prospectus, en passant par les informations destinées aux architectes et vidéos.

Les contenus sont facilement et rapidement accessibles. Une manière de travailler confortable et offrant de nombreux avantages.

## Télécharger fichiers DAO

**DXF**

**DWG**

Vous pouvez télécharger les dessins aux formats DXF et/ou DWG. Cliquez sur l'icône correspondante et le téléchargement s'effectuera.

Les indications «Bibliothèque des articles/Ferures de porte/Ferrures de fenêtres» signifie que vous téléchargez la totalité de la bibliothèque des articles du système donné (profilés, ferrures, parclofes, accessoires etc.).

## Info et conseils

Nous vous conseillerons volontiers individuellement et sommes à votre disposition si vous avez des questions à poser. Veuillez nous envoyer votre requête à: [info@jansen.com](mailto:info@jansen.com)

## Jansen Docu Center

The platform for working efficiently with Jansen documentation. The latest version of all the product information is available digitally at any time in the Jansen Docu Center – from order and fabrication manuals to architect information, instructions and brochures and videos.

The content can be retrieved quickly and easily. The user can work conveniently without paper, which has numerous benefits.

## Download CAD files

**DXF**

**DWG**

You can download the drawings in DXF and/or DWG format. Click on the relevant icon to begin the download.

The items «Article library/Door fittings/Window fittings» means that you download the entire article library for the corresponding system with one click (profiles, fittings, glazing beads, accessories etc.).

## Information and advice

We would be delighted to provide you with advice in person and are available to answer any questions you may have. Please write to us with your queries at: [info@jansen.com](mailto:info@jansen.com)

Zulassungen/Prüfungen  
Homologations/Essais  
Authorisations/Tests

Jansen-Economy 60 Türen  
Jansen-Economy 60 portes  
Jansen-Economy 60 doors

Elementgrößen  
(Empfehlung für CE-Kennzeichnung)

Dimensions des éléments  
(Recommandation pour le label CE)

Size of elements  
(Recommendation for CE marking)

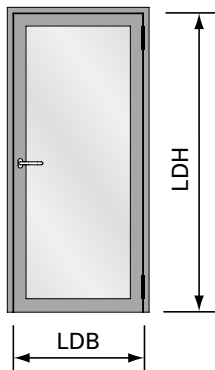

LDB Lichte Durchgangsbreite  
max. 1400 mm  
min. 490 mm

LDB Largeur vide lumière  
max. 1400 mm  
min. 490 mm

LDB Clear opening width  
max. 1400 mm  
min. 490 mm

LDH Lichte Durchgangshöhe  
max. 3000 mm  
min. 1900 mm

LDH Hauteur vide lumière  
max. 3000 mm  
min. 1900 mm

LDH Clear opening height  
max. 3000 mm  
min. 1900 mm

Flügelgewicht max. 230 kg

Poids de vantail max. 230 kg

Weight of leaf max. 230 kg

Zulassungen/Prüfungen  
Homologations/Essais  
Authorisations/Tests

Jansen-Economy 60 Türen  
Jansen-Economy 60 portes  
Jansen-Economy 60 doors

Elementgrößen  
(Empfehlung für CE-Kennzeichnung)

Dimensions des éléments  
(Recommandation pour le label CE)

Size of elements  
(Recommendation for CE marking)

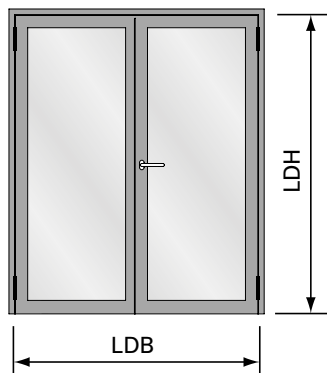

LDB Lichte Durchgangsbreite  
max. 2800 mm  
min. 1000 mm

LDB Largeur vide lumière  
max. 2800 mm  
min. 1200 mm

LDB Clear opening width  
max. 2800 mm  
min. 1000 mm

LDH Lichte Durchgangshöhe  
max. 3000 mm  
min. 1900 mm

LDH Hauteur vide lumière  
max. 3000 mm  
min. 1900 mm

LDH Clear opening height  
max. 3000 mm  
min. 1900 mm

Flügelgewicht max. 230 kg

Poids de vantail max. 230 kg

Weight of leaf max. 230 kg

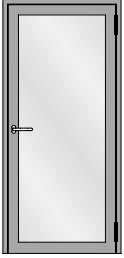

Einflügelige Türe  
Porte à un vantail  
Single leaf door

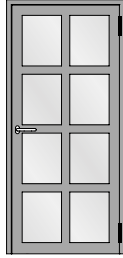

Einflügelige Türe mit Riegel  
Porte à un vantail avec traverse  
Single leaf door with transom

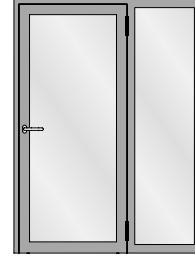

Einflügelige Türe mit Seitenteil  
Porte à un vantail avec partie latérale  
Single leaf door with side light

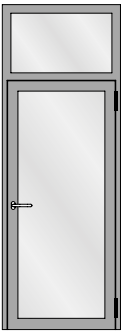

Einflügelige Türe mit Oberlicht  
Porte à un vantail avec imposte  
Single leaf door with top light

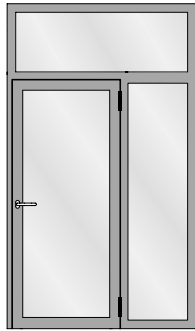

Einflügelige Türe mit Seitenteil und Oberlicht  
Porte à un vantail avec avec partie latérale  
et imposte  
Single leaf door with side light and top light

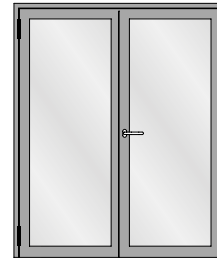

Zweiflügelige Türe  
Porte à deux vantaux  
Double leaf door

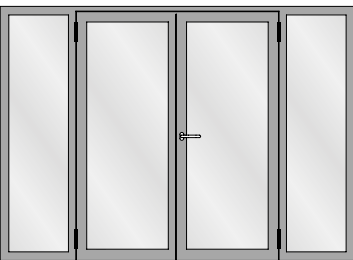

Zweiflügelige Türe mit zwei Seitenteilen  
Porte à deux vantaux avec deux parties latérales  
Double leaf door with two side lights

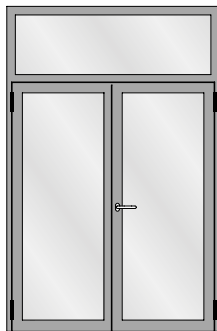

Zweiflügelige Türe mit Oberlicht  
Porte à deux vantaux avec imposte  
Double leaf door with top light

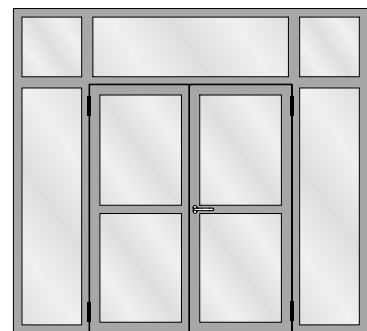

Zweiflügelige Türe mit zwei Seitenteilen und Oberlichtern  
Porte à deux vantaux avec deux parties latérales et impostes  
Double leaf door with two side lights and top lights

**Typenübersicht**  
**Sommaire des types**  
**Summary of types**

**Jansen-Economy 60 Türen**  
**Jansen-Economy 60 portes**  
**Jansen-Economy 60 doors**

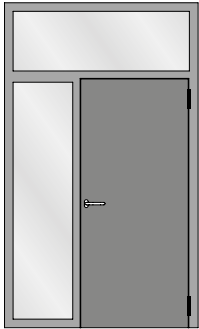

Verblechte Türe mit Seitenteil und Oberlicht  
 Porte tôlée à un vantail avec avec partie latérale et imposte  
 Sheet metal single leaf door with side light and top light



Verblechte zweiflügelige Türe mit zwei Seitenteilen und Oberlichtern  
 Porte tôlée à deux vantaux avec deux parties latérales et impostes  
 Sheet metal double leaf door with two side lights and top lights



Festverglasung  
 Vitrage fixe  
 Fixed glazing

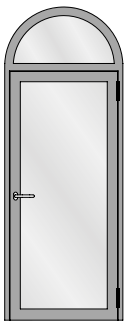

Einflügelige Türe mit Rundbogen-Oberlicht  
 Porte à un vantail avec imposte demi-ronde  
 Single leaf door with round arched top light

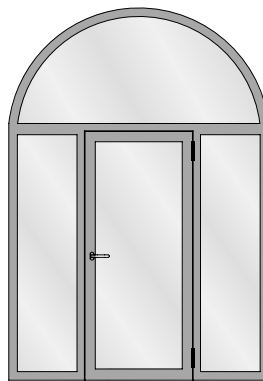

Einflügelige Türe mit zwei Seitenteilen und Rundbogen-Oberlicht  
 Porte à un vantail avec deux parties latérales et imposte demi-ronde  
 Single leaf door with two side lights and round arched top light

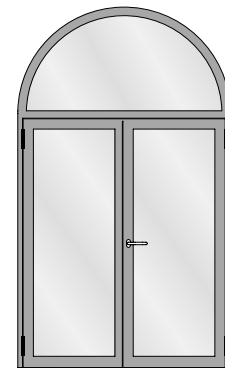

Zweiflügelige Türe mit Rundbogen-Oberlicht  
 Porte à deux vantaux avec imposte demi-ronde  
 Double leaf door with round arched top light

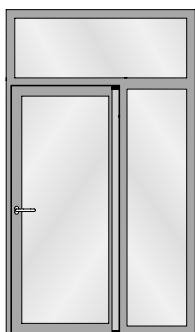

Fingerschutztüre  
 Porte anti-pince-doigts  
 Anti-finger-trap door

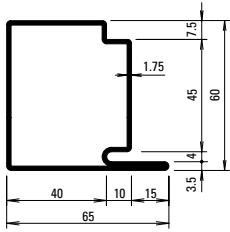

**30.019**  
**30.019 Z**

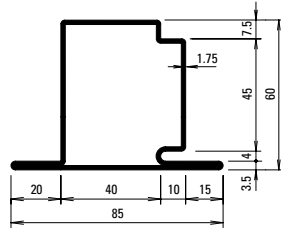

**30.119**  
**30.119 Z**

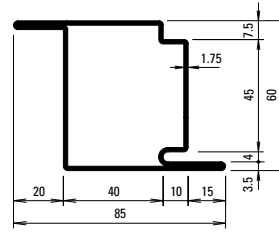

**30.419**  
**30.419 Z**

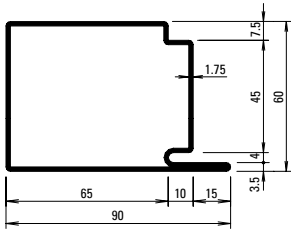

**30.017**  
**30.017 Z**

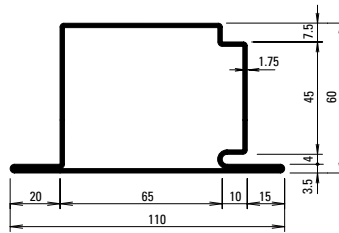

**30.117**  
**30.117 Z**

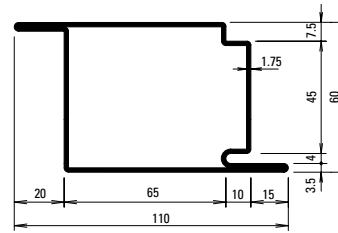

**30.415**

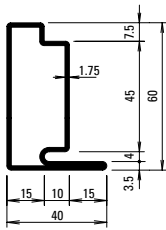

**30.018**  
**30.018 Z**

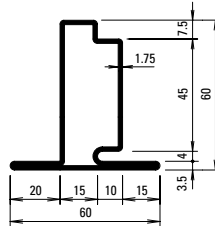

**30.118**  
**30.118 Z**

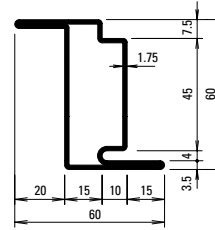

**30.418**  
**30.418 Z**

**Oberfläche/Werkstoff**

Artikel-Nr.

**ohne Zusatz** = blank

**mit Z** = bandverzinkter Stahl

**Surface/Matériau**

No. d'article

**sans supplément** = brut

**avec Z** = bande d'acier zinguée

**Surface/Material**

Part no.

**without addition** = bright

**with Z** = strip galvanised steel

Profil-Nr.	G kg/m	F cm <sup>2</sup>	I <sub>x</sub> cm <sup>4</sup>	W <sub>x</sub> cm <sup>3</sup>	I <sub>y</sub> cm <sup>4</sup>	W <sub>y</sub> cm <sup>3</sup>	U m <sup>2</sup> /m
<b>30.017</b>	4,200	5,36	31,32	9,09	48,57	10,35	0,312
<b>30.018</b>	2,830	3,61	15,95	4,35	4,77	1,93	0,212
<b>30.019</b>	3,520	4,48	23,69	6,70	19,75	5,55	0,262
<b>30.117</b>	4,750	6,04	34,75	9,35	65,74	11,51	0,350
<b>30.118</b>	3,370	4,29	18,64	4,65	8,26	2,75	0,250
<b>30.119</b>	4,050	5,16	26,80	6,99	29,12	6,58	0,300

Profil-Nr.	G kg/m	F cm <sup>2</sup>	I <sub>x</sub> cm <sup>4</sup>	W <sub>x</sub> cm <sup>3</sup>	I <sub>y</sub> cm <sup>4</sup>	W <sub>y</sub> cm <sup>3</sup>	U m <sup>2</sup> /m
<b>30.415</b>	4,750	6,04	37,79	12,28	65,74	11,51	0,350
<b>30.418</b>	3,370	4,29	22,92	7,37	8,62	2,75	0,250
<b>30.419</b>	4,050	5,16	30,36	9,82	29,12	6,58	0,300

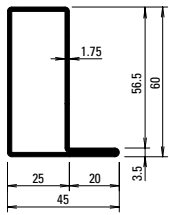

**01.634**  
**01.634 Z**

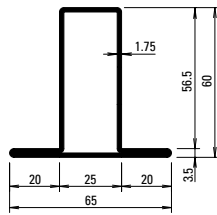

**02.634**  
**02.634 Z**

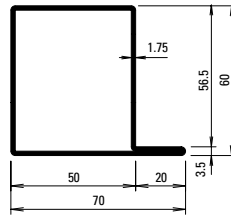

**01.684**  
**01.684 Z**

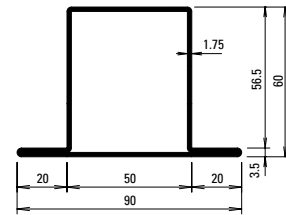

**02.684**  
**02.684 Z**

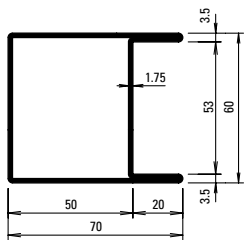

**04.637**  
**04.637 Z**

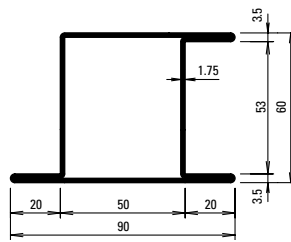

**05.637**  
**05.637 Z**

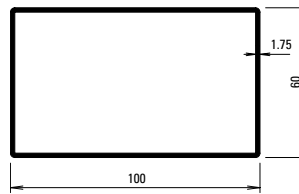

**400.051**  
**400.051 Z**

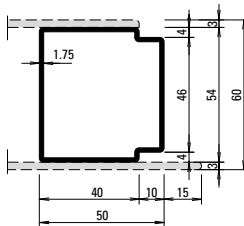

**81.010 Z**

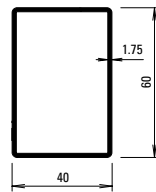

**400.052**  
**400.052 Z**

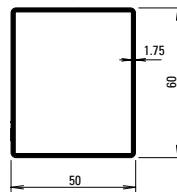

**400.054**  
**400.054 Z**

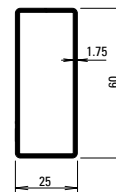

**400.055**  
**400.055 Z**

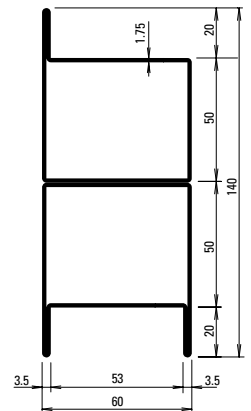

**05.001**

Profil-Nr.	G kg/m	F cm <sup>2</sup>	I <sub>x</sub> cm <sup>4</sup>	W <sub>x</sub> cm <sup>3</sup>	I <sub>y</sub> cm <sup>4</sup>	W <sub>y</sub> cm <sup>3</sup>	U m <sup>2</sup> /m
<b>01.634</b>	2,730	3,48	16,71	4,71	6,04	2,15	0,204
<b>02.634</b>	3,270	4,17	19,66	5,01	10,34	3,18	0,243
<b>01.684</b>	3,430	4,37	24,34	7,07	22,12	5,59	0,255
<b>02.684</b>	3,960	5,05	27,70	7,36	31,93	7,09	0,294
<b>04.637</b>	3,960	5,05	30,62	10,2	27,45	7,71	0,294
<b>05.637</b>	4,500	5,72	35,42	10,6	39,45	8,02	0,333
<b>81.010</b>	2,700	3,43	14,53	5,38	13,05	5,10	0,202
<b>400.051</b>	4,300	5,44	76,01	15,2	34,64	11,55	0,316
<b>400.052</b>	2,630	3,34	8,98	4,49	16,86	5,62	0,197
<b>400.054</b>	2,900	3,69	14,97	5,98	19,83	6,61	0,217
<b>400.055</b>	2,210	2,82	3,08	2,47	12,41	4,13	0,167

**Stabachse**  
**Axe de la barre**  
**Bar axis**

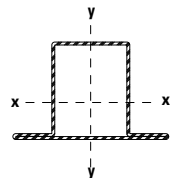

Artikelbibliothek  
 Bibliothèque des articles  
 Article library

**DXF** **DWG**

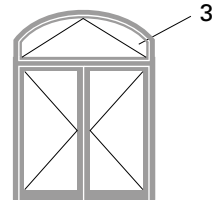
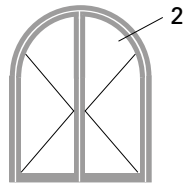
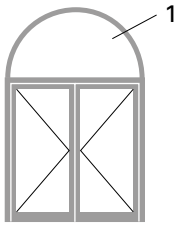

**1.0**

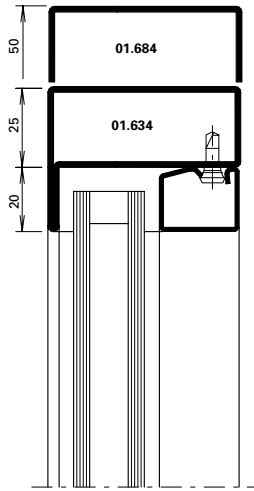

**2.0**

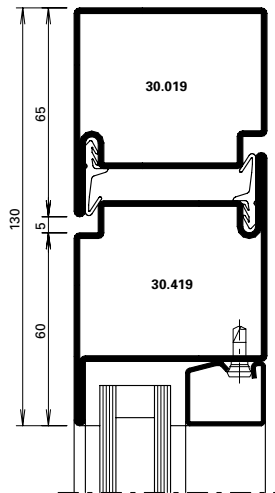

**3.0**

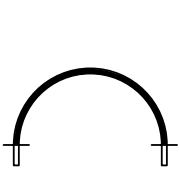
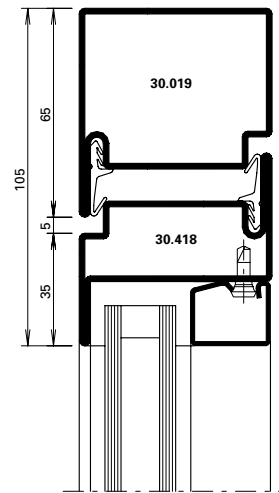

Halbrundbogen  
 Arc semi-circulaire  
 Semi-circular arch

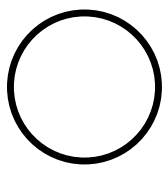

Rundbogen  
 Arc en plein centre  
 Round arch

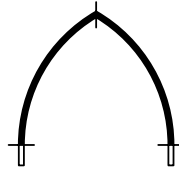

Spitzbogen  
 Ogive  
 Gothic arch



Stichbogen  
 Arc bombé  
 Segmented arch



Korbbogen  
 Anse de panier  
 Oval arch

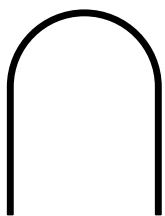

Halbrundbogen mit Schenkel  
 Arc surhaussé  
 Semi-circular arch with side extension

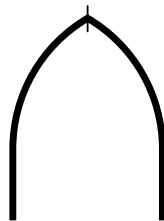

Spitzbogen mit Schenkel  
 Arc en ogive  
 Gothic arch with side extension

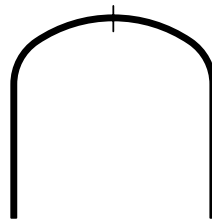

Korbbogen mit Schenkel  
 Anse de panier prolongée  
 Oval arch with side extension





**Bogentüren**  
**Portes cintrées**  
**Arched doors**

Jansen-Economy 60 Türen  
 Jansen-Economy 60 portes  
 Jansen-Economy 60 doors

Profil Profilé Profile	Min. Radius Rayon min. Min. radius R	
------------------------------	---	--

	blank brut bright	verzinkt zinguée galvanised
	mm	mm
01.634	550	550
01.684	650	650

		
02.634	600	650
02.684	1050	1050

		
04.637	1550	1550

		
05.637	1550	1550

		
400.052	1100	1100
400.054	1000	1000
400.055	800	800
81.010		800

Profil Profilé Profile	Min. Radius Rayon min. Min. radius R	
------------------------------	---	--

	blank brut bright	verzinkt zinguée galvanised
	mm	mm
30.018		550
30.019	650	650

		
30.118	800	800
30.119	900	900

		
30.418	800	800
30.419	1100	1100

Stahl-Glasleisten Parcloses en acier Steel glazing beads	Min. Radius Rayon min. Min. radius R
--	---

	
62.507 Z	300 mm
62.508 Z	300 mm
62.509 Z	300 mm

Stahl-Glasleisten Parcloses en acier Steel glazing beads	Min. Radius Rayon min. Min. radius R
--	---

	
402.112 Z	500 mm
402.115 Z	500 mm
402.120 Z	600 mm
402.125 Z	750 mm
402.130 Z	1000 mm
402.135 Z	1500 mm

Aluminium-Glasleisten Parcloses en aluminium Aluminium glazing beads	Min. Radius Rayon min. Min. radius R
--	---

	
404.109	400 mm
404.112	400 mm
404.115	400 mm
404.120	400 mm
404.125	450 mm
404.130	500 mm
404.135	600 mm

	
405.110	500 mm
405.115	500 mm
405.120	500 mm
405.125	800 mm
405.130	1000 mm
406.903	500 mm
406.905	500 mm
406.907	500 mm
406.909	600 mm

Die Radien-Angaben beziehen sich auf die langjährige Erfahrung und Fertigung im Hause Jansen.

Les rayons indiqués se fondent sur la longue expérience et la fabrication au sein de la maison Jansen.

The radii specifications are based on the many years of experience Jansen has in fabrication.

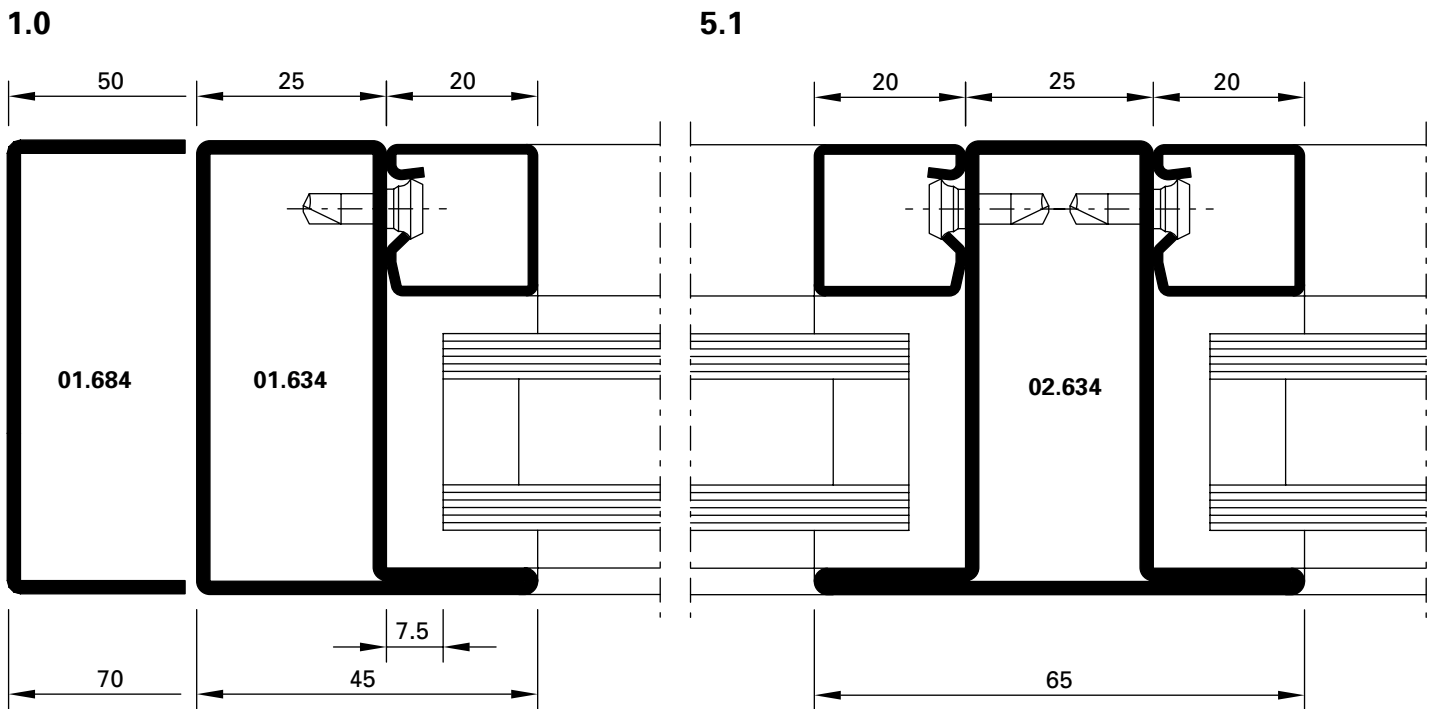
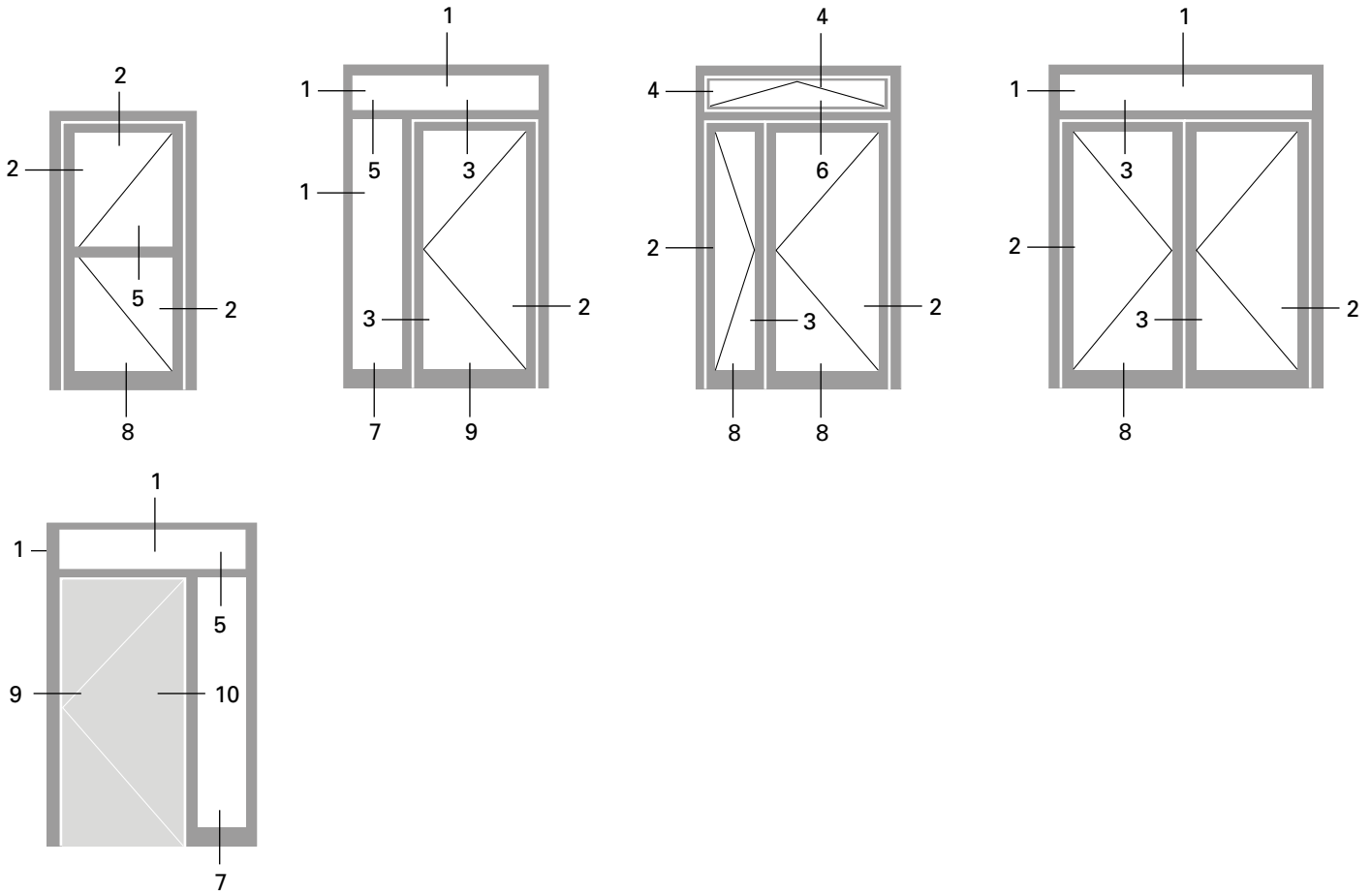

**DXF** **DWG** D-250-C-001

**DXF** **DWG** D-250-C-032

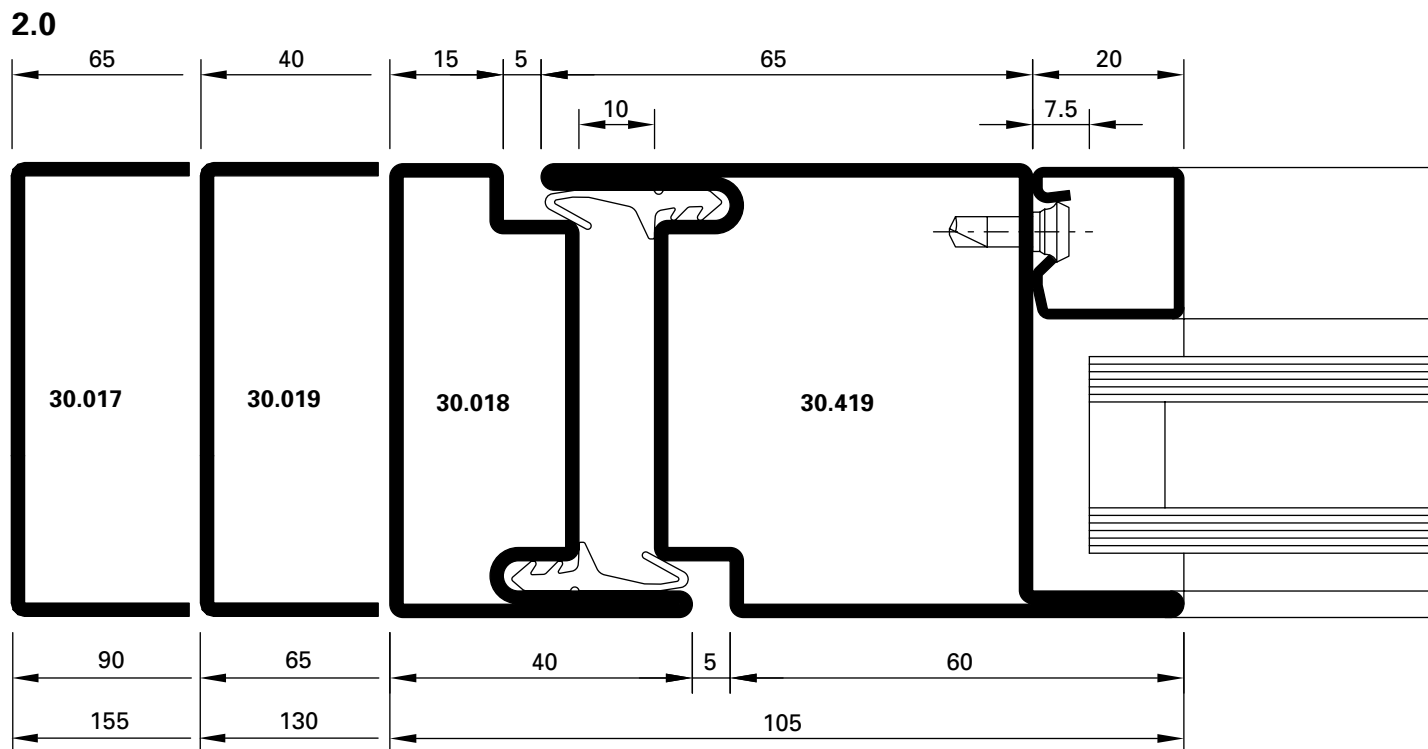

**DXF** **DWG** D-250-C-002

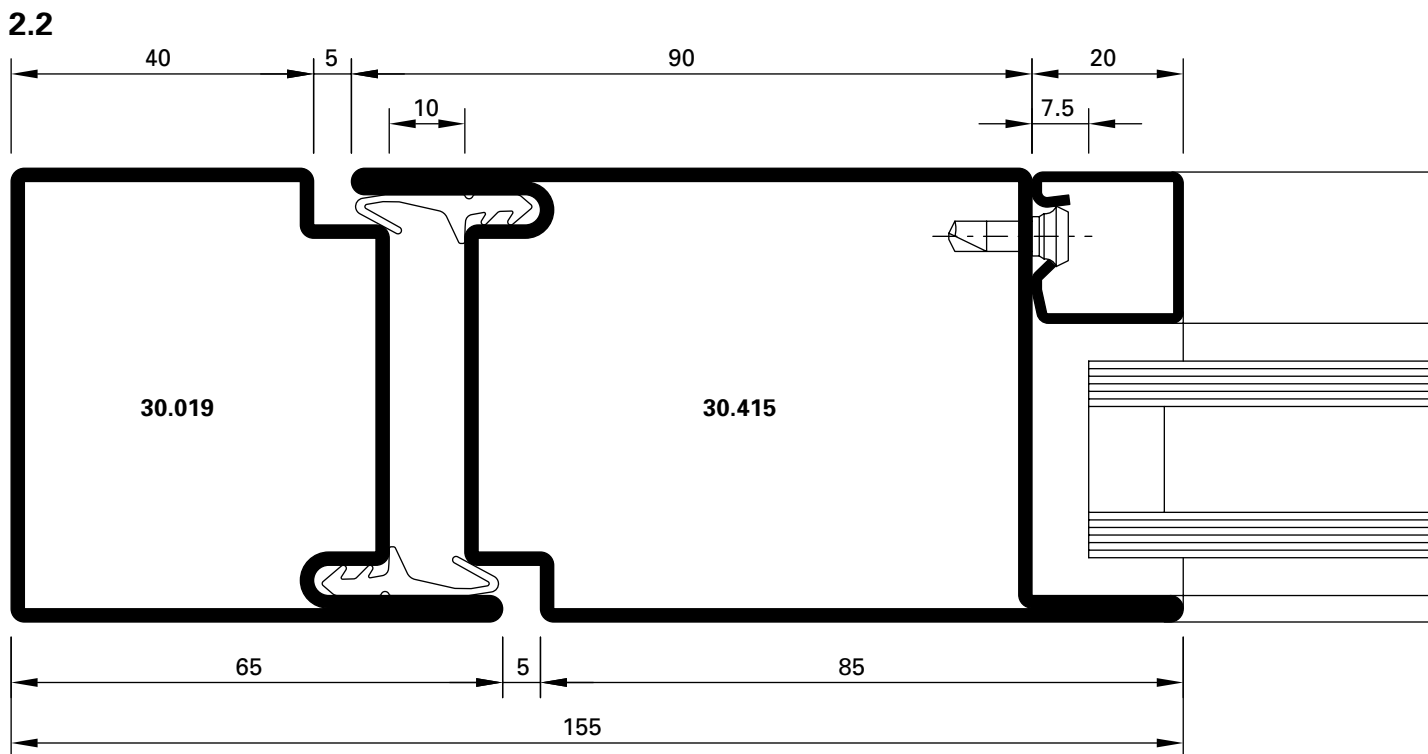

**DXF** **DWG** D-250-C-005

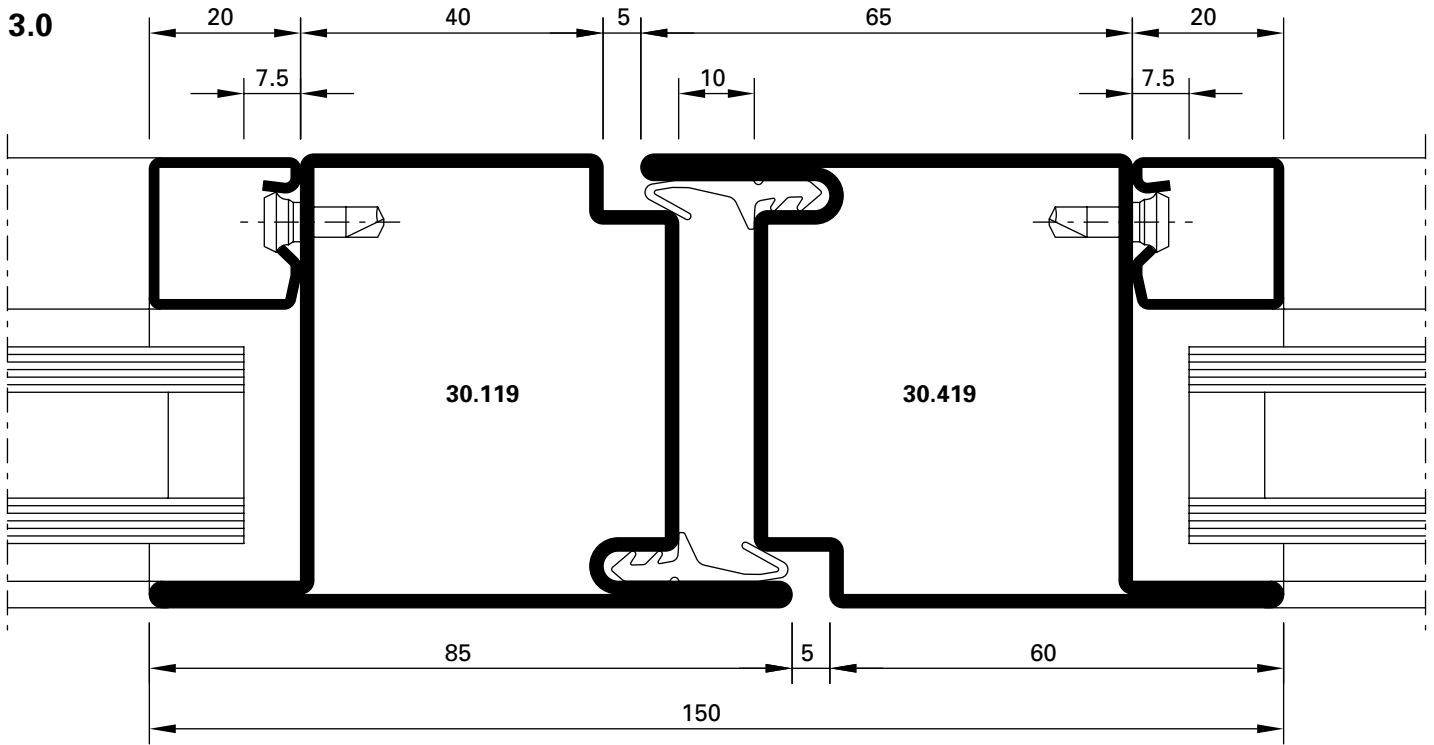

DXF DWG D-250-C-003

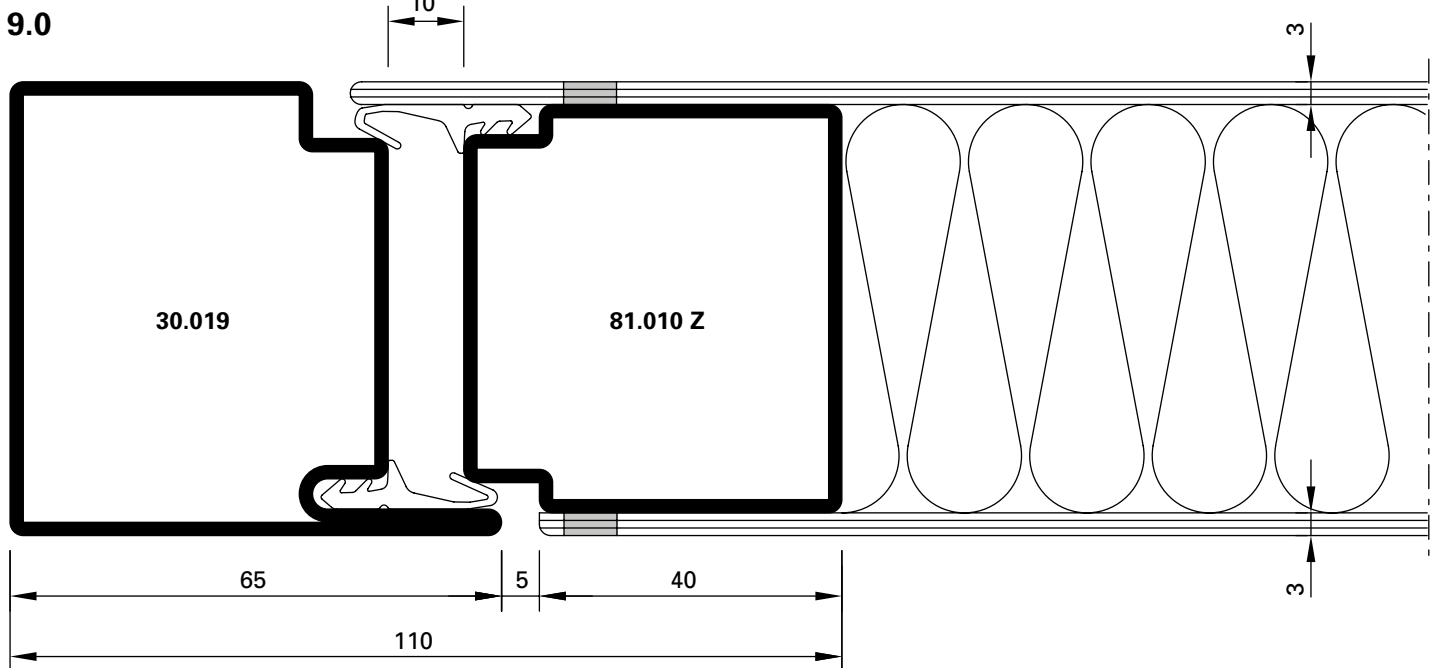

DXF DWG D-250-C-013

4.0

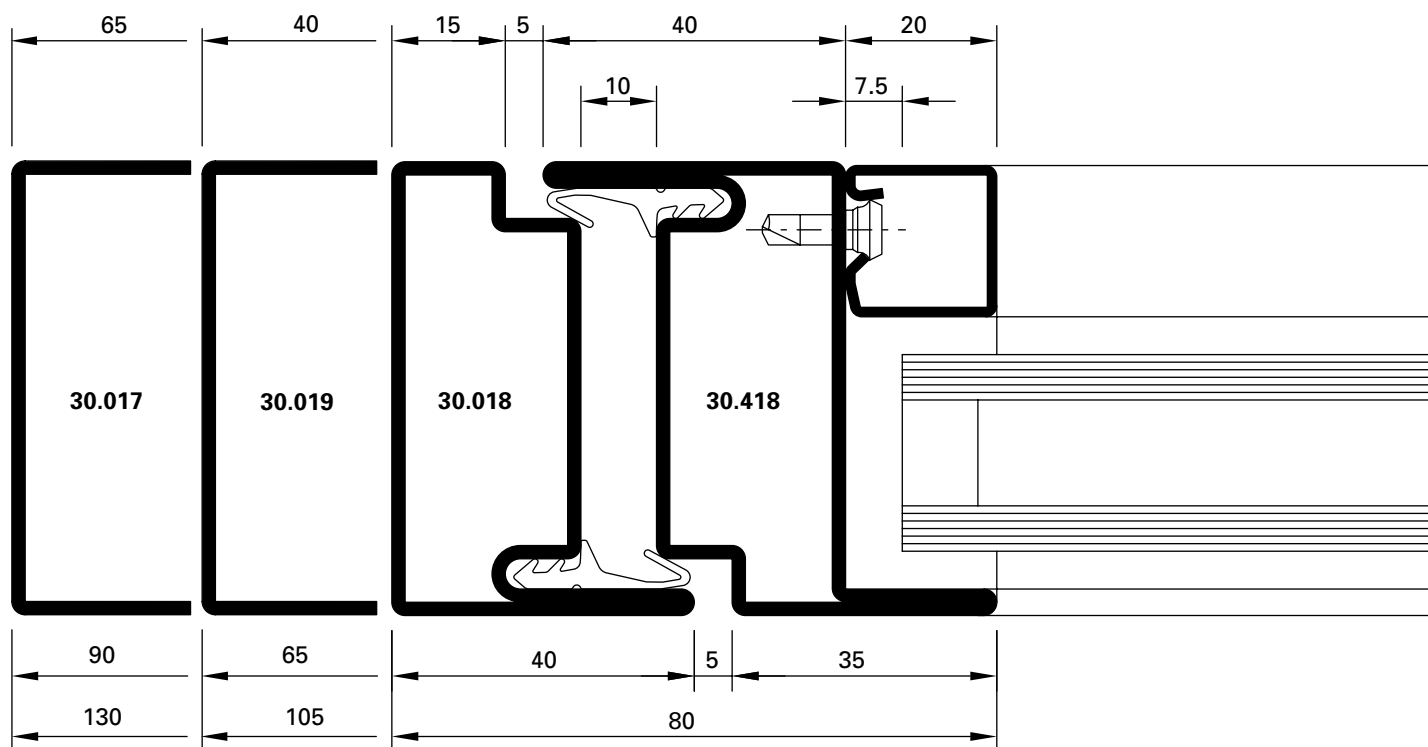

**DXF** **DWG** D-250-C-010

5.0

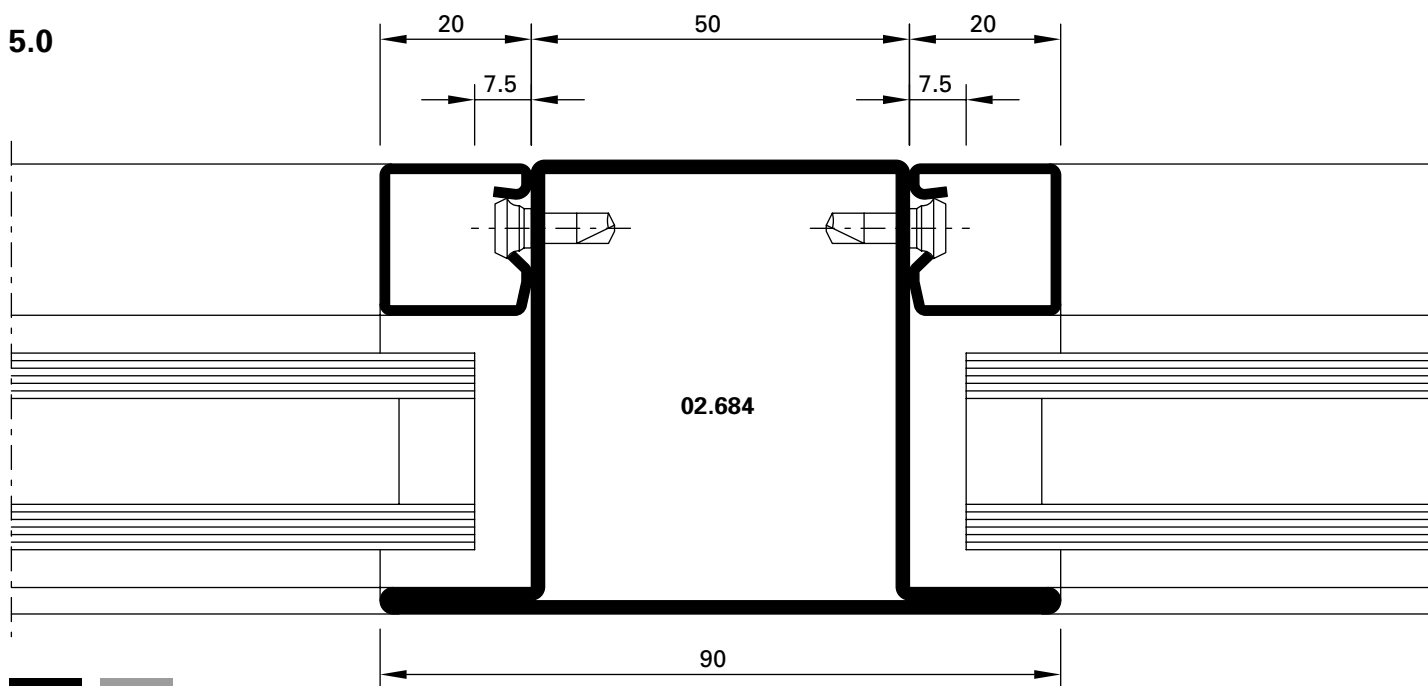

**DXF** **DWG** D-250-C-012

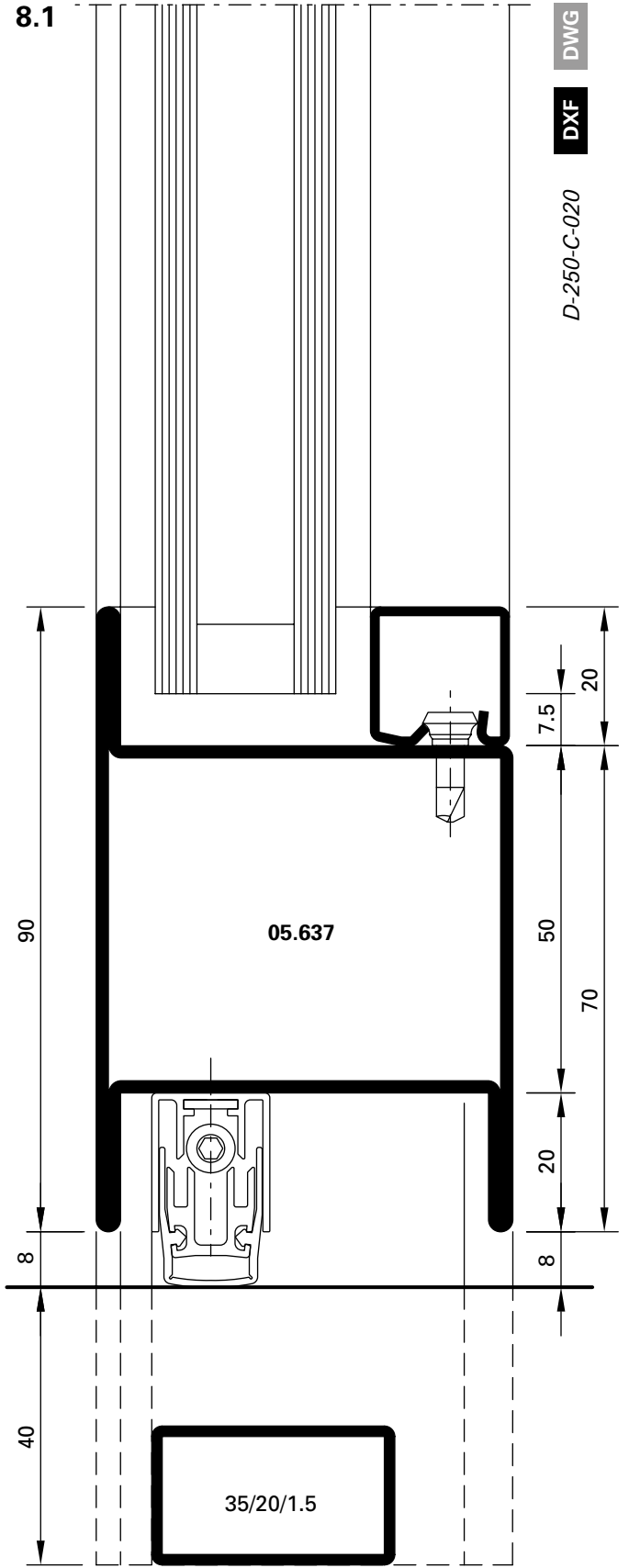
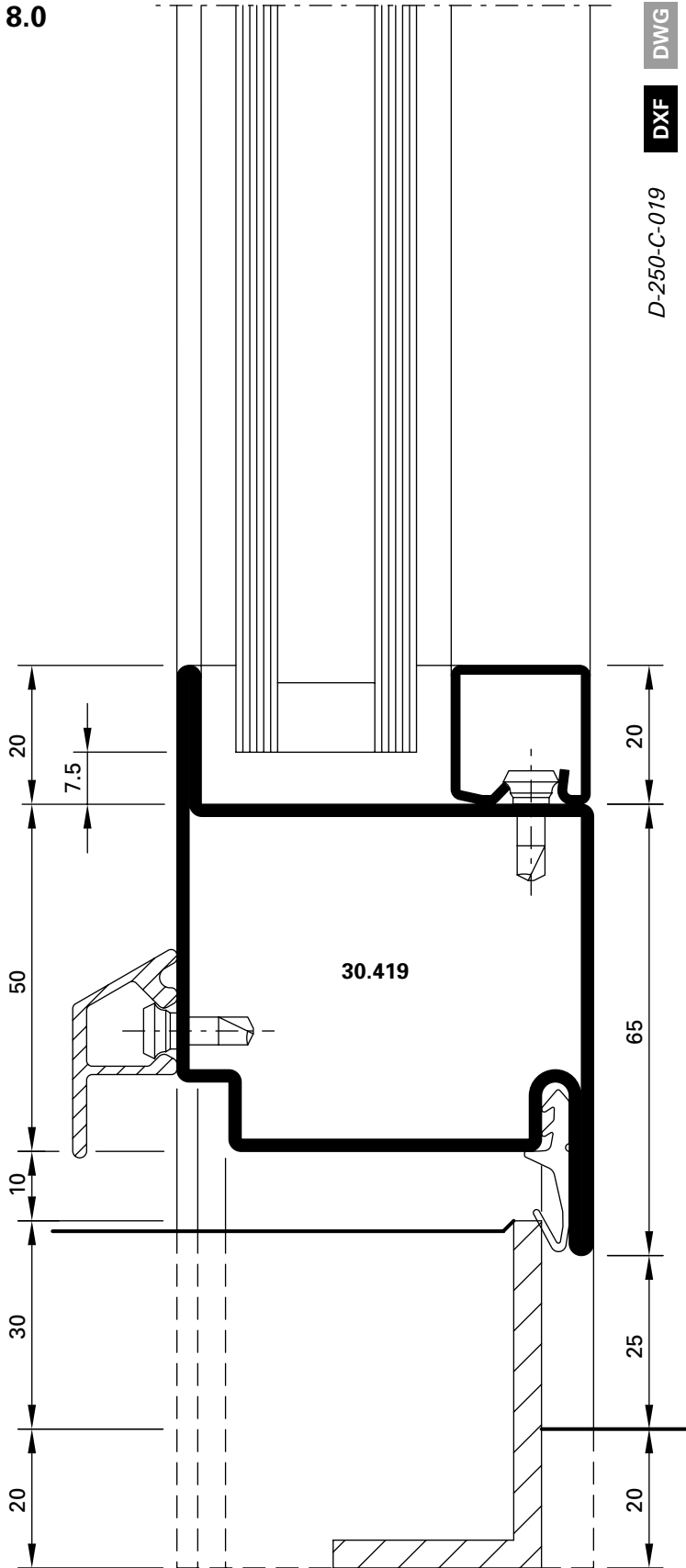

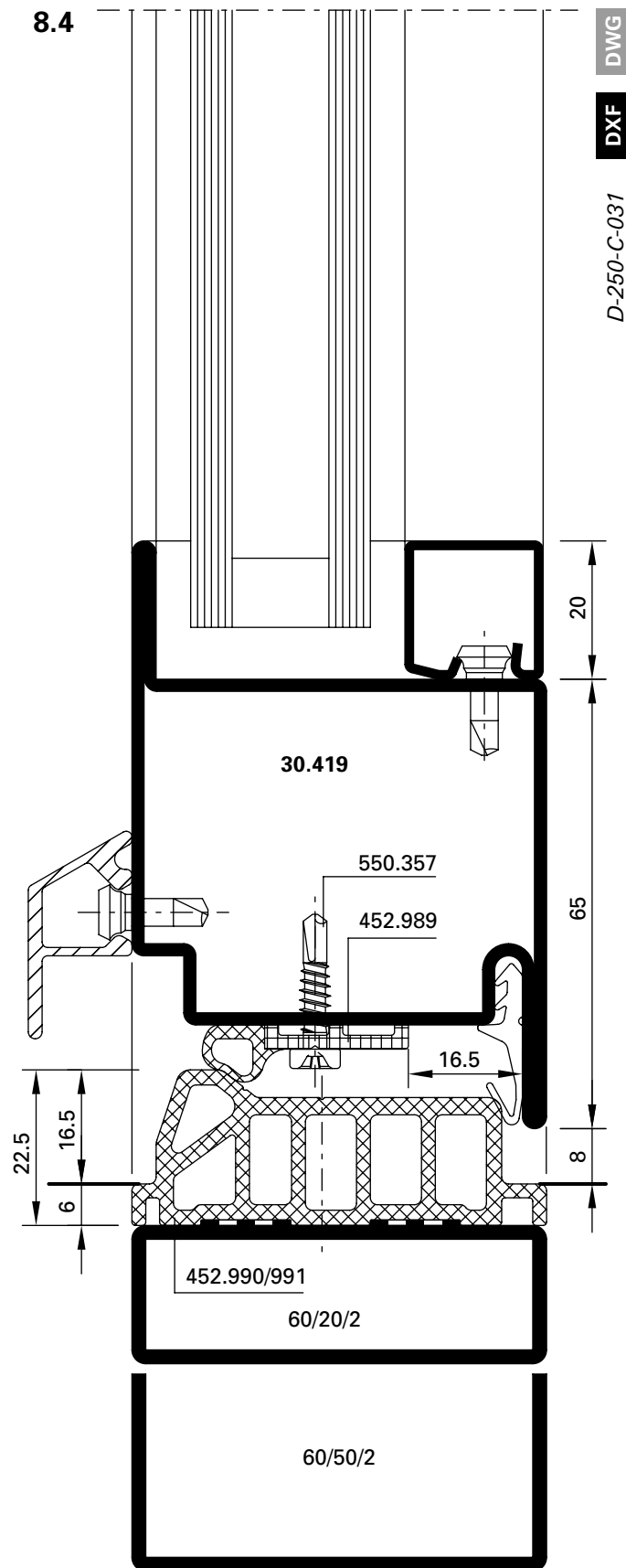
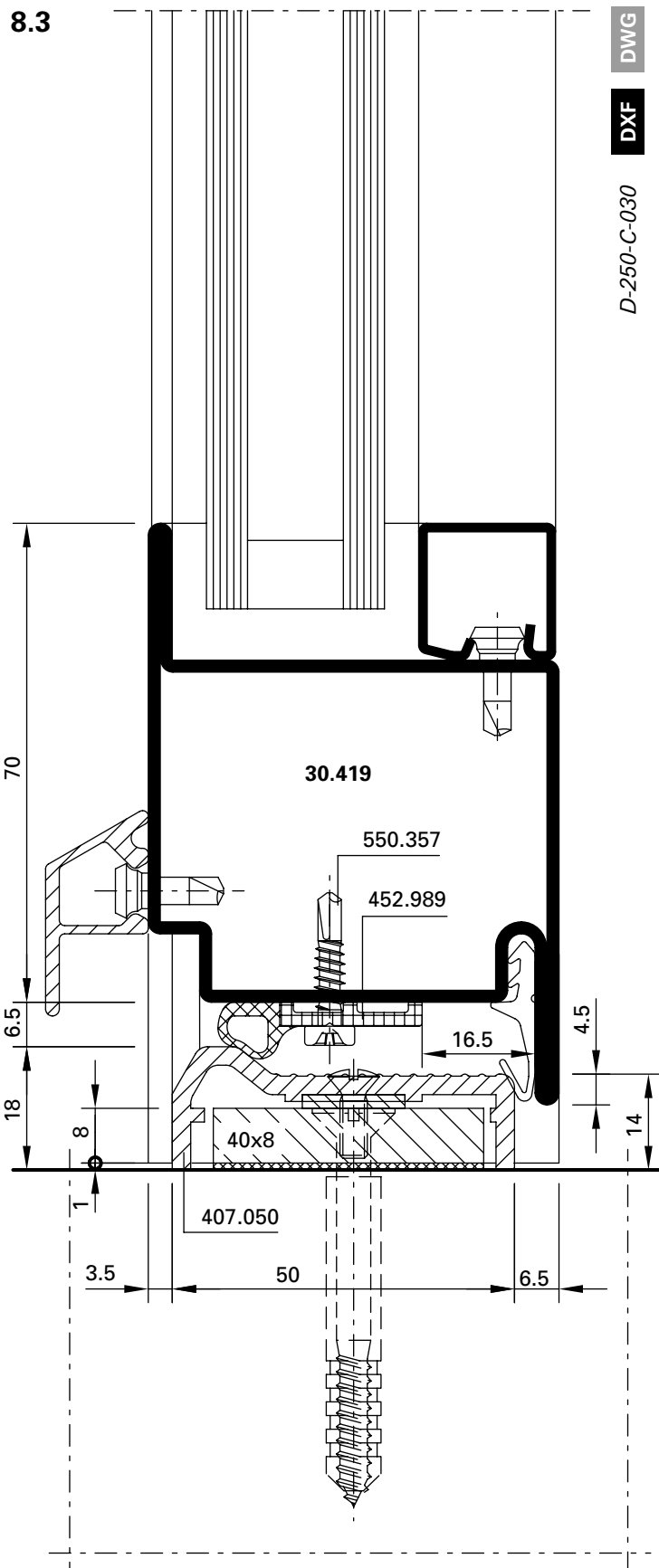

2.1

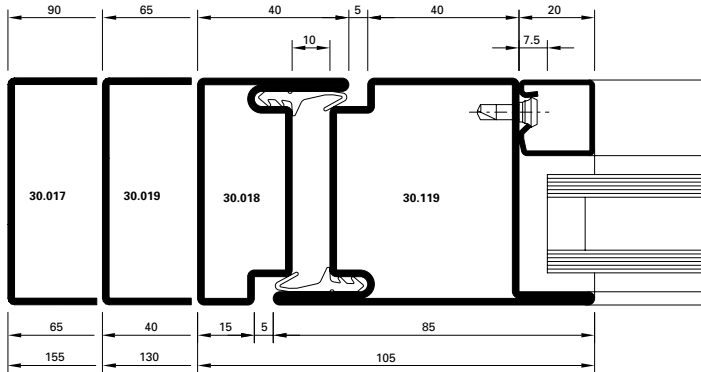

**DXF** **DWG** *D-250-C-004*

2.3

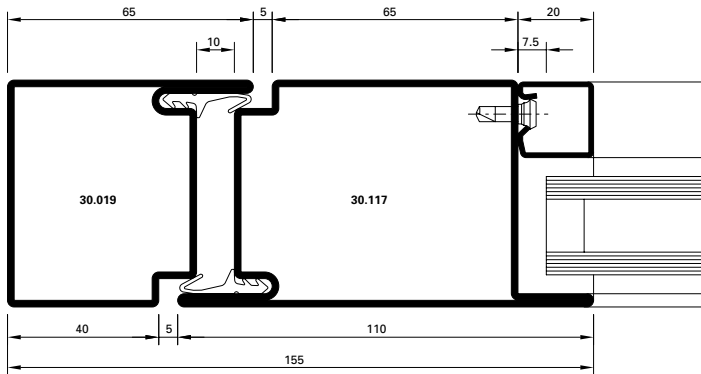

**DXF** **DWG** *D-250-C-006*

3.1

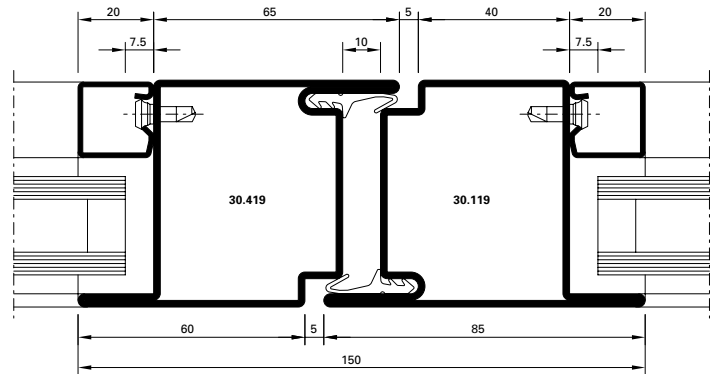

**DXF** **DWG** *D-250-C-007*

3.2

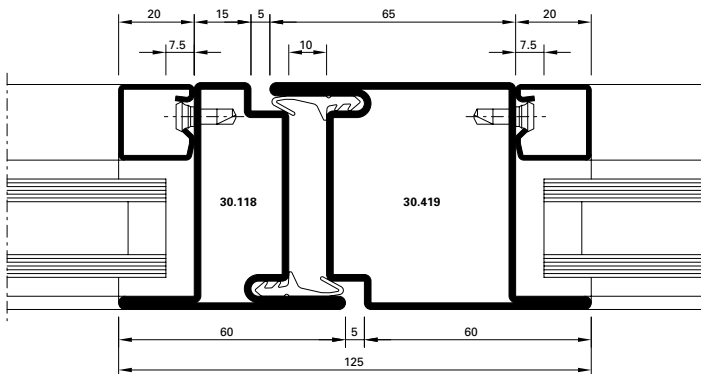

**DXF** **DWG** *D-250-C-008*

3.3

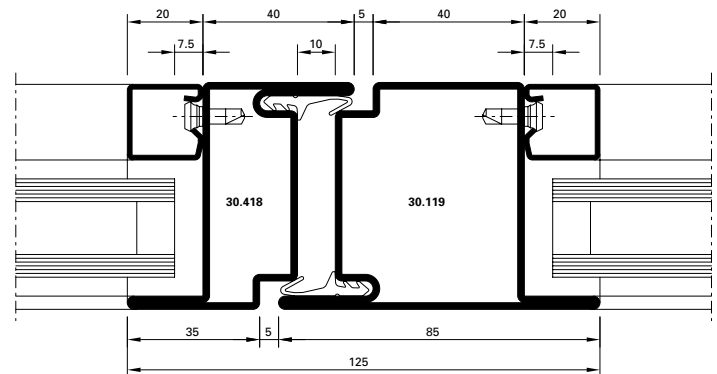

**DXF** **DWG** *D-250-C-009*



9.1

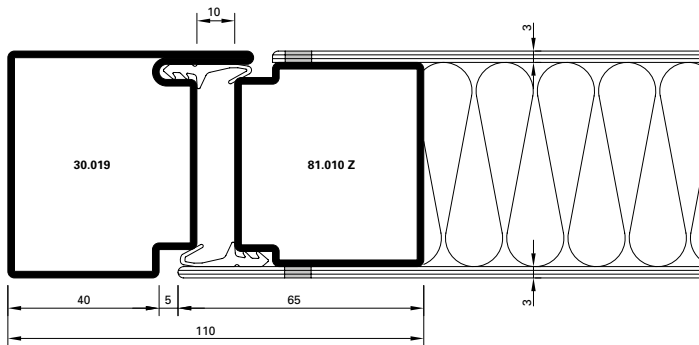

**DXF** **DWG** D-250-C-014

10.0

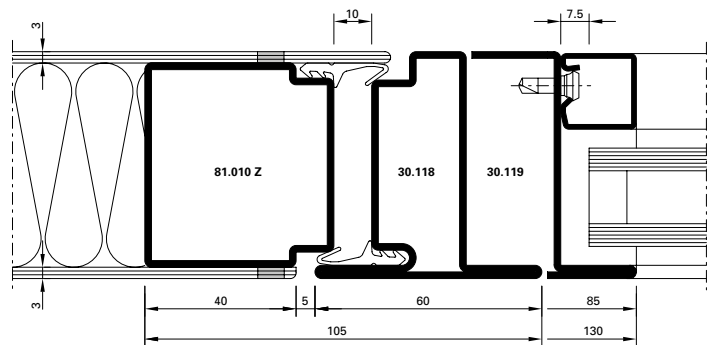

**DXF** **DWG** D-250-C-015

6.0

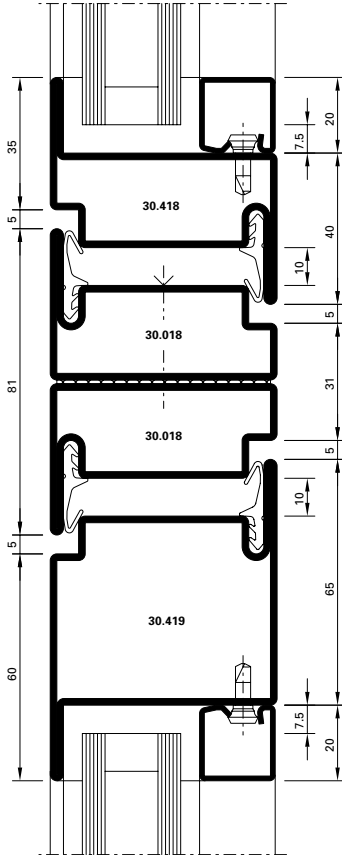

DWG

DXF

D-250-C-016

7.0

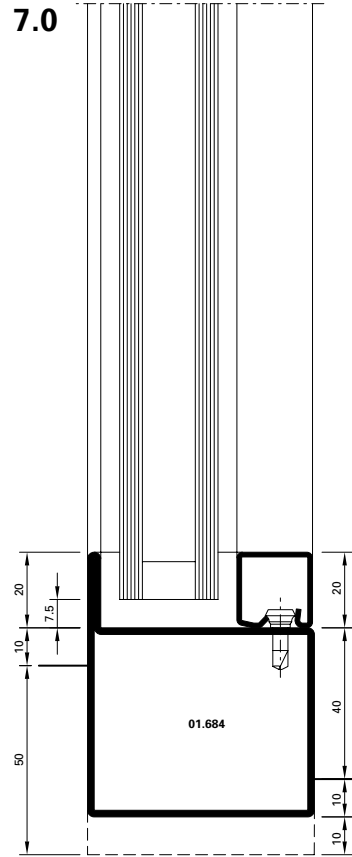

DWG

DXF

D-250-C-017

8.2

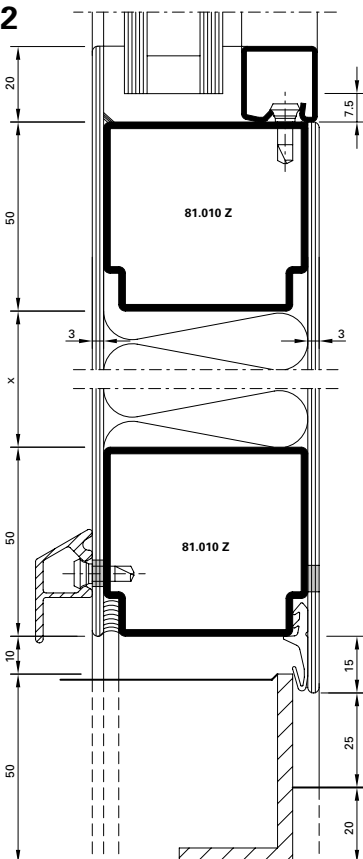

DWG

DXF

D-250-C-021

5.1

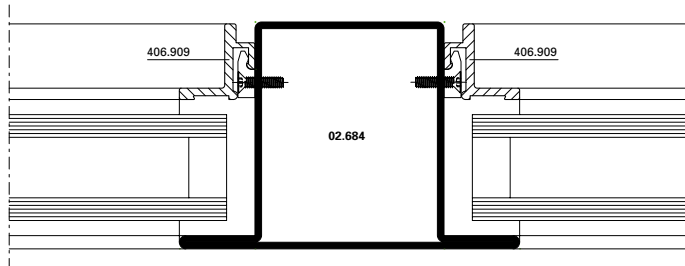

**DXF** **DWG** *D-250-C-022*

5.2

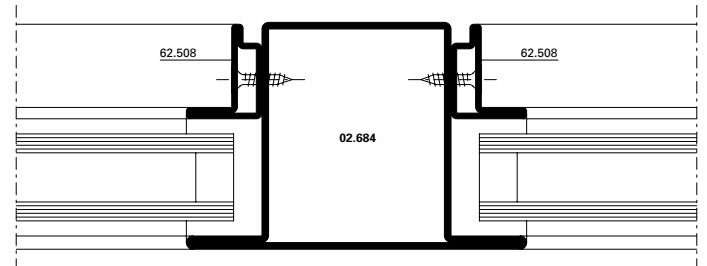

**DXF** **DWG** *D-250-C-023*

5.3

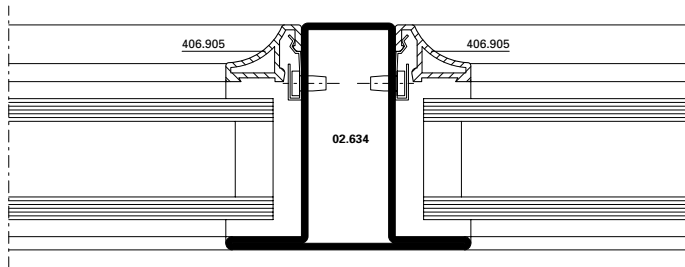

**DXF** **DWG** *D-250-C-024*

5.4

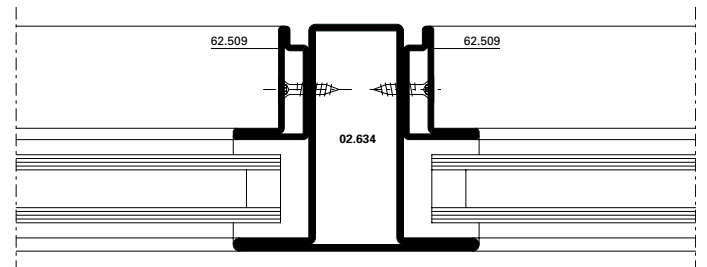

**DXF** **DWG** *D-250-C-025*

5.5

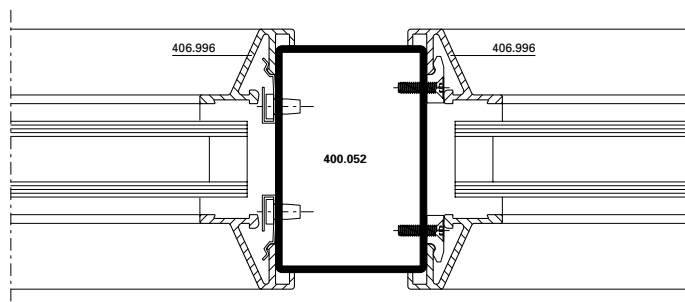

**DXF** **DWG** *D-250-C-026*

5.6

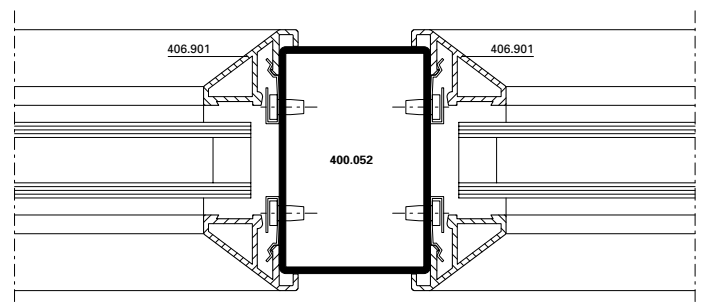

**DXF** **DWG** *D-250-C-027*

5.7

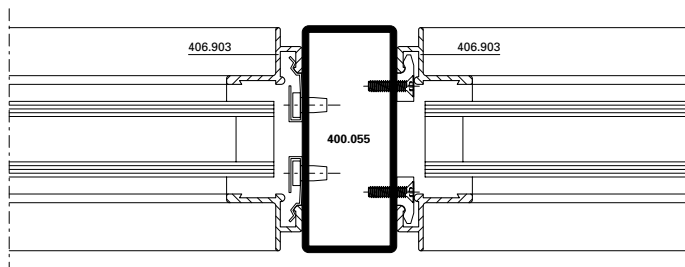

**DXF** **DWG** *D-250-C-028*

5.8

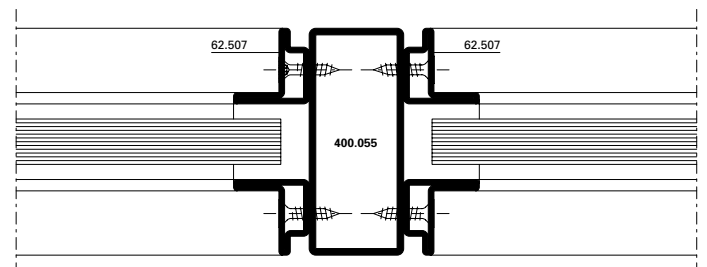

**DXF** **DWG** *D-250-C-029*

**Schnittpunkte im Massstab 1:1**  
**Coupe de détails à l'échelle 1:1**  
**Section details on scale 1:1**

**Jansen-Economy 60 Türen**  
**Jansen-Economy 60 portes**  
**Jansen-Economy 60 doors**

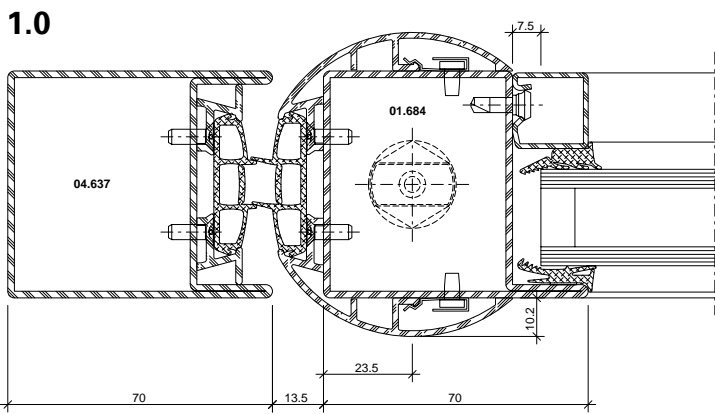
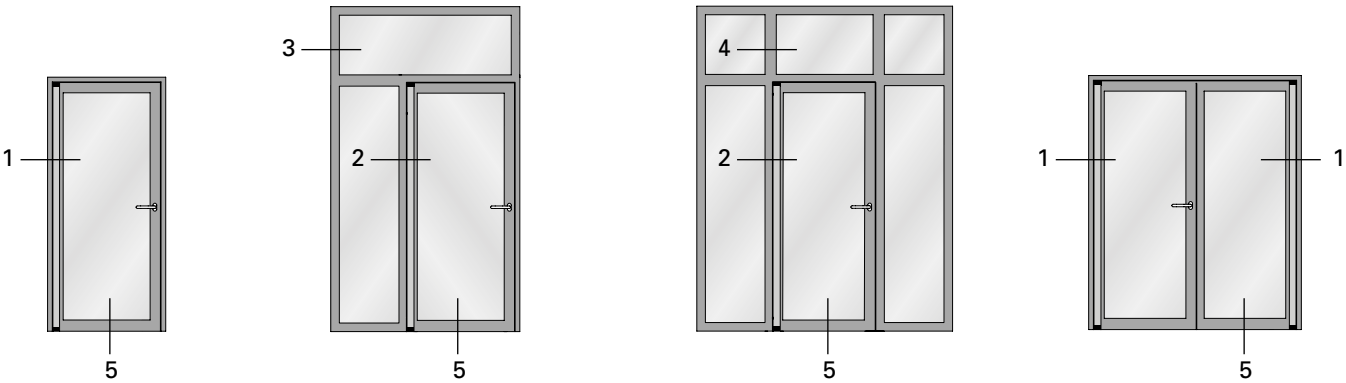

**DXF** **DWG** 22-0103-C-001

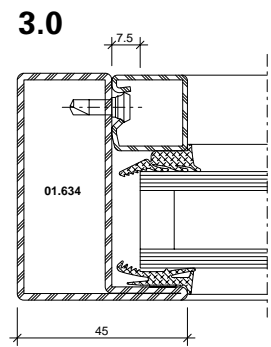

22-0101-C-001  
**DXF** **DWG**

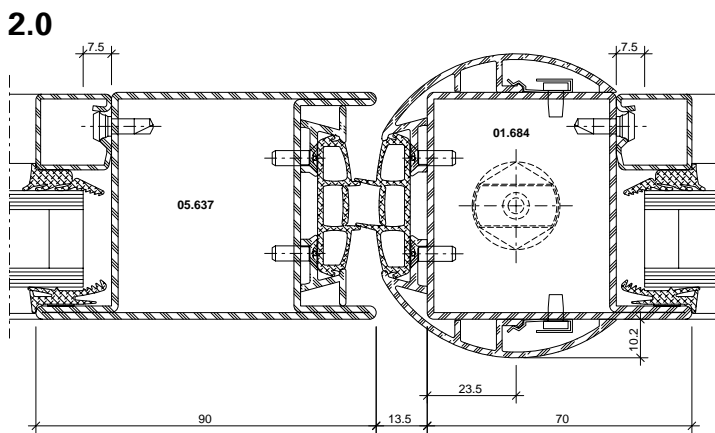

**DXF** **DWG** 22-0103-C-002

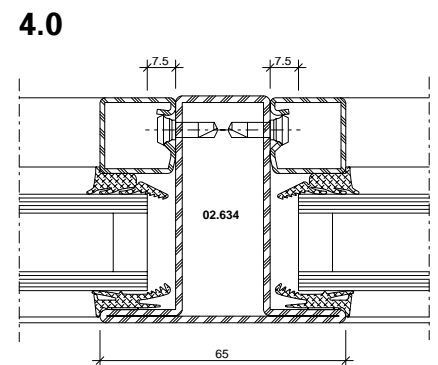

22-0101-C-002  
**DXF** **DWG**

5.0

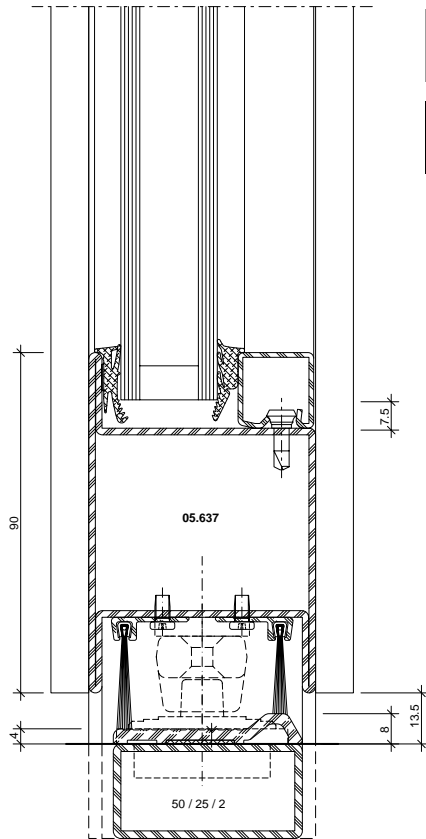

DWG

DXF

22-0103-C-003

5.1

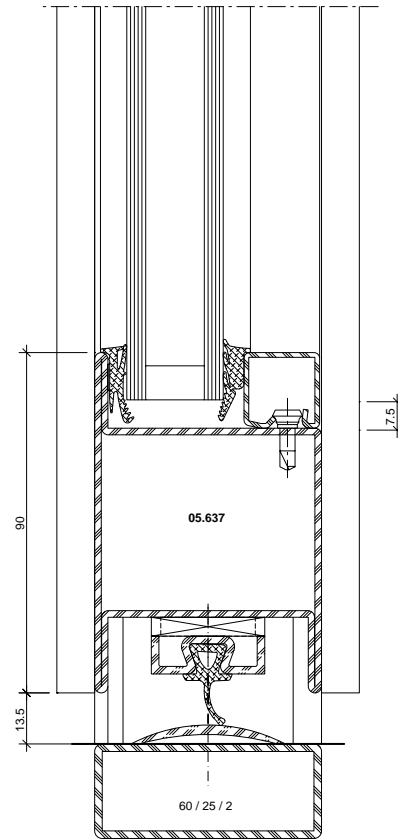

DWG

DXF

22-0103-C-009

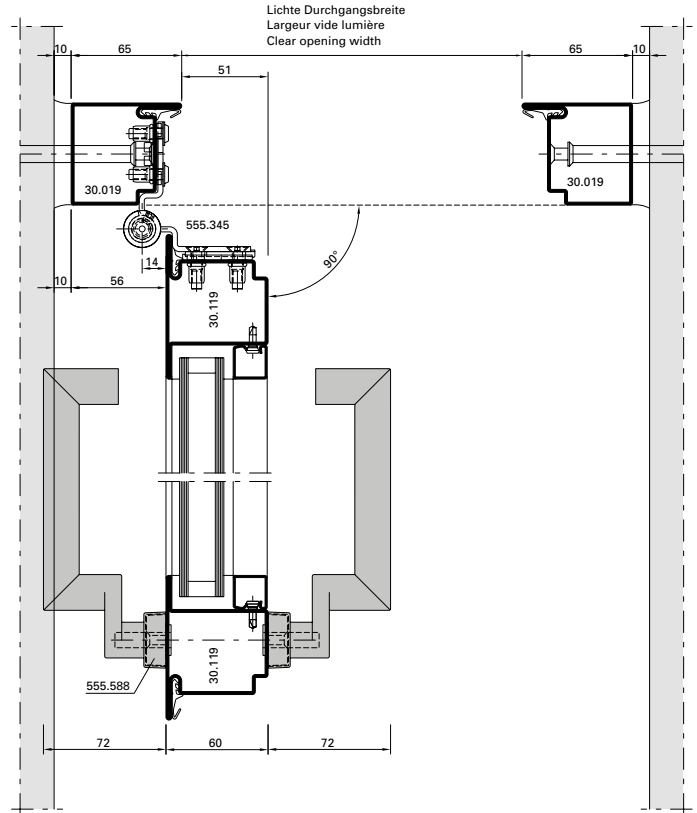
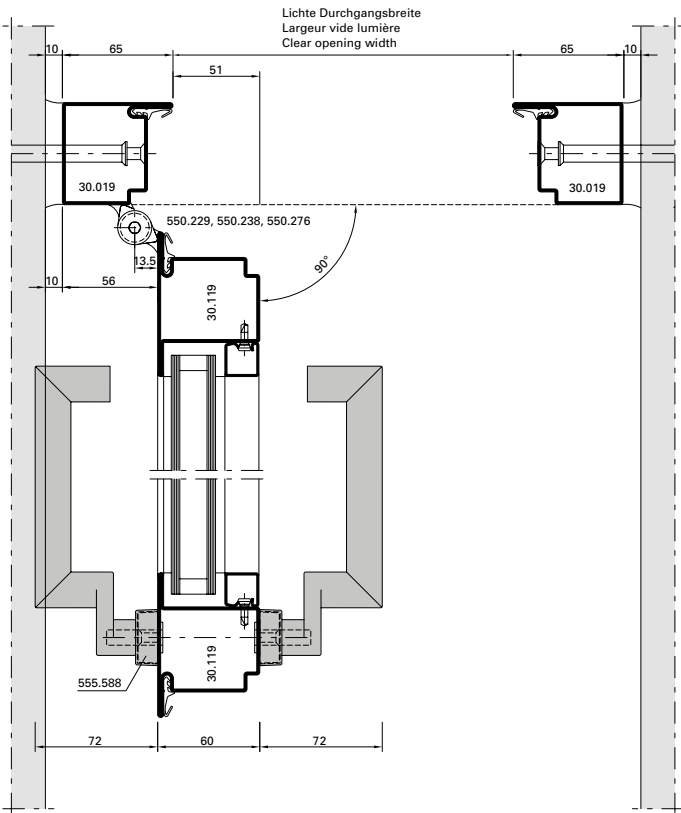

**DXF** **DWG** *D-250-E-016*

**DXF** **DWG** *D-250-E-018*

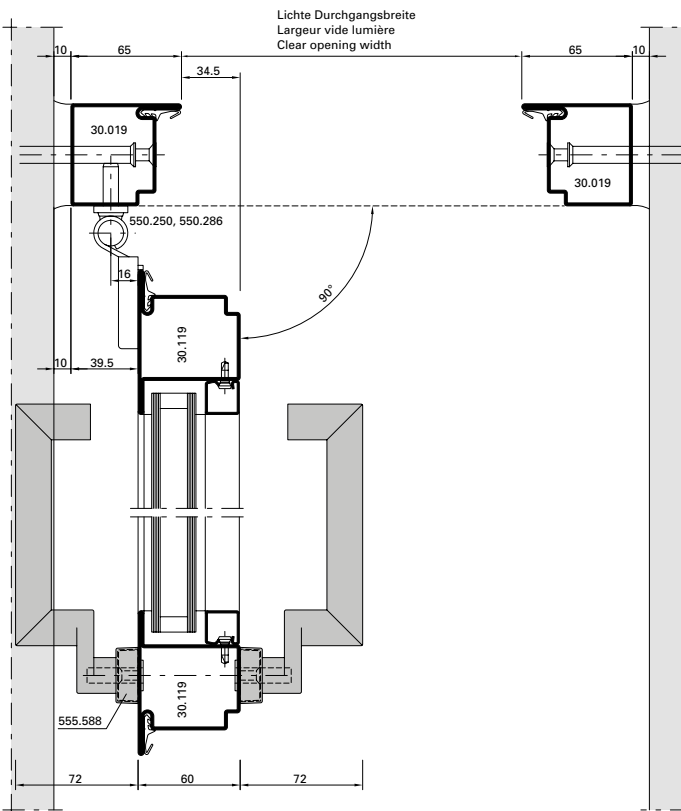

**DXF** **DWG** *D-250-E-020*

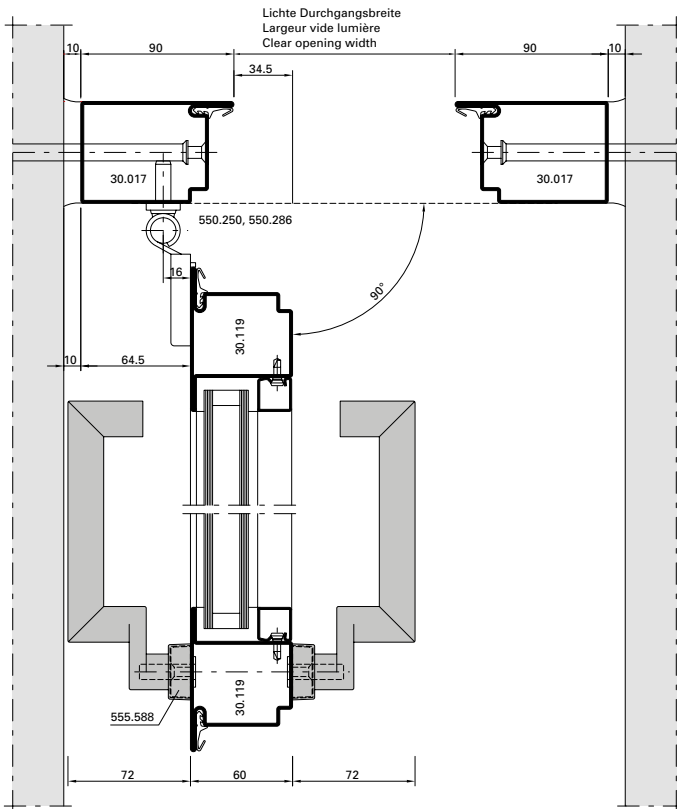

DXF DWG D-250-E-021

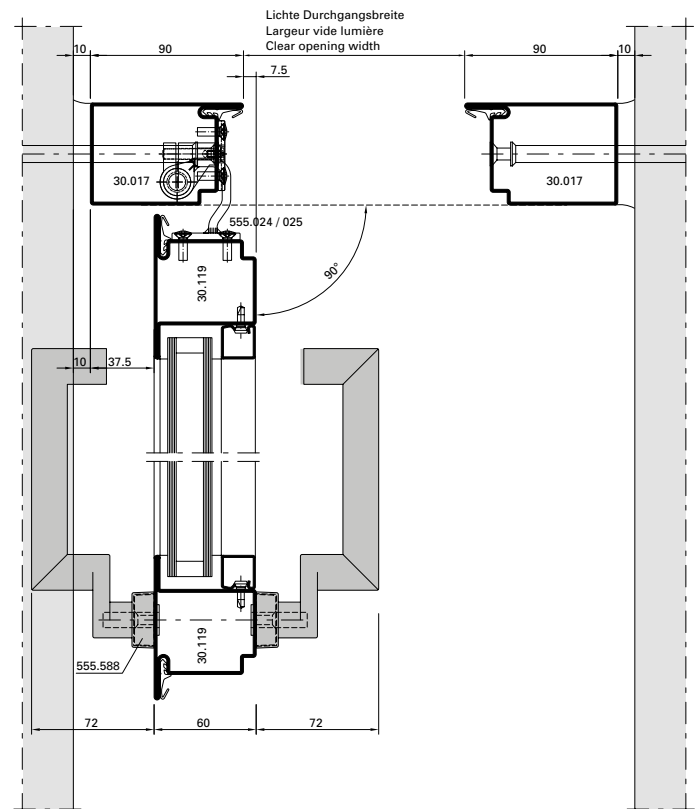

DXF DWG D-250-E-025

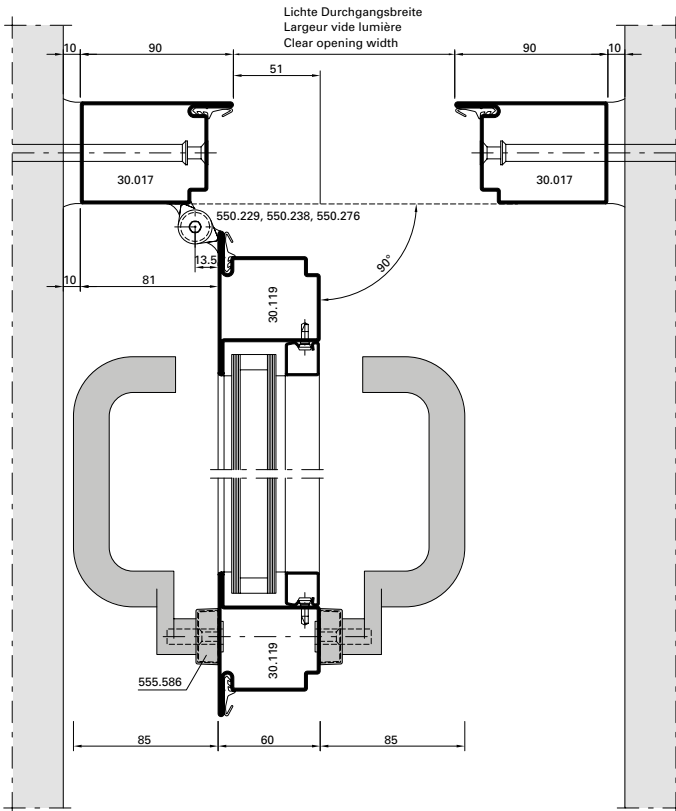

**DXF** **DWG** *D-250-E-017*

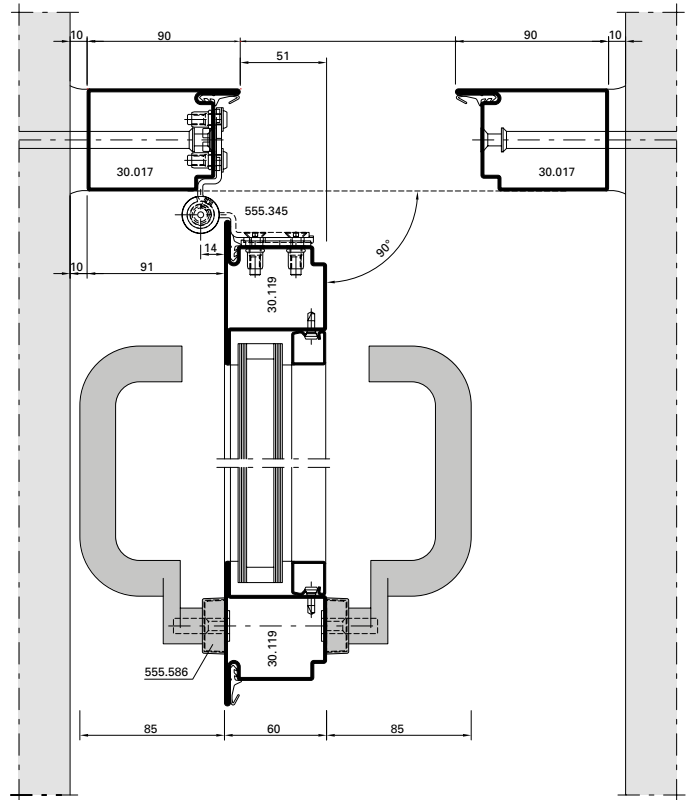

**DXF** **DWG** *D-250-E-019*

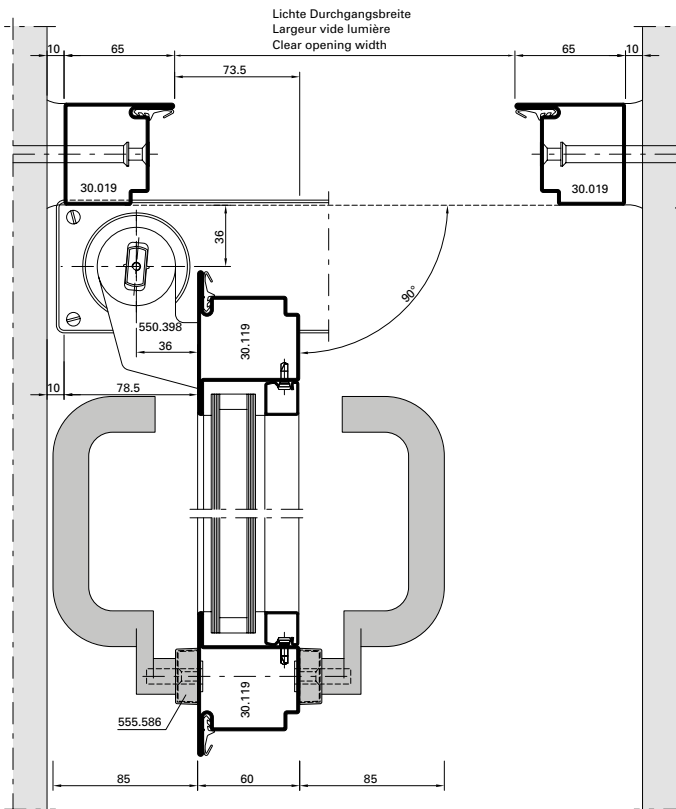

**DXF** **DWG** *D-250-E-022*



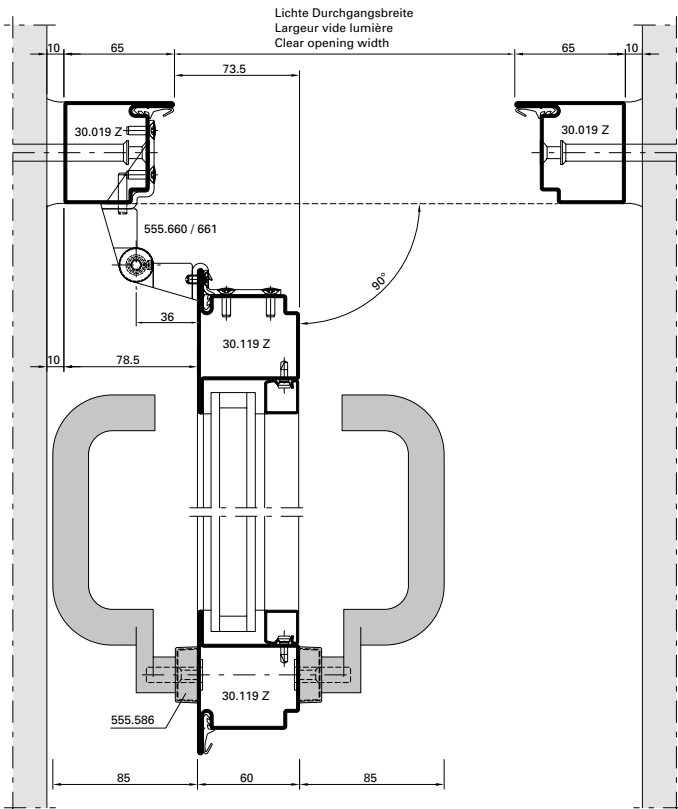

**DXF** **DWG** *D-250-E-023*

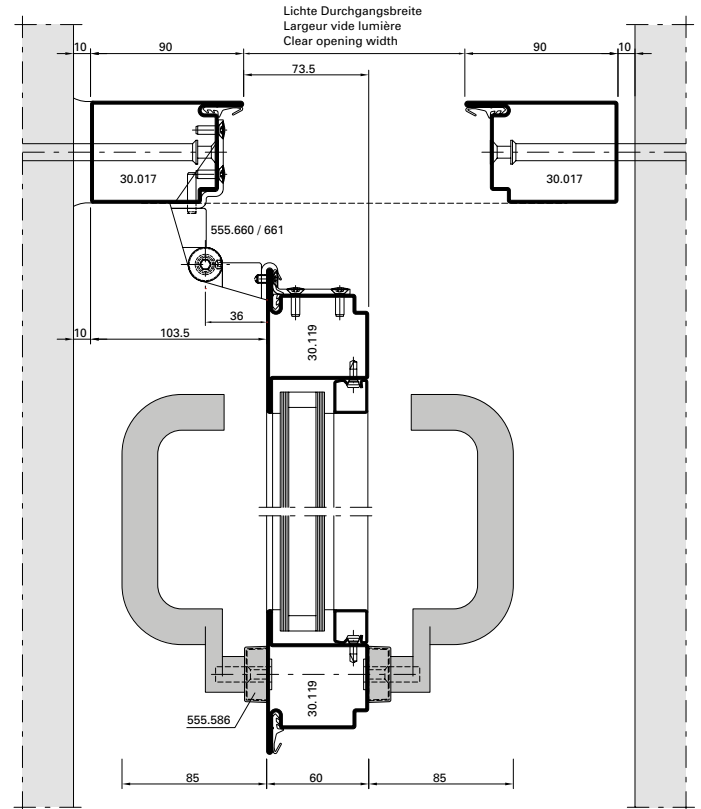

**DXF** **DWG** *D-250-E-024*

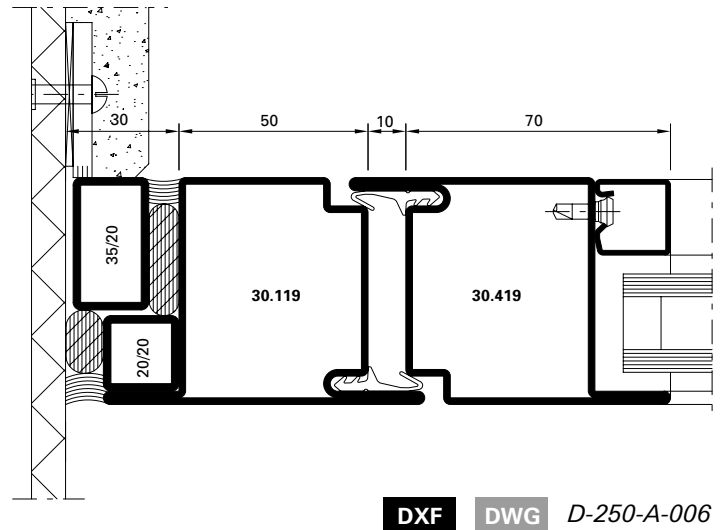
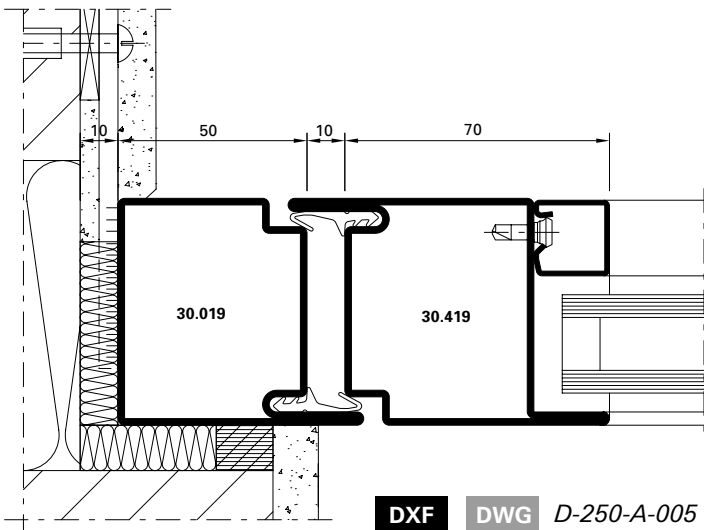
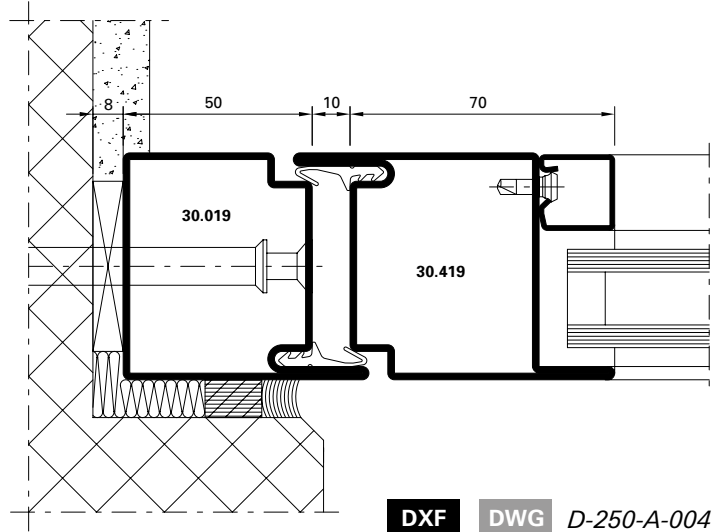
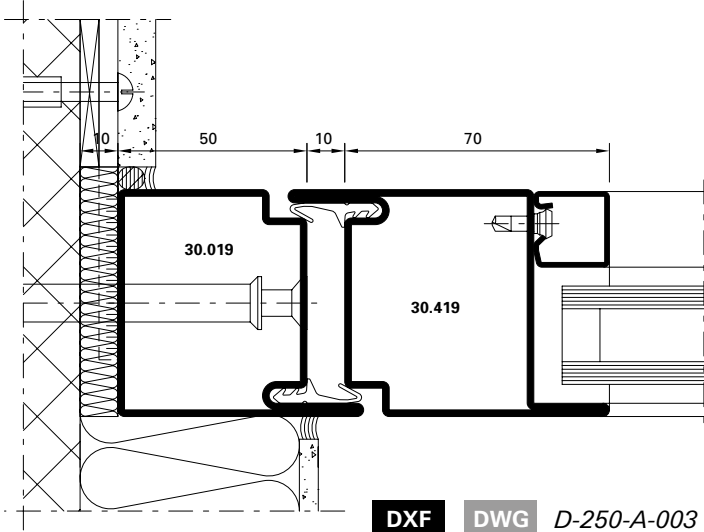
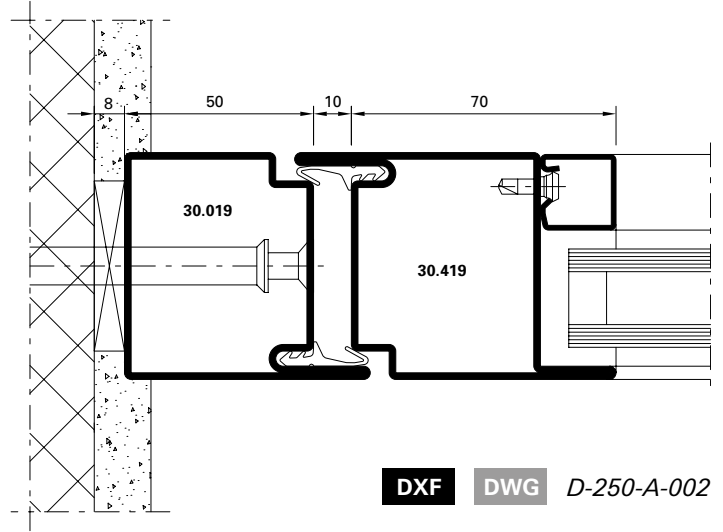
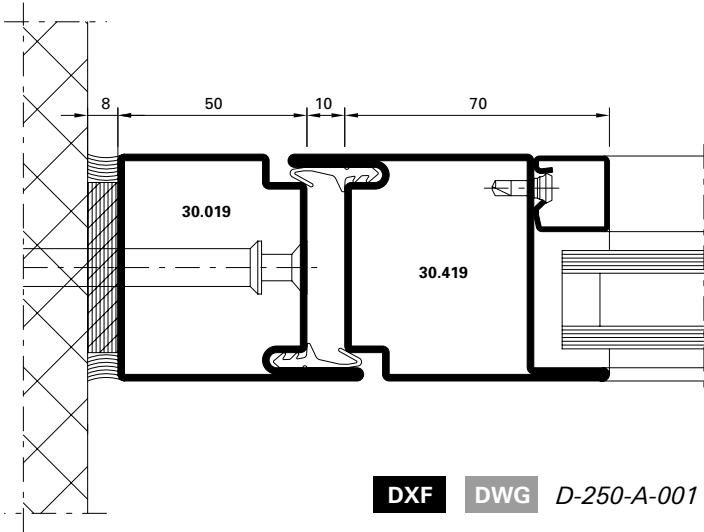

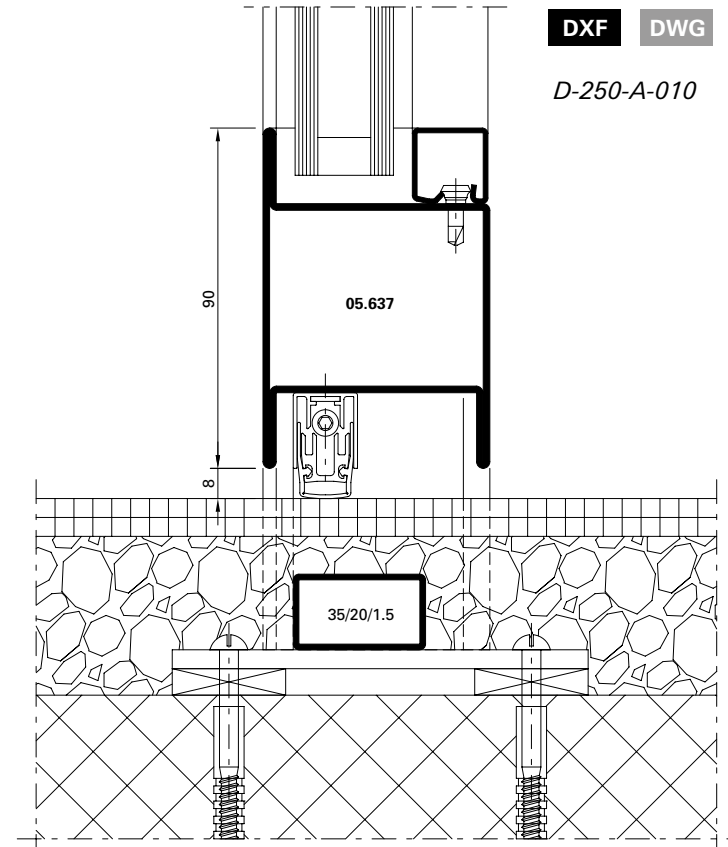
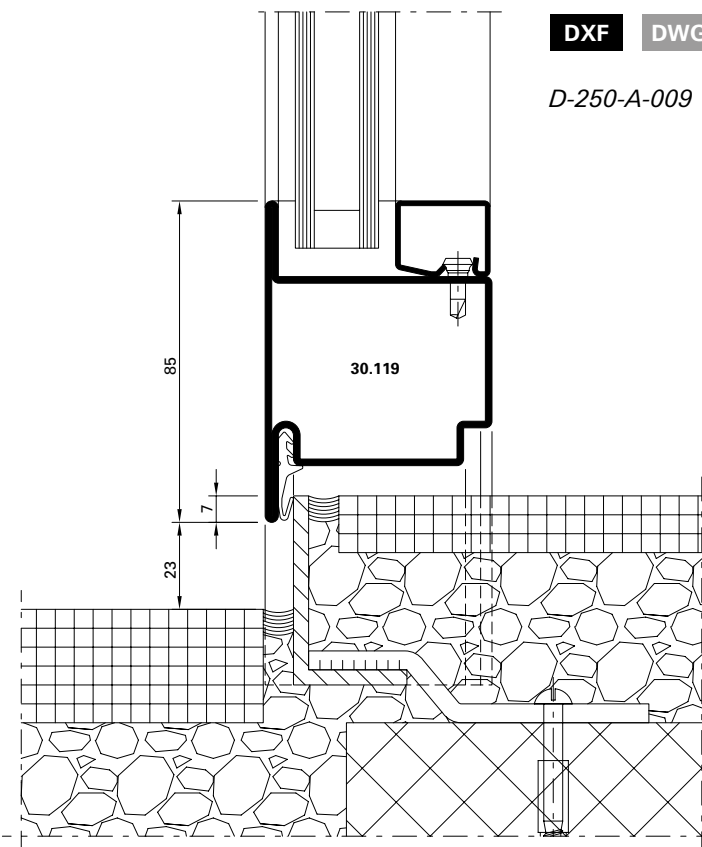
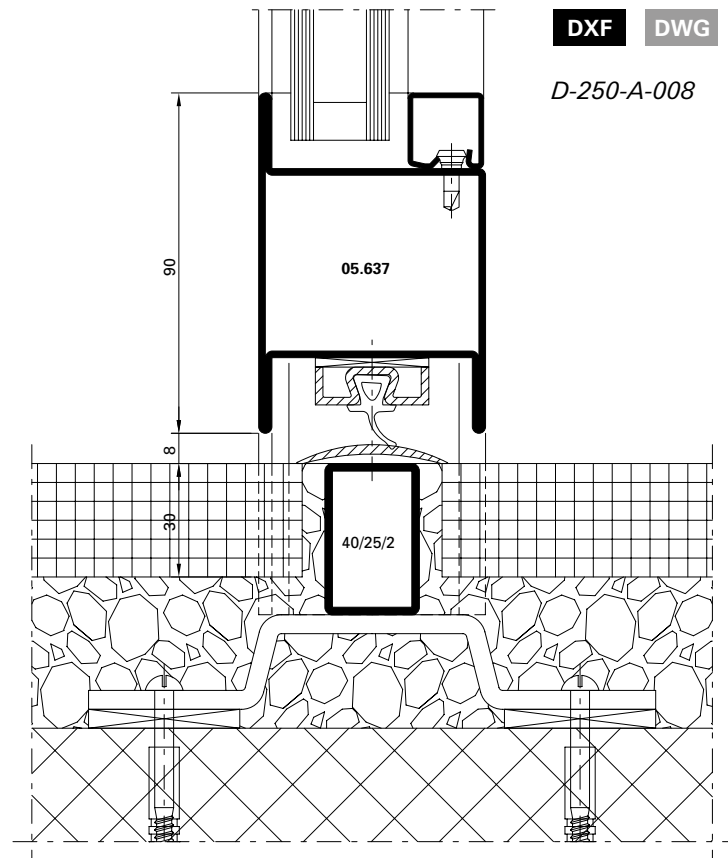
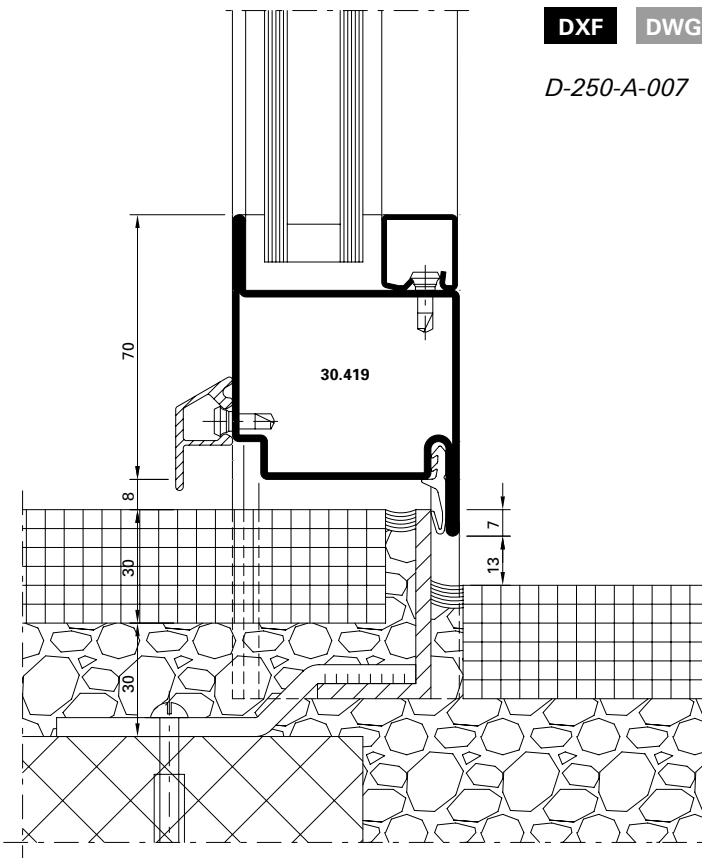



Einflügelige Türen,  
 auswärts öffnend,  
 Flügelhöhe ≤ 2200 mm

Porte à un vantail,  
 ouvrant vers l'extérieur,  
 hauteur du vantail ≤ 2200 mm

Single leaf door,  
 outward opening,  
 leaf height ≤ 2200 mm

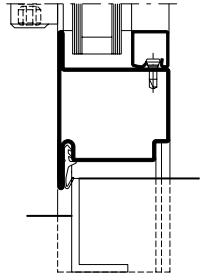
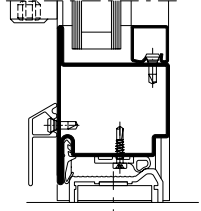
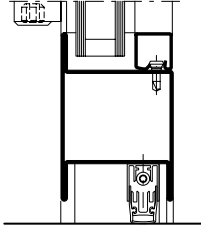
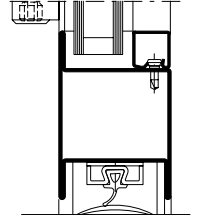
Variante	Beschlag Ferrure Fitting	 EN 12207	 EN 12208	 EN 12210
Anschlagdichtung Joint de butée Rebate gasket 	1	2	1A	C4
	2	2	2A	C4
	3	3	2A	C5
Doppel-Anschlagdichtung Joint de base double Double rebate gasket 	1	4	3A	C4
	2	4	3A	C4
	3	4	5A	C5
Senkdichtung Joint seuil Drop seal 	1	2	1A	C4
	2	2	2A	C4
	3	3	2A	C5
Auflaufdichtung Joint de contact Ramp seal 	1	2	0	C4
	2	2	0	C4
	3	2	0	C5

1 Fallenriegel-Schloss  
 Serrure à mortaiser  
 Latch and bolt lock





2 Schloss mit Obenverriegelung  
 Serrure avec verrouillage supérieur  
 Lock with top locking point

3 Mehrfachverriegelungs-Schloss  
 Serrure à verrouillage multiple  
 Multipoint lock

Einflügelige Türen,  
 einwärts öffnend,  
 Flügelhöhe ≤ 2200 mm

Porte à un vantail,  
 ouvrant vers l'intérieur,  
 hauteur du vantail ≤ 2200 mm

Single leaf door,  
 inward opening,  
 leaf height ≤ 2200 mm

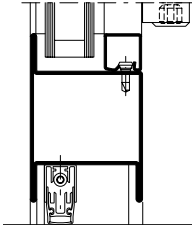
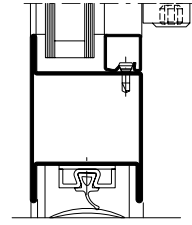
Variante		Beschlag Ferrure Fitting	 EN 12207	 EN 12208	 EN 12210
Senkdichtung Joint seuil Drop seal		❶	2	0	C4
		❷	2	0	C4
		❸	3	1A	C5
Auflaufdichtung Joint de contact Ramp seal		❶	2	0	C4
		❷	2	0	C4
		❸	2	0	C5

❶ Fallenriegel-Schloss  
 Serrure à mortaiser  
 Latch and bolt lock



❷ Schloss mit Obenverriegelung  
 Serrure avec verrouillage supérieur  
 Lock with top locking point

❸ Mehrfachverriegelungs-Schloss  
 Serrure à verrouillage multiple  
 Multipoint lock

Einflügelige Türen,  
 auswärts öffnend,  
 Flügelhöhe ≤ 3000 mm

Porte à un vantail,  
 ouvrant vers l'extérieur,  
 hauteur du vantail ≤ 3000 mm

Single leaf door,  
 outward opening,  
 leaf height ≤ 3000 mm

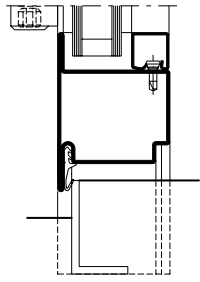
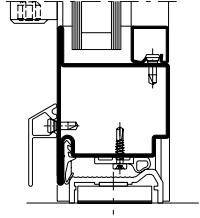
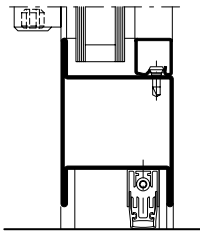
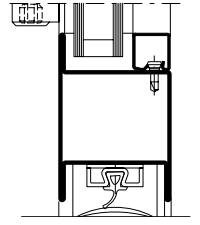
Variante	Beschlag Ferrure Fitting	 EN 12207	 EN 12208	 EN 12210	
Anschlagdichtung Joint de butée Rebate gasket		1	1	0	C1
		2	1	0	C1
		3	1	0	C2
Doppel-Anschlagdichtung Joint de base double Double rebate gasket		1	1	1A	C1
		2	1	1A	C1
		3	2	2A	C2
Senkdichtung Joint seuil Drop seal		1	1	0	C1
		2	1	0	C1
		3	1	0	C2
Auflaufdichtung Joint de contact Ramp seal		1	0	0	C1
		2	0	0	C1
		3	1	0	C2

1 Fallenriegel-Schloss  
 Serrure à mortaiser  
 Latch and bolt lock





2 Schloss mit Obenverriegelung  
 Serrure avec verrouillage supérieur  
 Lock with top locking point

3 Mehrfachverriegelungs-Schloss  
 Serrure à verrouillage multiple  
 Multipoint lock

Einflügelige Türen,  
 einwärts öffnend,  
 Flügelhöhe ≤ 3000 mm

Porte à un vantail,  
 ouvrant vers l'intérieur,  
 hauteur du vantail ≤ 3000 mm

Single leaf door,  
 inward opening,  
 leaf height ≤ 3000 mm

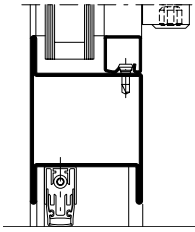
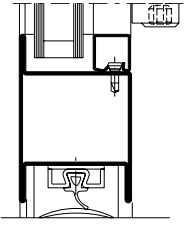
Variante		Beschlag Ferrure Fitting	 EN 12207	 EN 12208	 EN 12210
Senkdichtung Joint seuil Drop seal		❶	1	0	C1
		❷	1	0	C1
		❸	1	0	C2
Auflaufdichtung Joint de contact Ramp seal		❶	0	0	C1
		❷	0	0	C1
		❸	1	0	C2

❶ Fallenriegel-Schloss  
 Serrure à mortaiser  
 Latch and bolt lock



❷ Schloss mit Obenverriegelung  
 Serrure avec verrouillage supérieur  
 Lock with top locking point

❸ Mehrfachverriegelungs-Schloss  
 Serrure à verrouillage multiple  
 Multipoint lock

Zweiflügelige Türen,  
 auswärts öffnend,  
 Flügelhöhe ≤ 2200 mm

Porte à deux vantaux,  
 ouvrant vers l'extérieur,  
 hauteur du vantail ≤ 2200 mm

Double leaf door,  
 outward opening,  
 leaf height ≤ 2200 mm

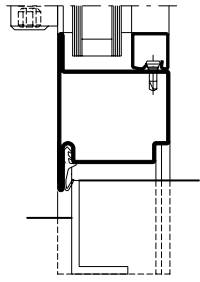
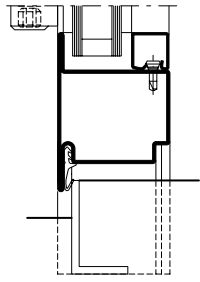
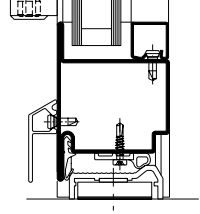
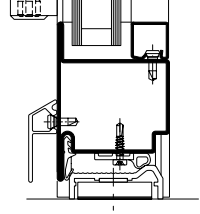
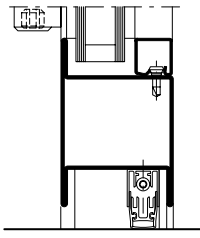
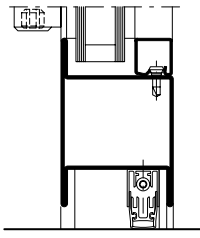
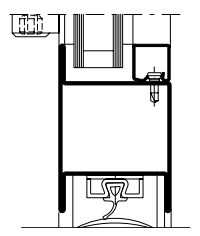
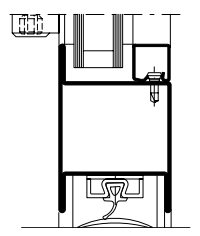
Variante	Beschlag Ferrure Fitting	 EN 12207	 EN 12208	 EN 12210	
Anschlagdichtung Joint de butée Rebate gasket 	Beschlag Ferrure Fitting 	1	2	1A	C2
		2	2	2A	C2
		3	2	2A	C3
Doppel-Anschlagdichtung Joint de base double Double rebate gasket 	Beschlag Ferrure Fitting 	1	2	2A	C2
		2	2	2A	C2
		3	3	3A	C3
Senkdichtung Joint seuil Drop seal 	Beschlag Ferrure Fitting 	1	2	1A	C2
		2	2	2A	C2
		3	2	2A	C3
Auflaufdichtung Joint de contact Ramp seal 	Beschlag Ferrure Fitting 	1	2	0	C2
		2	2	0	C2
		3	2	0	C3

**1** Fallenriegel-Schloss  
 Serrure à mortaiser  
 Latch and bolt lock

**2** Schloss mit Obenverriegelung  
 Serrure avec verrouillage supérieur  
 Lock with top locking point





**3** Mehrfachverriegelungs-Schloss  
 Serrure à verrouillage multiple  
 Multipoint lock

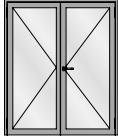

Zweiflügelige Türen,  
 einwärts öffnend,  
 Flügelhöhe ≤ 2200 mm

Porte à deux vantaux,  
 ouvrant vers l'intérieur,  
 hauteur du vantail ≤ 2200 mm

Double leaf door,  
 inward opening,  
 leaf height ≤ 2200 mm

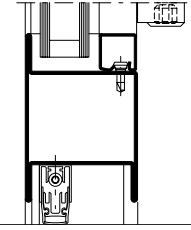
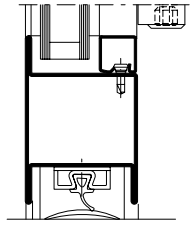
Variante		Beschlag Ferrure Fitting	 EN 12207	 EN 12208	 EN 12210
Senkdichtung Joint seuil Drop seal		❶	2	0	C2
		❷	2	0	C2
		❸	2	0	C3
Auflaufdichtung Joint de contact Ramp seal		❶	2	0	C2
		❷	2	0	C2
		❸	2	0	C3

❶ Fallenriegel-Schloss  
 Serrure à mortaiser  
 Latch and bolt lock



❷ Schloss mit Obenverriegelung  
 Serrure avec verrouillage supérieur  
 Lock with top locking point

❸ Mehrfachverriegelungs-Schloss  
 Serrure à verrouillage multiple  
 Multipoint lock

Zweiflügelige Türen,  
 auswärts öffnend,  
 Flügelhöhe ≤ 3000 mm

Porte à deux vantaux,  
 ouvrant vers l'extérieur,  
 hauteur du vantail ≤ 3000 mm

Double leaf door,  
 outward opening,  
 leaf height ≤ 3000 mm

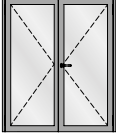
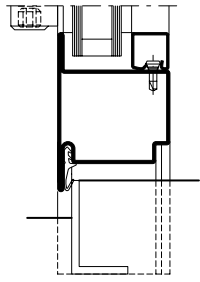
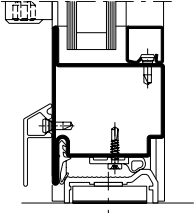
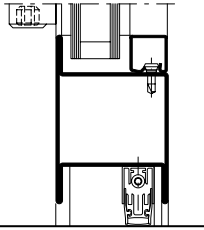
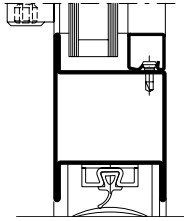
Variante	Beschlag Ferrure Fitting	 EN 12207	 EN 12208	 EN 12210	
					
Anschlagdichtung Joint de butée Rebate gasket		❶	0	0	C1
		❷	0	0	C1
		❸	1	0	C2
Doppel-Anschlagdichtung Joint de base double Double rebate gasket		❶	1	0	C1
		❷	1	0	C1
		❸	2	0	C2
Senkdichtung Joint seuil Drop seal		❶	0	0	C1
		❷	0	0	C1
		❸	1	0	C2
Auflaufdichtung Joint de contact Ramp seal		❶	0	0	C1
		❷	0	0	C1
		❸	1	0	C2

❶ Fallenriegel-Schloss  
 Serrure à mortaiser  
 Latch and bolt lock





❷ Schloss mit Obenverriegelung  
 Serrure avec verrouillage supérieur  
 Lock with top locking point

❸ Mehrfachverriegelungs-Schloss  
 Serrure à verrouillage multiple  
 Multipoint lock

Zweiflügelige Türen,  
 einwärts öffnend,  
 Flügelhöhe ≤ 3000 mm

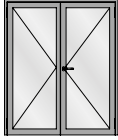
Porte à deux vantaux,  
 ouvrant vers l'intérieur,  
 hauteur du vantail ≤ 3000 mm

Double leaf door,  
 inward opening,  
 leaf height ≤ 3000 mm

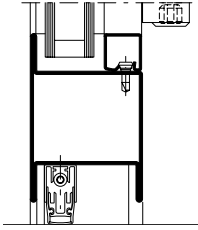
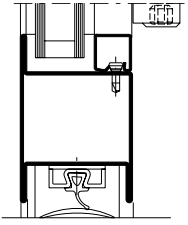
Variante		Beschlag Ferrure Fitting	 EN 12207	 EN 12208	 EN 12210
Senkdichtung Joint seuil Drop seal		1	0	0	C1
		2	0	0	C1
		3	1	0	C2
Auflaufdichtung Joint de contact Ramp seal		1	0	0	C1
		2	0	0	C1
		3	1	0	C2

**U<sub>f</sub>-Werte**  
(nach EN ISO 10077-2:2018-01)

**Valeurs U<sub>f</sub>**  
(selon EN ISO 10077-2:2018-01)

**U<sub>f</sub> values**  
(according to  
EN ISO 10077-2:2018-01)

Auf den folgenden Seiten  
finden Sie die U<sub>f</sub>-Werte für die  
verschiedenen Anwendungen von  
Jansen-Economy 60.

Vous trouverez les valeurs U<sub>f</sub>  
pour les différentes applications  
Jansen-Economy 60 dans les  
pages qui suivent.

On the following pages you  
will find the U<sub>f</sub> values for the  
various applications for  
Jansen-Economy 60.

Sie basieren auf folgenden  
Grundlagen:

Elles se basent sur les principes  
suivants:

They are based on the following:

**Stahl**

- Profile bandverzinkter Stahl,  
unbeschichtet
- Stahl-Glasleisten
- Trockenverglasung
- Nassverglasung

**Acier**

- Profilés en bande d'acier zingué,  
sans revêtement
- Parcloses en acier
- Vitrage à sec
- Vitrage à mastic



**Steel**

- Strip galvanised steel profiles,  
uncoated
- Steel glazing beads
- Glazing with dry glazing
- Glazing with sealing

**U<sub>f</sub>-Werte**  
 (nach EN ISO 10077-2:2018-01)

**Valeurs U<sub>f</sub>**  
 (selon EN ISO 10077-2:2018-01)

**U<sub>f</sub> values**  
 (according to EN ISO 10077-2:2018-01)

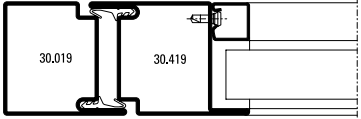
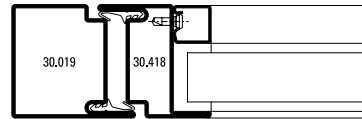
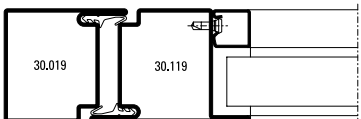
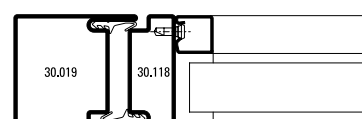
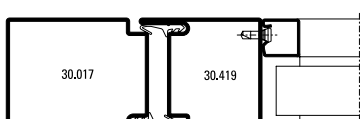
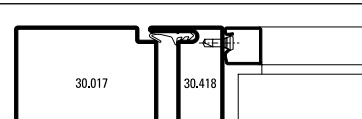
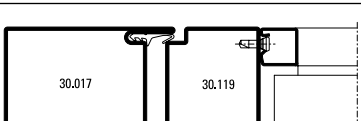
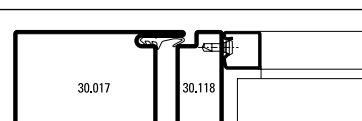
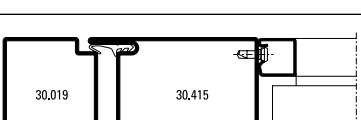
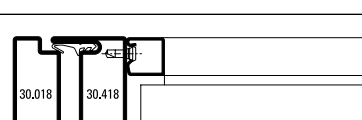
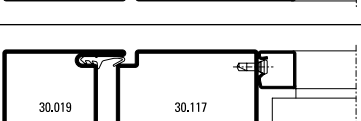
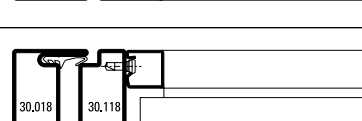
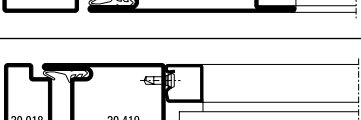
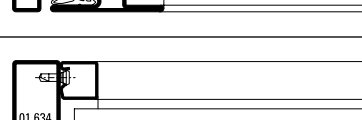
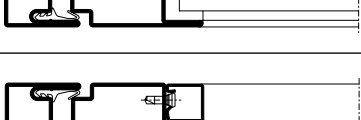
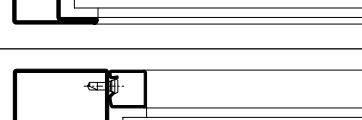
 Füllelementstärken Elements de remplissages Infill elements ≥ 24 mm		 Füllelementstärken Elements de remplissages Infill elements ≥ 24 mm	
	5,5 W/m <sup>2</sup> K		5,7 W/m <sup>2</sup> K
	5,6 W/m <sup>2</sup> K		5,8 W/m <sup>2</sup> K
	5,3 W/m <sup>2</sup> K		5,5 W/m <sup>2</sup> K
	5,3 W/m <sup>2</sup> K		5,5 W/m <sup>2</sup> K
	5,3 W/m <sup>2</sup> K		6,0 W/m <sup>2</sup> K
	5,3 W/m <sup>2</sup> K		6,1 W/m <sup>2</sup> K
	5,6 W/m <sup>2</sup> K		6,9 W/m <sup>2</sup> K
	5,7 W/m <sup>2</sup> K		6,1 W/m <sup>2</sup> K

**U<sub>f</sub>-Werte**  
 (nach EN ISO 10077-2:2018-01)

**Valeurs U<sub>f</sub>**  
 (selon EN ISO 10077-2:2018-01)

**U<sub>f</sub> values**  
 (according to EN ISO 10077-2:2018-01)

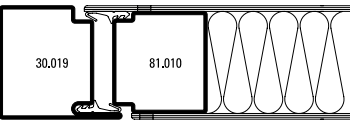
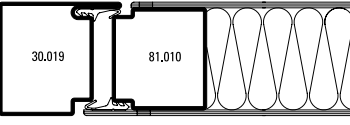
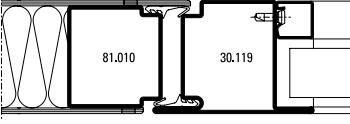
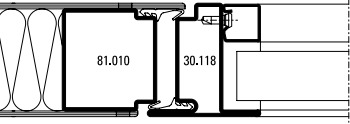
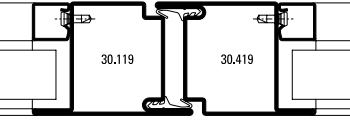
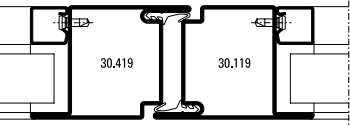
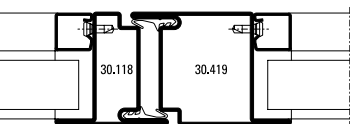
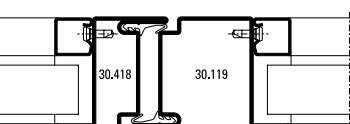
 Füllelementstärken Elements de remplissages Infill elements	≥ 24 mm
	5,3 W/m²K
	5,3 W/m²K
	5,7 W/m²K
	6,0 W/m²K
	5,8 W/m²K
	5,8 W/m²K
	6,1 W/m²K
	6,1 W/m²K

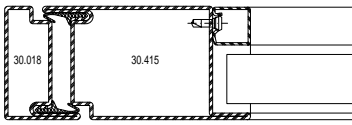
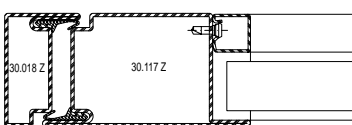
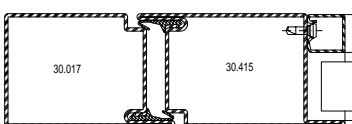
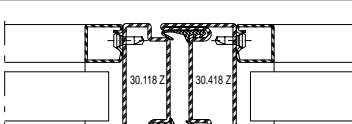
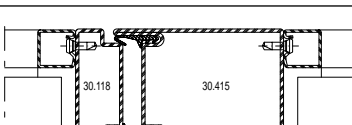
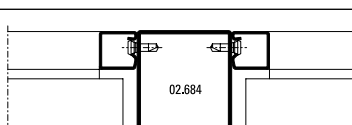
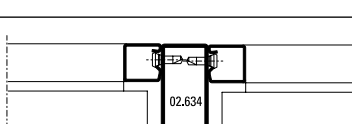
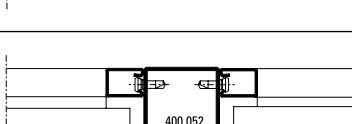
 Füllelementstärken Elements de remplissages Infill elements	≥ 24 mm
	5,3 W/m²K
	5,4 W/m²K
	5,1 W/m²K
	6,5 W/m²K
	5,7 W/m²K
	6,3 W/m²K
	7,2 W/m²K
	6,4 W/m²K

**U<sub>f</sub>-Werte**  
 (nach EN ISO 10077-2:2018-01)

**Valeurs U<sub>f</sub>**  
 (selon EN ISO 10077-2:2018-01)

**U<sub>f</sub> values**  
 (according to EN ISO 10077-2:2018-01)

	Füllelementstärken Elements de remplissages Infill elements  ≥ 24 mm
	5,5 W/m <sup>2</sup> K
	5,7 W/m <sup>2</sup> K
	5,5 W/m <sup>2</sup> K
	5,3 W/m <sup>2</sup> K
	5,3 W/m <sup>2</sup> K

	Füllelementstärken Elements de remplissages Infill elements  ≥ 24 mm
	5,8 W/m <sup>2</sup> K
	6,0 W/m <sup>2</sup> K
	5,4 W/m <sup>2</sup> K
	5,1 W/m <sup>2</sup> K

**U<sub>f</sub>-Werte**  
 (nach EN ISO 10077-2:2018-01)

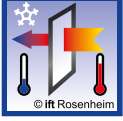
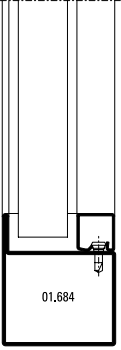
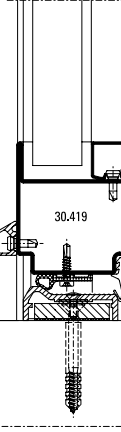
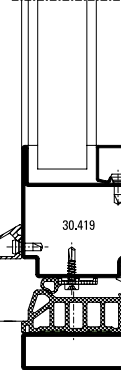
 Füllelementstärken Elements de remplissages Infill elements ≥ 24 mm	
 01.684	6,1 W/m <sup>2</sup> K
 30.419	6,3 W/m <sup>2</sup> K
 30.419	5,6 W/m <sup>2</sup> K

**Valeurs U<sub>f</sub>**  
 (selon EN ISO 10077-2:2018-01)

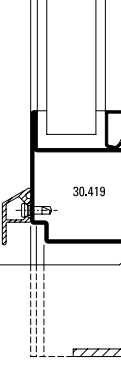
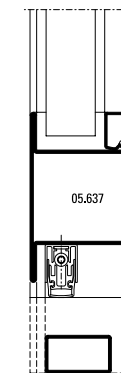
 Füllelementstärken Elements de remplissages Infill elements ≥ 24 mm	
 30.419	6,3 W/m <sup>2</sup> K
 05.637	5,6 W/m <sup>2</sup> K

**U<sub>f</sub> values**  
 (according to EN ISO 10077-2:2018-01)

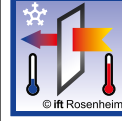
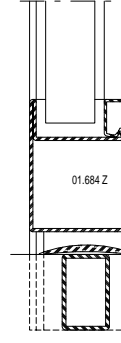
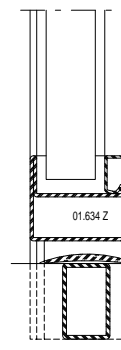
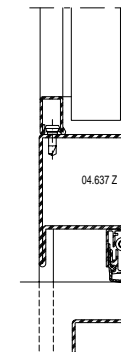
 Füllelementstärken Elements de remplissages Infill elements ≥ 24 mm	
 01.684 Z	6,1 W/m <sup>2</sup> K
 01.634 Z	6,8 W/m <sup>2</sup> K
 04.637 Z	5,5 W/m <sup>2</sup> K



**U<sub>f</sub>-Werte**  
 (nach EN ISO 10077-2:2018-01)

**Valeurs U<sub>f</sub>**  
 (selon EN ISO 10077-2:2018-01)

**U<sub>f</sub> values**  
 (according to EN ISO 10077-2:2018-01)

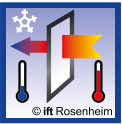
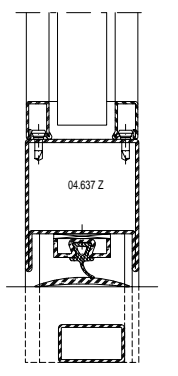
	Füllelementstärken Elements de remplissages Infill elements ≥ 24 mm
	5,6 W/m²K

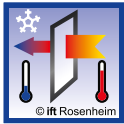
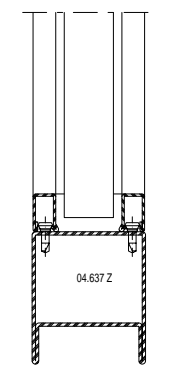
	Füllelementstärken Elements de remplissages Infill elements ≥ 24 mm
	5,6 W/m²K

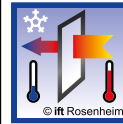
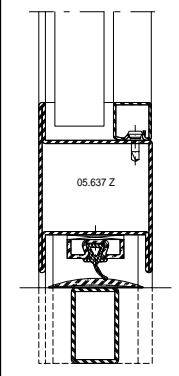
	Füllelementstärken Elements de remplissages Infill elements ≥ 24 mm
	5,7 W/m²K

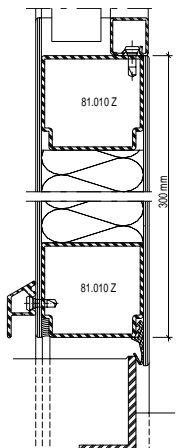
	4,4 W/m²K
--	-----------

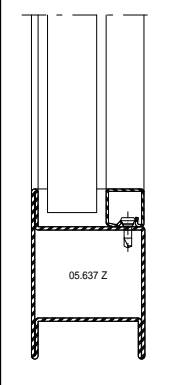
	5,7 W/m²K
--	-----------

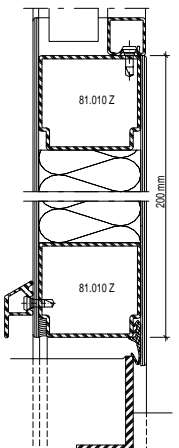
	5,2 W/m²K
---	-----------



## Schallschutz

### Ausführungsvarianten

Die nachfolgende Typenübersicht ergibt einen Überblick über die beurteilten Varianten.

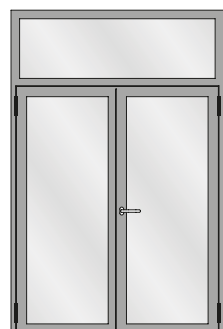
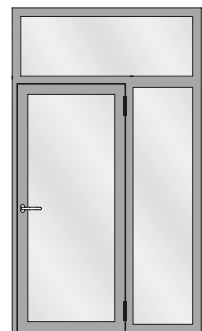
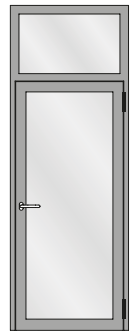
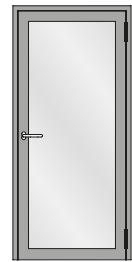

## Isolation phonique

### Modèles

L'aperçu des types suivant fournit une vue d'ensemble des variantes examinées.

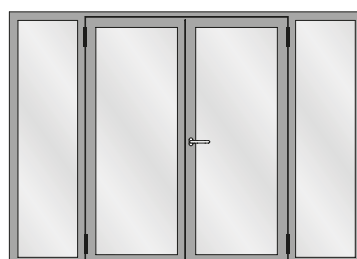
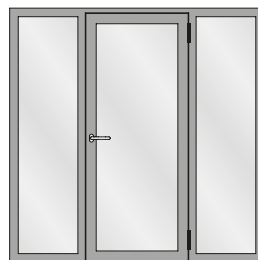
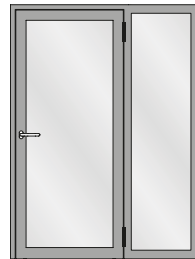
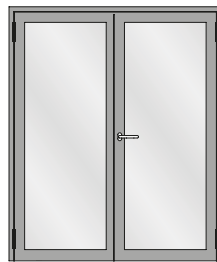

## Sound insulation

### Design range

The following overview of types provides an overview of the evaluated designs.

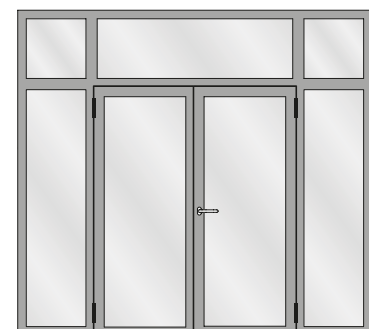
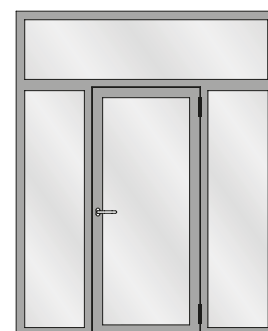

Schallschutz

Isolation phonique

Sound insulation

Tabelle A1

Korrekturtabelle für Jansen-Economy-Türen mit Glasfüllungen

Tableau A1

Tableau de correction pour les portes Jansen-Economy avec vitrage

Table A1

Correction table for Jansen-Economy doors with glass

	1	2	3	4	5	6	7	8	9	10	11
	<b>Türe</b> mit zwei absenkba- ren Bodendichtungen <b>Porte</b> avec deux joint seuil automatique <b>Door</b> with two threshold gaskets that can be lowered	<b>Glas</b>  <b>Verre</b>  <b>Glass</b>	<b>Korrekturen</b>  <b>Corrections</b>  <b>Corrections</b>								
	$R_{w(C, Ctr)}$ dB	$R_{w, P, Glas}$ dB	$K_S$ dB	$K_{FV}$ dB	$K_{Nass}$ dB	$K_{1aB}$ dB	$K_{W/S}$ dB	$K_{G 0,4}$ dB	$K_{G 1,8}$ dB	$K_{G 2,6}$ dB	$K_{G 3,2}$ dB
1	32 (-1; -5)	31	0	-1	0	0	0	0	-1	-2	-3
2	33 (-1; -5)	32	0	-1	0	0	0	0	-1	-2	-3
3	35 (-1; -5)	34	0	-1	0	0	0	0	-1	-2	-3
4	36 (-2; -5)	35	0	-1	-1	0	0	0	-1	-2	-3
5	37 (-2; -5)	37	0	0	-1	0	-1	0	-1	-2	-3
6	38 (-2; -5)	39	0	0	-1	-1	-1	0	-1	-2	-3
7	39 (-2; -5)	40	0	0	-1	-1	-1	0	-1	-2	-3
8	40 (-2; -5)	41	0	0	-1	-1	-2	-1	-1	-2	-3
9	41 (-2; -5)	42	0	0	-1	-1	-2	-2	-1	-2	-3
10	42 (-2; -5)	43	-1	0	-1	-1	-2	-2	-1	-2	-3
11	42 (-2; -5)	44	-1	0	-1	-1	-2	-2	-1	-2	-3
12	43 (-2; -5)	45	-1	+1	-1	-1	-3	-3	-1	-2	-3
13	44 (-2; -5)	49	-1	+1	-1	-2	-3	-3	-1	-2	-3

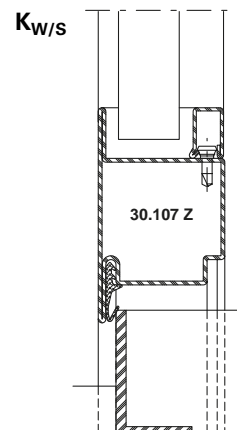
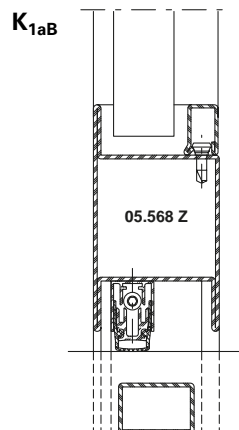
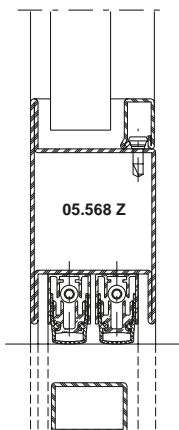

**Schallschutz**

*Der aus der Tabelle A1 abzulesende Wert für die Schalldämmung  $R_{w, Tür}$  beträgt:*

**Isolation phonique**

*La valeur à relever sur le tableau A1 concernant l'isolement contre les sons aériens  $R_{w, Porte}$  est la suivante:*

**Sound insulation**

*The value taken from table A1 for the sound insulation  $R_{w, Door}$  is:*

$$R_{w, Tür} = R_w + K_S + K_{FV} + K_{Nass} + K_{1aB} + K_{W/S} + K_{Band} + K_{G 0,4} + K_{G 1,8} + K_{G 2,6} + K_{G 3,2} \text{ dB}$$

- $R_w$**  bewertetes Schalldämm-Mass der Türe in Abhängigkeit von der Schalldämmung  $R_{w,P, Glas}$
- $R_{w,P, Glas}$**  bewertetes Schalldämm-Mass der Verglasung (Prüfwert nach ISO 140-3, mit Prüfnachweis einer PÜZ-Stelle). Alternativ können Tabellenwerte nach DIN EN 12758, Abschnitt 6 verwendet werden
- $K_S$**  Korrekturwert für zweiflügelige Türen
- $K_{FV}$**  Korrekturwert für Festverglasungen mit erhöhtem Scheibenanteil
- $K_{Nass}$**  Korrekturwert für Nassverglasung
- $K_{1aB}$**  Korrekturwert für Türen mit einer absenkbaren Bodendichtung
- $K_{Band}$**  Korrekturwert bei Verwendung von Anschlagbändern, die eine Dichtungsebene unterbrechen ( $K_{Band} = - 0,5 \text{ dB pro Band}$ )
- $K_{W/S}$**  Korrekturwert für Türen mit einer Anschlagsschwelle
- $K_{G 0,4}$**  Korrekturwert für Einzelscheiben mit einer Glasfläche  $\leq 0,4 \text{ m}^2$ . Die Korrektur gilt auch für Konstruktionen mit glasteilenden Sprossen.
- $K_{G 1,8}$**  Korrekturwert für Einzelscheiben mit einer Glasfläche  $\geq 1,8 \text{ m}^2$
- $K_{G 2,6}$**  Korrekturwert für Einzelscheiben mit einer Glasfläche  $\geq 2,6 \text{ m}^2$
- $K_{G 3,2}$**  Korrekturwert für Einzelscheiben mit einer Glasfläche  $\geq 3,2 \text{ m}^2$

- $R_w$**  Mesure d'isolement contre les sons aériens des portes évaluée suivant l'isolement phonique  $R_{w,P, Glas}$
- $R_{w,P, Glas}$**  Cote d'isolement acoustique du vitrage évalué (valeur contrôlée selon ISO 140-3 avec certificat d'un bureau de contrôle, de surveillance ou de certification). Il est également possible d'utiliser les valeurs selon le tableau DIN EN 12758, section 6
- $K_S$**  Valeur de correction pour portes à deux vantaux
- $K_{FV}$**  Valeur de correction pour vitrages fixes à fort pourcentage de vitre
- $K_{Nass}$**  Valeur de correction pour vitrage avec mastic
- $K_{1aB}$**  Valeur de correction pour portes avec un joint seuil automatique
- $K_{Band}$**  Valeur corrective en cas d'utilisation de paumelles qui interrompent un plan d'étanchéité ( $K_{Band} = - 0,5 \text{ dB par paumelle}$ )
- $K_{W/S}$**  Valeur de correction pour portes avec un seuil de butée
- $K_{G 0,4}$**  Valeur de correction pour vitres individuelles avec une surface vitrée  $\leq 0,4 \text{ m}^2$ . La correction s'applique aussi aux constructions à meneaux séparant les vitres.
- $K_{G 1,8}$**  Valeur de correction pour vitres individuelles avec surface vitrée  $\geq 1,8 \text{ m}^2$
- $K_{G 2,6}$**  Valeur de correction pour vitres individuelles avec surface vitrée  $\geq 2,6 \text{ m}^2$
- $K_{G 3,2}$**  Valeur de correction pour vitres individuelles avec surface vitrée  $\geq 3,2 \text{ m}^2$

- $R_w$**  Airborne sound reduction index of doors depending on the sound insulation  $R_{w,P, Glas}$
- $R_{w,P, Glas}$**  Airborne sound reduction index (test value in accordance with ISO 140-3, with a test certificate from a recognised testing, inspection or certification body). Alternatively, the tabulated values in DIN EN 12758, Section 6 may be used
- $K_S$**  Correction value for double-leaf doors
- $K_{FV}$**  Correction value for fixed glazing with increased proportion of pane
- $K_{Nass}$**  Correction value for glazing with sealing
- $K_{1aB}$**  Correction value for doors with a threshold gasket that can be lowered
- $K_{Band}$**  Correction value when using hinges that interrupt a sealing plane ( $K_{Band} = - 0.5 \text{ dB per hinge}$ )
- $K_{W/S}$**  Correction value for doors with a rebate threshold
- $K_{G 0,4}$**  Correction value for single panes with a glass area  $\leq 0,4 \text{ m}^2$ . The correction also applies to buildings with glazing bars
- $K_{G 1,8}$**  Correction value for single panes with a glass area  $\geq 1,8 \text{ m}^2$
- $K_{G 2,6}$**  Correction value for single panes with a glass area  $\geq 2,6 \text{ m}^2$
- $K_{G 3,2}$**  Correction value for single panes with a glass area  $\geq 3,2 \text{ m}^2$



# METALFORM

MASTERS OF METAL

**UNITED KINGDOM**

**METALFORM**

**NORWAYMETAL LTD**

53 Chelsea Manor Street  
London, SW3 5RZ

**SALES@METALFORM.UK**

**+44 20 81298814**

**GERMANY**

**METALFORM GMBH**

Carl-Zeiss-Ring 15A  
85737 Ismaning

**SALES@METALFORMGROUP.DE**

**+49 17663630406**

**NORWAY**

**METALFORM AS**

Brochmannsveien 2  
1950 Rømskog

**SALG@METALFORM.NO**

**+47 401 62 446**

**METALFORMGROUP**

**SALES@METALFORMGROUP.COM**