

Janisol HI Fenster

Hochwärmegedämmte Fenster und Verglasungen aus Stahl

Fenêtres Janisol HI

Fenêtres et vitrages fixes en acier à haute rupture de pont thermique

Janisol HI windows

Highly thermally insulated windows and fixed lights in steel

Grafische Planungsdaten wie z.B. Anwendungsbeispiele, Konstruktionsdetails, Anschlüsse am Bau, die in unseren physischen oder elektronischen Dokumentationsunterlagen enthalten sind, sind schematische Darstellungen. Gleiches gilt für digitale Medien wie CAD Dateien oder BIM Modelle.

Sie sollen den ausführenden Metallbauer und/oder Fachplaner bei der Planung und Ausführung eines Projektes unterstützen. Sie sind im konkreten Anwendungsfall durch den ausführenden Metallbauer und/oder Fachplaner auf die Verwendbarkeit im konkreten betroffenen Projekt hinsichtlich rechtlichen/regulatorischen aber auch technischen objektspezifischen Anforderungen zu überprüfen und ggfs. eigenverantwortlich anzupassen.

Bei der Überprüfung, der spezifischen Planung und der Umsetzung sind die objektspezifischen Rahmenbedingungen (Material der Bausubstanz, Dimension des Einbauelements, Farbe, Exposition, Lasteinwirkung, etc.) sowie der geltende Stand der Technik einschliesslich aller anwendbaren Normen und technischen Richtlinien eigenverantwortlich zu beachten.

Falls das vorliegende Dokument Differenzen zur aktuellen deutschen Version (Artikel Nr. K1214220) aufweist, gilt in jedem Fall der deutsche Originaltext in der jeweils geltenden Fassung im Jansen Docu Center.

Alle Ausführungen dieser Dokumentation haben wir sorgfältig und nach bestem Wissen zusammengestellt. Wir können aber keine Verantwortung für die Benutzung der vermittelten Vorschläge und Daten übernehmen. Wir behalten uns technische Änderungen ohne Vorankündigung vor.

Les données de planification graphiques, comme les exemples d'application, détails de construction et raccordements au bâtiment, fournies dans notre documentation physique et numérique sont des représentations schématiques. Il en va de même pour les médias numériques comme les fichiers CAD ou modèles BIM.

Leur but est de faciliter la planification et réalisation d'un projet par les constructeurs métalliques et/ou concepteurs. Concrètement, elles doivent être vérifiées par le constructeur métallique et/ou le concepteur et, le cas échéant, modifiées de son propre chef pour s'assurer qu'elles concordent avec le projet concerné et qu'elles répondent aux exigences techniques spécifiques ainsi qu'aux dispositions légales et réglementaires.

Lors de la vérification, de la planification spécifique et de la mise en œuvre, il y a lieu de tenir compte des conditions spécifiques à l'objet (matériaux du bâtiment, dimension de l'élément d'insert, couleur, exposition, effet de charge, etc.) ainsi que de l'état actuel de la technique, y compris toutes les normes et directives techniques applicables.

En cas de divergence entre le présent document et la version allemande (no d'article K1214220), c'est dans tous les cas le texte original allemand qui prévaut dans sa version actuelle disponible dans le Jansen Docu Center.

Nous avons apporté le plus grand soin à l'élaboration de cette documentation. Cependant, nous déclinons toute responsabilité pour l'utilisation faite de nos propositions et de nos données.

Nous nous réservons le droit de procéder à des modifications techniques sans préavis.

Graphical planning data such as application examples, construction details, connections on site that are contained in our physical or electronic documentation components are schematic representations. The same applies to digital media such as CAD files or BIM models.

They are intended to support the metal worker and/or design engineer in planning and executing projects. In the specific case of application they are to be checked by the metal worker and/or design engineer in terms of their usability in the specific project concerned with regard to legal/regulatory and technical property-specific requirements and adjusted if necessary at the latter's own responsibility.

The property-specific underlying conditions (construction material, dimensions of installation element, colour, exposure, load effect etc.) and current state of the art including all applicable norms and technical guidelines are to be taken into consideration at the metal worker and/or design engineer's own responsibility during the review, specific planning and implementation.

If there are any differences between this document and the current German version (item number K1214220), the latest version of the original German text in the Jansen Docu Center shall prevail.

All the information contained in this documentation is given to the best of our knowledge and ability. However, we decline all responsibility for the use made of these suggestions and data.

We reserve the right to effect technical modifications without prior warning.

Inhaltsverzeichnis
Sommaire
Content

Janisol HI Fenster
Janisol HI fenêtres
Janisol HI windows

Systemübersicht

Merkmale
Leistungseigenschaften
Systemausführungen
Typenübersicht

Sommaire du système

Caractéristiques
Caractéristiques de performance
Exécutions de système
Sommaire des types

Summary of system

Characteristics
Performance characteristics
System versions
Summary of types

2

Profilsortiment

Assortiment de profilé

Range of profiles

9

Beispiele

Schnittpunkte
Konstruktionsdetails
Anschlüsse am Bau

Exemples

Coupes de détails
Détails de construction
Raccords au mur

Examples

Section details
Construction details
Attachment to structure

12

Leistungseigenschaften

Caractéristiques de performance

Performance characteristics

38

Merkmale
Caractéristiques
Characteristics

Janisol HI Fenster
Janisol HI fenêtres
Janisol HI windows

- Hervorragende wärmetechnische Eigenschaften für maximale Anforderungen
- Bautiefe Flügel 90 mm, Festverglasung 80 mm
- Schmale Profilansichten: Rahmen 50 resp. 70 mm, Pfosten/Riegel 70 resp. 90 mm, Flügel 35 mm, Stulpflügelpartie 110 mm
- Isolierstege mit besten bauphysikalischen Eigenschaften aus glasfaserverstärktem Kunststoff
- Mit Euro-Beschlagsnute für Dreh-, Drehkipp-, Stulp- und Kippflügel-Fenster
- Fensterflügel Größen bis max. 2800 mm Höhe
- Fensterflügel-Gewichte: verdeckt liegend bis 180 kg, aufgesetzt bis 150 kg
- Glasdicke für Fensterflügel 24-67 mm, für Festverglasung 24-57 mm
- Systemprüfung nach Produktnorm EN 14351-1 für alle Fenster-Öffnungsarten
- Sehr gute statische Werte, hohe mechanische Festigkeiten
- Dauerfunktionsprüfung nach EN 12400 Drehfenster Klasse 4 Drehkippfenster Klasse 3
- Für Nasslack- oder Pulverbeschichtung geeignet
- Excellentes propriétés thermiques répondant à des exigences maximum
- Profondeur de montage vantail 90 mm, vitrage fixe 80 mm
- Profilés très fins: Cadre 50 et 70 mm, montant/traverse 70 ou 90 mm, vantail 35 mm, partie à deux vantaux à la française 110 mm
- Traverses isolantes aux excellentes propriétés physiques en matière plastique renforcé par fibres de verre
- Avec rainure de ferrure Euro pour fenêtres à la française, oscillo-battantes, à deux vantaux et à soufflet
- Tailles d'ouvrant de fenêtre jusqu'à max. 2800 mm de hauteur
- Poids des ouvrants de fenêtre: non apparents jusqu'à 180 kg, plaqués jusqu'à 150 kg
- Épaisseur de vitrage pour ouvrants de fenêtre 24-67 mm, pour vitrage fixe 24-57 mm
- Contrôle du système selon la norme produit EN 14351-1 pour tous les types d'ouverture de fenêtre
- Très bonnes valeurs statiques, résistances mécaniques élevées
- Durabilité mécanique selon EN 12400 Fenêtres à la française classe 4 Fenêtres oscillo-battantes classe 3
- Convient au revêtement à la peinture liquide ou poudre
- Outstanding thermal properties for the most exacting requirements
- Basic depth of vent 90 mm, fixed glazing 80 mm
- Narrow profile face widths: frame 50 or 70 mm, mullion/transom 70 or 90 mm, vent 35 mm, double-vent meeting stile assembly 110 mm
- Insulating bars with optimum structural properties made from glass fibre-reinforced plastic
- With Euro fittings groove for side-hung, turn/tilt, double-vent and bottom-hung windows
- Window vent dimensions up to max. 2800 mm in height
- Window vent weights: concealed up to 180 kg, surface-mounted up to 150 kg
- Glass thickness for window vent 24-67 mm, for fixed glazing 24-57 mm
- System testing in accordance with product standard EN 14351-1 for all window opening types
- Excellent structural values, high levels of mechanical strength
- Mechanical durability in accordance with EN 12400 Side-hung windows class 4 Turn/tilt windows class 3
- Suitable for wet paint or powder coating

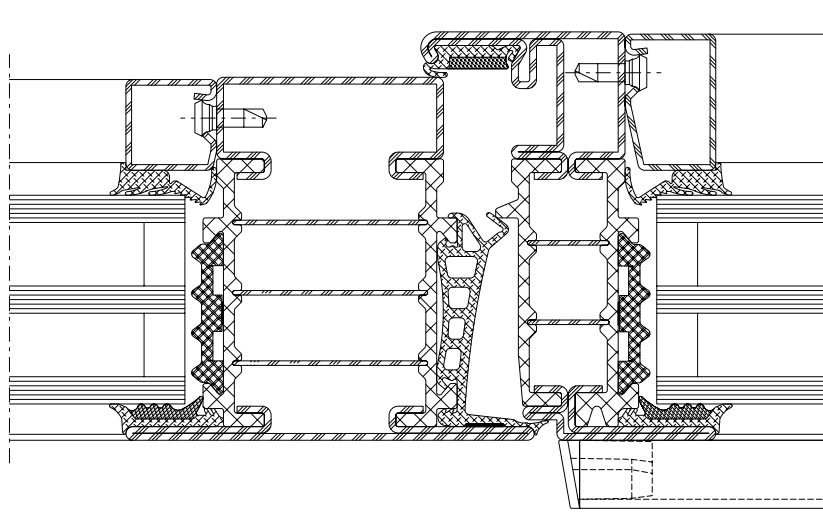

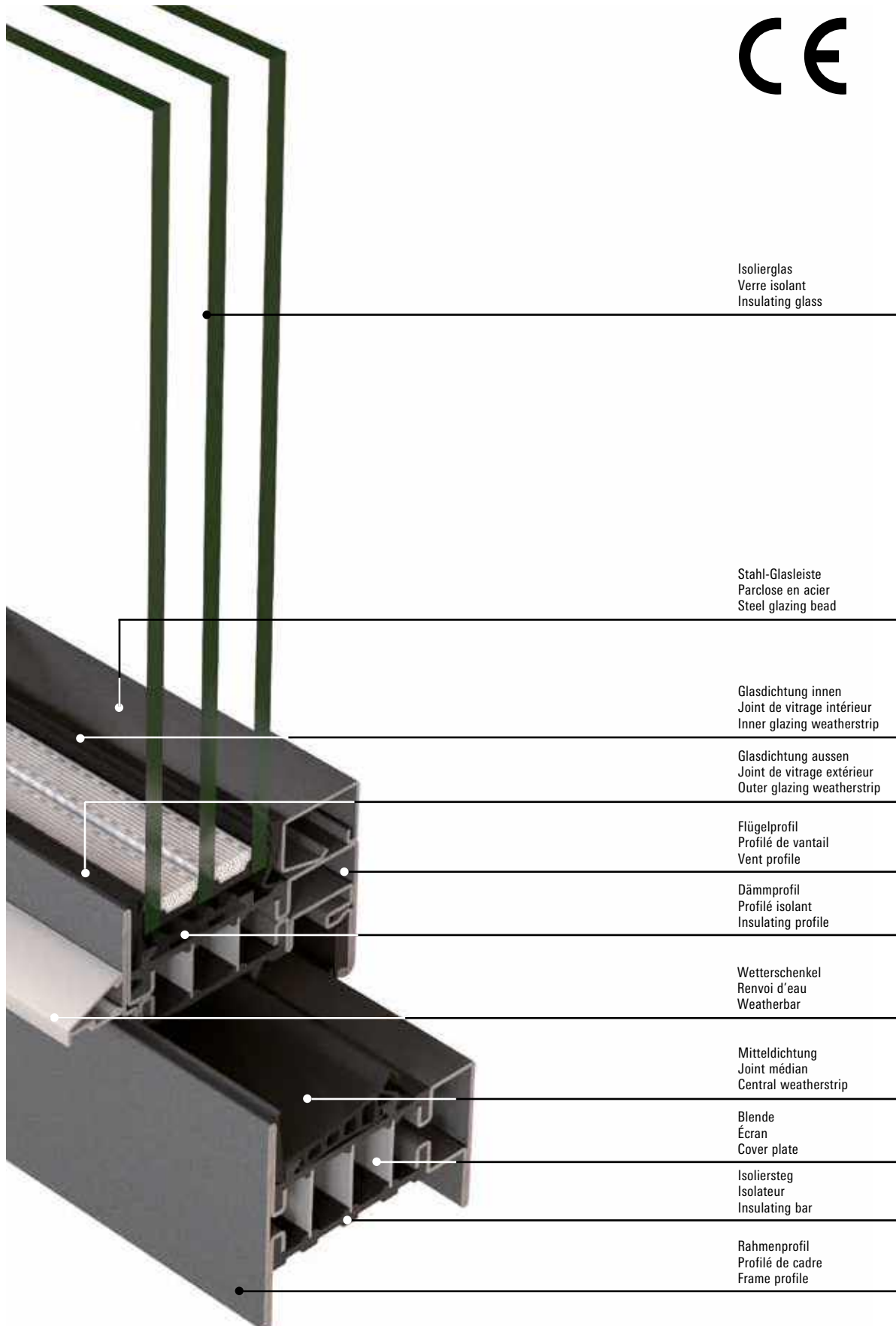

Isolierglas
Verre isolant
Insulating glass

Stahl-Glasleiste
Parclose en acier
Steel glazing bead

Glasdichtung innen
Joint de vitrage intérieur
Inner glazing weatherstrip

Glasdichtung aussen
Joint de vitrage extérieur
Outer glazing weatherstrip

Flügelprofil
Profilé de vantail
Vent profile

Dämmprofil
Profilé isolant
Insulating profile













Wetterschenkel
Renvoi d'eau
Weatherbar

Mitteldichtung
Joint médian
Central weatherstrip

Blende
Écran
Cover plate

Isoliersteg
Isolateur
Insulating bar

Rahmenprofil
Profilé de cadre
Frame profile

Norm	Eigenschaft Caractéristique Characteristic	Klassifizierung/Wert Classification / Valeur Classification / Value																
		npd	C1 (400)	C2 (800)	C3 (1200)	C4 (1600)	C5 (2000)	1A (0)	2A (50)	3A (100)	4A (150)	5A (200)	6A (250)	7A (300)	8A (450)	9A (600)	Exxx (>750)	
 EN 12210	Widerstandsfähigkeit bei Windlast Résistance à la pression du vent Resistance to wind load	npd	C1 (400)	C2 (800)	C3 (1200)	C4 (1600)	C5 (2000)											
 EN 12208	Schlagregendichtheit Étanchéité à la pluie battante Watertightness	npd	1A (0)	2A (50)	3A (100)	4A (150)	5A (200)	6A (250)	7A (300)	8A (450)	9A (600)	Exxx (>750)						
 EN ISO 10140	Schalldämmung R_w (C, C_{tr}) (dB) Isolation phonique R_w (C, C_{tr}) (dB) Sound insulation R_w (C, C_{tr}) (dB)	npd	bis R_w 46 dB (-2; -6) jusqu'à R_w 46 dB (-2; -6) up to R_w 46 dB (-2; -6)															
 EN ISO 10077-2	Wärmedurchgangskoeffizient U_f (W/(m ² ·K)) Transmission thermique U_f (W/(m ² ·K)) Thermal production U_f (W/(m ² ·K))	npd	ab 0,74 W/m ² ·K à partir de 0,74 W/m ² ·K from 0,74 W/m ² ·K															
 EN 12207	Luftdurchlässigkeit Perméabilité à l'air Air permeability	npd	1 (150)	2 (300)	3 (600)	4 (600)												
 EN 14024	Tragfähigkeit von Sicherheitsvorrichtungen Capacité portante des dispositifs de sécurité Load-bearing capacity of safety devices		Anforderung erfüllt Exigence remplie Requirement satisfied															
 EN 14024	Metallprofile mit thermischer Trennung Profilés en métal. avec rupture de pont thermique Metal profiles with thermal barrier		CW / TC2															
 EN 12400	Dauerfunktionsprüfung Durabilité mécanique Mechanical durability		D 1 5'000	2 10'000	3 20'000	4 50'000	5 100'000	6 200'000	7 500'000	8 1'000'000								
 EN 13115	Bedienkräfte Forces de manœuvre Operating forces	npd	0	1	2													
 EN 1627	Einbruchhemmung Anti-effraction Burglar resistance	npd	1	2	3	4	5	6										
 ISO 16000	Gefährliche Substanzen Substances dangereuses Dangerous substances	npd	Anforderung erfüllt Exigence remplie Requirement satisfied															
 DIN 18008-4	Vorgefertigte absturzsichernde Verglasung Vitrage anti-chutes préfabriqué Prefabricated glazing suitable for safety barrier loading												Anhang D.1.2 erfüllt Annexe D.1.2 remplie Appendix D.1.2 satisfied					

npd = keine Leistung festgestellt
(no performance determined)

npd = Aucune performance déterminée
(no performance determined)

npd = no performance determined



Einbruchhemmende Janisol HI Fenster

- Flügelgrößen bis 1475 x 2800 mm
- Dreh-, Drehkipp-, Stulpfenster und Festverglasungen
- Beschlag als Komplettseinheit geliefert
- Prüfungen nach EN 1627 bis 1630 bis RC3

Fenêtres anti-effraction Janisol HI

- Dimensions de vantail jusqu'à 1475 x 2800 mm
- Fenêtres ouvrant à la française, oscillo-battantes, à deux vantaux et vitrages fixes
- Ferrures livrées comme unité complète
- Contrôlé selon les normes EN 1627 à 1630 jusqu'à RC3

Burglar-resistant Janisol HI windows

- Vent sizes up to 1475 x 2800 mm
- Side-hung, turn/tilt and double-vent windows and fixed glazing
- Fitting supplied as complete unit
- Tests in accordance with EN 1627 to 1630 up to RC3

Jansen Docu Center

Die Plattform zum effizienten Arbeiten mit Jansen Dokumentationen. Im Jansen Docu Center stehen alle Produktinformationen jederzeit digital in der aktuellsten Version zur Verfügung: von Architekten-Informationen über Bestell- und Fertigungskatalogen bis hin zu Anleitungen und Prospekten sowie Videos.

Die Inhalte können einfach und schnell aufgerufen werden. Ein für den Anwender komfortables papierloses Arbeiten, das zahlreiche Vorteile bietet.

Download CAD Daten

DXF

DWG

Sie können die Zeichnungen in den Formaten DXF und/oder DWG herunterladen. Klicken Sie auf das entsprechende Icon und der Download erfolgt.

Die Hinweise «Artikelbibliothek/Türbeschläge/Fensterbeschläge» bedeuten, dass Sie mit einem Klick die gesamte Artikelbibliothek des entsprechenden Systems herunterladen (Profile, Beschläge, Glasleisten, Zubehör etc.).

Info und Beratung

Gerne beraten wir Sie persönlich und stehen Ihnen bei Fragen zur Verfügung. Bitte schreiben Sie uns Ihre Anliegen an: info@jansen.com

Jansen Docu Center

La plate-forme pour travailler efficacement avec les documentations Jansen. Le Jansen Docu Center met à votre disposition les informations sur les produits, en format numérique et dans une version actualisée: des catalogues de commande et de fabrication aux instructions et prospectus, en passant par les informations destinées aux architectes et vidéos.

Les contenus sont facilement et rapidement accessibles. Une manière de travailler confortable et offrant de nombreux avantages.

Télécharger fichiers DAO

DXF

DWG

Vous pouvez télécharger les dessins aux formats DXF et/ou DWG. Cliquez sur l'icône correspondante et le téléchargement s'effectuera.

Les indications «Bibliothèque des articles/Ferures de porte/Ferrures de fenêtres» signifie que vous téléchargez la totalité de la bibliothèque des articles du système donné (profilés, ferrures, parcloles, accessoires etc.).

Info et conseils

Nous vous conseillons volontiers individuellement et sommes à votre disposition si vous avez des questions à poser. Veuillez nous envoyer votre requête à: info@jansen.com

Jansen Docu Center

The platform for working efficiently with Jansen documentation. The latest version of all the product information is available digitally at any time in the Jansen Docu Center – from order and fabrication manuals to architect information, instructions and brochures and videos.

The content can be retrieved quickly and easily. The user can work conveniently without paper, which has numerous benefits.

Download CAD files

DXF

DWG

You can download the drawings in DXF and/or DWG format. Click on the relevant icon to begin the download.

The items «Article library/Door fittings/Window fittings» means that you download the entire article library for the corresponding system with one click (profiles, fittings, glazing beads, accessories etc.).

Information and advice

We would be delighted to provide you with advice in person and are available to answer any questions you may have. Please write to us with your queries at: info@jansen.com

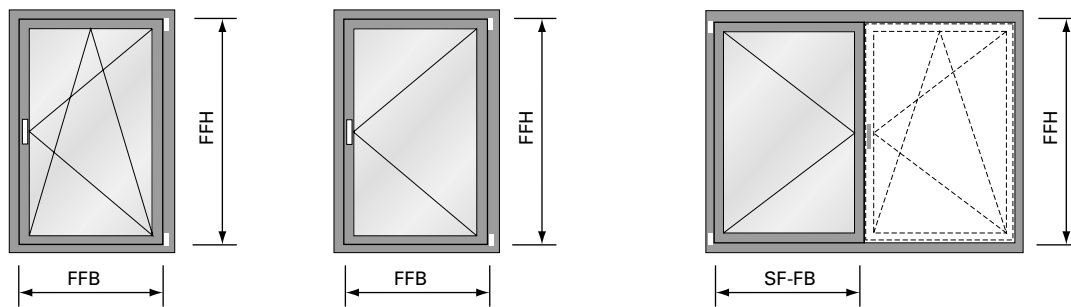

*Flügelgrößen Drehkipp-,
 Drehfenster und Stulpfenster:*

Max.	FFH = 2760 mm
	FFB = 1435 mm
	SF-FB = 1435 mm
Min.	FFH = 600 mm
	FFB = 600 mm
	SF-FB = 370 mm*
	SF-FB = 480 mm**
Max. Fläche:	3.0 m ²
Max. Gewicht:	180 kg
FFB/FFH:	≤ 2

*Grandeurs du vantail fenêtre
 oscillo-battante, à la française et
 fenêtre à deux vantaux:*

Max.	FFH = 2760 mm
	FFB = 1435 mm
	SF-FB = 1435 mm
Min.	FFH = 600 mm
	FFB = 600 mm
	SF-FB = 370 mm*
	SF-FB = 480 mm**
Surface max.:	3.0 m ²
Poids max.:	180 kg
FFB/FFH:	≤ 2

*Size of sash turn/tilt, side-hung and
 double-sash windows:*

Max.	FFH = 2760 mm
	FFB = 1435 mm
	SF-FB = 1435 mm
Min.	FFH = 600 mm
	FFB = 600 mm
	SF-FB = 370 mm*
	SF-FB = 480 mm**
Max. surface:	3.0 m ²
Max. weight:	180 kg
FFB/FFH:	≤ 2

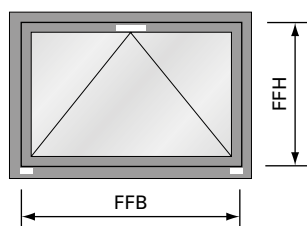

Flügelgröße Kipp-Fenster:

Max.	FFH = 2760 mm
	FFB = 2760 mm
Min.	FFH = 600 mm
	FFB = 600 mm
Max. Fläche:	3.0 m ²
Max. Gewicht:	80 kg
	(2 Bänder)
	120 kg
	(3 Bänder)
FFB/FFH:	≤ 2

*Grandeur du vantail fenêtre à
 soufflet:*

Max.	FFH = 2760 mm
	FFB = 2760 mm
Min.	FFH = 600 mm
	FFB = 600 mm
Surface max.:	3.0 m ²
Poids max.:	80 kg
	(2 paumelles)
	120 kg
	(3 paumelles)
FFB/FFH:	≤ 2

Size of sash bottom-hung window:

Max.	FFH = 2760 mm
	FFB = 2760 mm
Min.	FFH = 600 mm
	FFB = 600 mm
Max. surface:	3.0 m ²
Max. weight:	80 kg
	(2 hinges)
	120 kg
	(3 hinges)
FFB/FFH:	≤ 2

* Standard-Fensterbeschlag
 ** Verdeckt liegender Fensterbeschlag

* Ferrure de fenêtre Standard
 ** Ferrure de fenêtre non apparente

* Standard window fitting
 ** Concealed window fitting

Empfehlung Jansen:
 Flügelhöhe und Flügelbreite 1 mm ins
 Minus schneiden betreffend Sollmass.

Recommandation Jansen:
 Couper la hauteur et la largeur de
 vantail à 1 mm de moins que la cote
 de consigne.

Jansen recommendation:
 Cut sash height and sash width 1 mm
 into the minus relative to the target
 dimension.

Typenübersicht
Sommaire des types
Summary of types

Janisol HI Fenster
Janisol HI fenêtres
Janisol HI windows

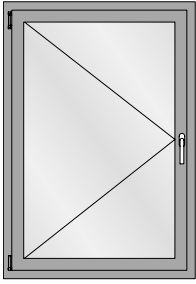

Drehflügel
 Fenêtre à la française
 Side-hung window

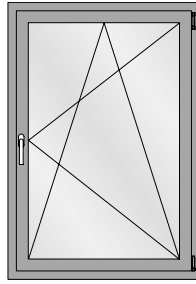

Drehkipp-Flügel
 Vantail oscillo-battant
 Turn/tilt window

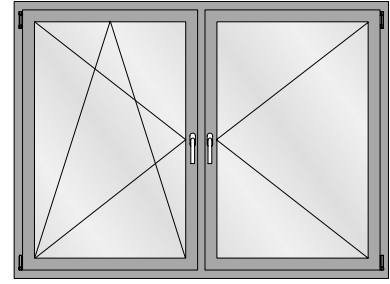

Drehkipp/Drehflügel (mit Pfosten)
 Vantail oscillo-battant/fenêtre à la française
 (avec montant)
 Side-hung/turn/tilt window (with mullion)

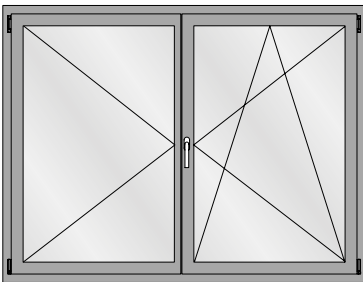

Drehkipp/Drehflügel (Stulpfenster)
 Vantail oscillo-battant/fenêtre à la française
 (Fenêtre à deux vantaux)
 Side-hung/turn/tilt window (Double-vent window)

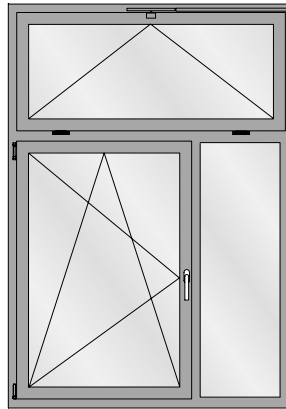

Drehkipp-Flügel mit Festverglasung und Oberlicht
 Vantail oscillo-battant avec vitrage fixe et imposte
 Turn/tilt window with fixed lights and top lights

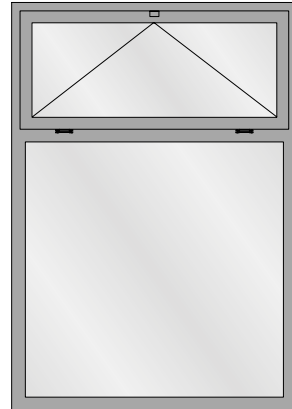

Festverglasung mit Oberlicht
 Vitrage fixe avec imposte
 Fixed lights with top light

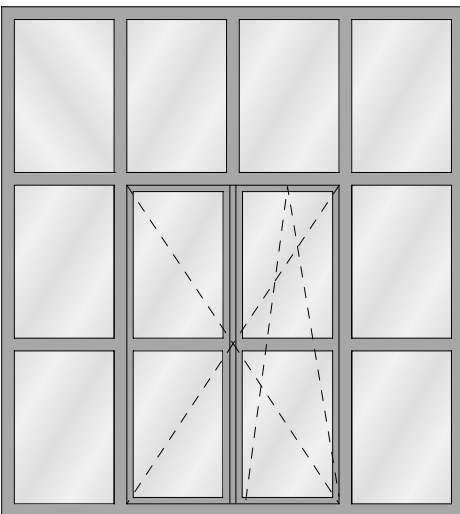

Drehkipp-Flügel mit Festverglasung
 Vantail oscillo-battant avec vitrage fixe et imposte
 Turn/tilt window with fixed lights and top lights



Festverglasung mit Rundbogen
 Vitrage fixe avec demi-rond
 Fixed lights with round arched

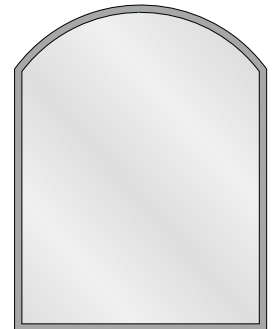
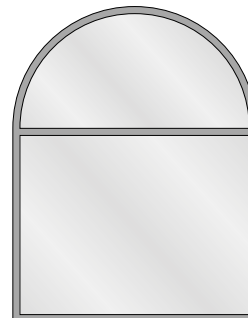

Profilübersicht
Sommaire des profilés
Summary of profiles

Janisol HI Fenster
 Janisol HI fenêtres
 Janisol HI windows

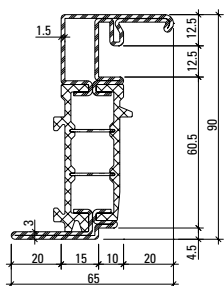

680.900 Z

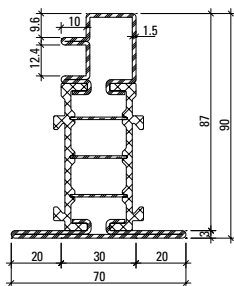

680.901 Z

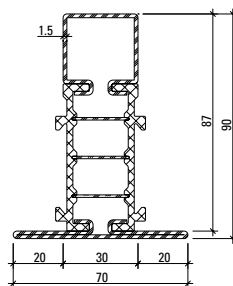

680.902 Z

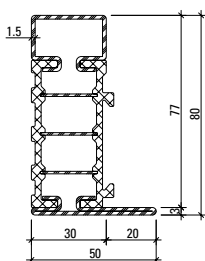

681.630 Z

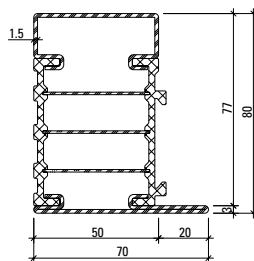

681.650 Z

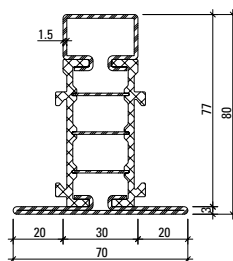

682.630 Z

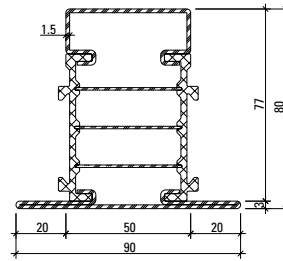

682.650 Z

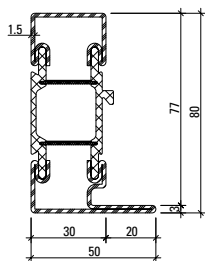

681.635 Z*

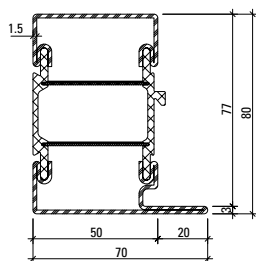

681.655 Z*

*in Kombination mit Bogen
 *en combinaison avec des cintres
 *in combination with arched design

Profil-Nr.	G kg/m	I _x cm ⁴	W _x cm ³	I _y cm ⁴	W _y cm ³	U m ² /m
681.630 Z	3,713	25,83	5,65	5,61	1,85	0,297
681.650 Z	4,331	32,30	7,21	15,97	4,04	0,337
682.630 Z	4,194	31,56	6,24	9,87	2,82	0,352
682.650 Z	4,816	38,99	7,94	24,03	5,34	0,392
680.900 Z	4,735					0,388
680.901 Z	4,618					0,390
680.902 Z	4,426	38,56	6,90	10,73	3,07	0,372
681.635 Z	3,784	26,93	5,71	7,49	2,42	0,310
681.655 Z	4,286	33,47	7,25	21,06	5,28	0,348

Artikelbibliothek
 Bibliothèque des articles
 Article library

DXF **DWG**

Profilübersicht
Sommaire des profilés
Summary of profiles

Janisol HI Fenster
 Janisol HI fenêtres
 Janisol HI windows

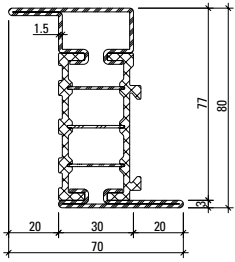

683.630 Z

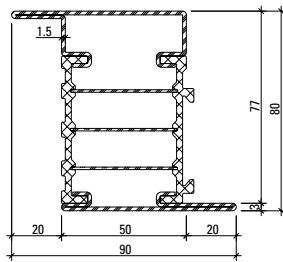

683.650 Z

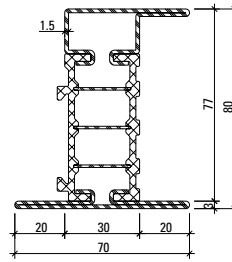

685.630 Z

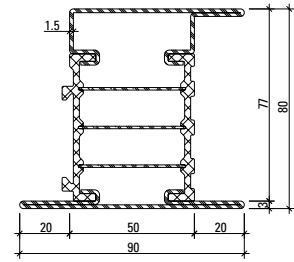

685.650 Z

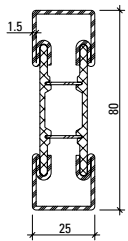

600.012
600.012 Z

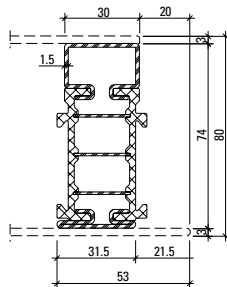

680.060 Z



Werkstoffe

Artikel-Nr.

ohne Zusatz = blank

mit Z = bandverzinkter Stahl

Isolator = glasfaserverstärkter Kunststoff

Matériaux

No. d'article

sans supplément = brut

avec Z = bande d'acier zinguée

Isolateur = matière plastique renforcé par fibres de verre

Materials

Part no.

without addition = bright

with Z = strip galvanised steel

Insulator = glassfibre reinforced plastic

Profil-Nr.	G kg/m	Ix cm ⁴	Wx cm ³	Iy cm ⁴	Wy cm ³	U m ² /m
683.630 Z	4,170	32,73	7,98	10,09	2,88	0,336
683.650 Z	4,787	38,93	9,50	24,43	5,42	0,376
685.630 Z	4,637	38,31	8,65	13,46	3,51	0,374
685.650 Z	5,258	47,62	10,93	30,13	6,14	0,415
600.012	3,254	19,67	4,92	2,93	2,34	0,224
680.060 Z	3,214	17,21	4,55	2,54	1,48	0,266

Bogenfenster
Fenêtres cintrées
Arched windows

Janisol HI Fenster
 Janisol HI fenêtres
 Janisol HI windows

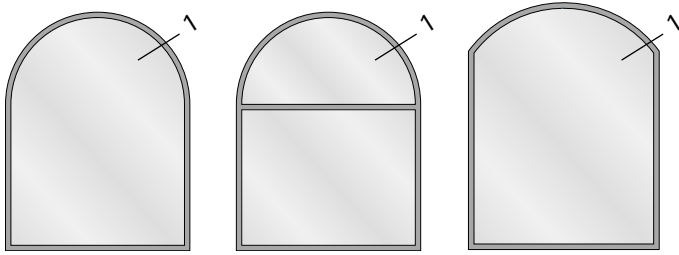

Stahl-Glasleisten	Min. Radius
Parcloses en acier	Rayon min.
Steel glazing beads	Min. radius
	R



402.112 Z	500 mm
402.115 Z	500 mm
402.120 Z	600 mm
402.125 Z	750 mm
402.130 Z	1000 mm
402.136 Z	500 mm
402.141 Z	500 mm

Stahl-Glasleisten	Min. Radius
Parcloses en acier	Rayon min.
Steel glazing beads	Min. radius
	R



62.507 Z	300 mm
62.508 Z	300 mm
62.509 Z	300 mm

Aluminium-Glasleisten	Min. Radius
Parcloses en aluminium	Rayon min.
Aluminium glazing beads	Min. radius
	R



404.112	400 mm
404.115	400 mm
404.120	400 mm
404.125	450 mm
404.130	500 mm
404.135	600 mm

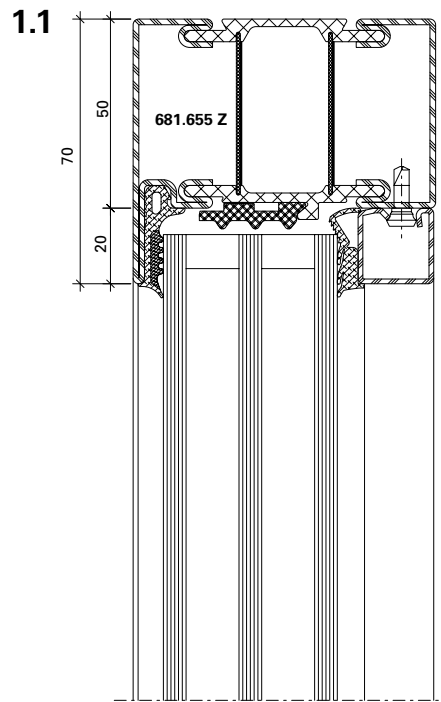
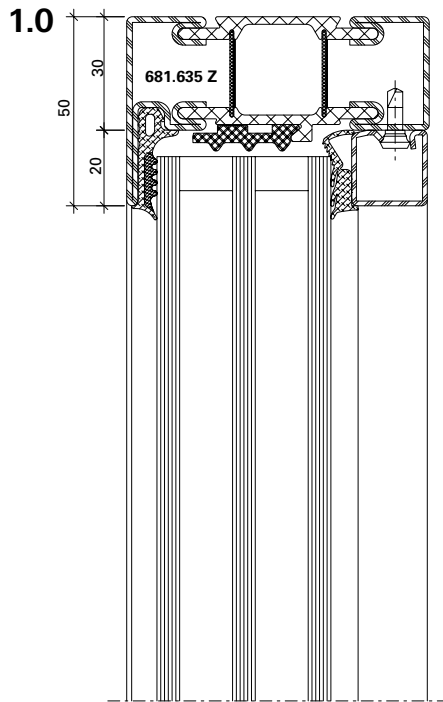

Profil	Min. Radius
Profilé	Rayon min.
Profile	Min. radius
	R

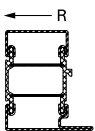

681.635 Z	700 mm
681.655 Z	750 mm

Andere Profiltypen sowie im Grundriss gebogene Profile auf Anfrage.

Autres types de profilés et profilés au tracé cintré sur demande.

Other profile types and profiles curved in the floor plan are available on request.

Die Radien-Angaben beziehen sich auf die Fertigung im Hause Jansen.

Les rayons indiqués concernent la fabrication des cintres par la société Jansen.

The radius information refers to the production of the arches at the Jansen.

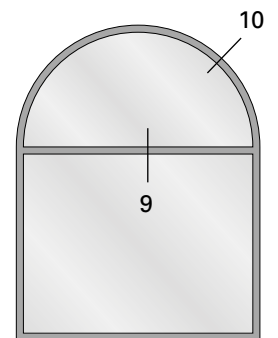
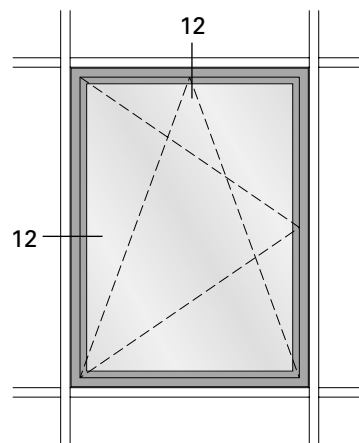
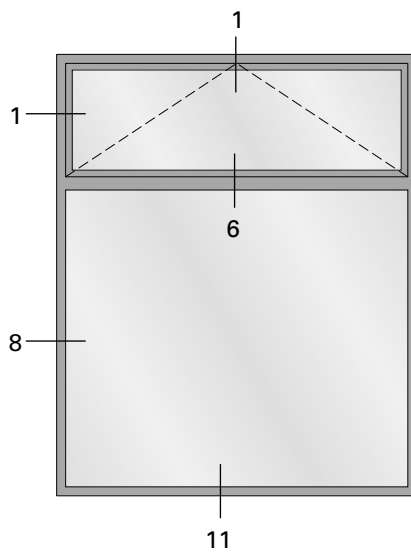
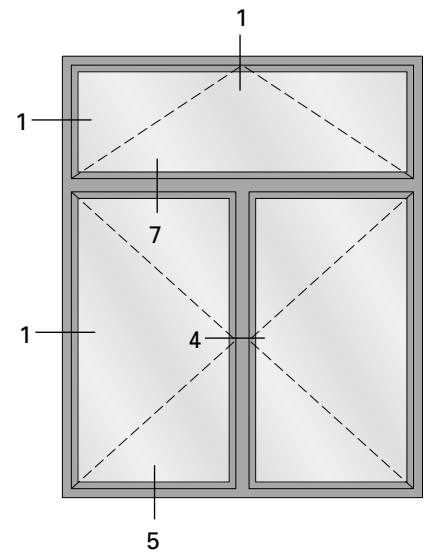
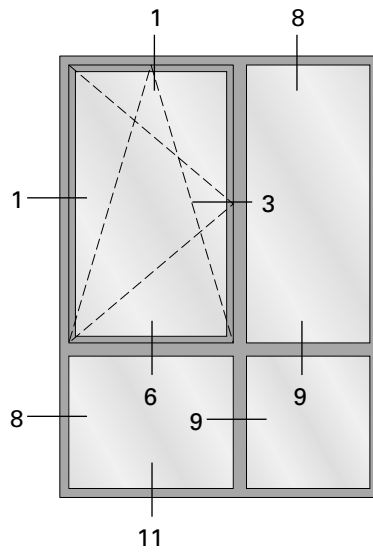
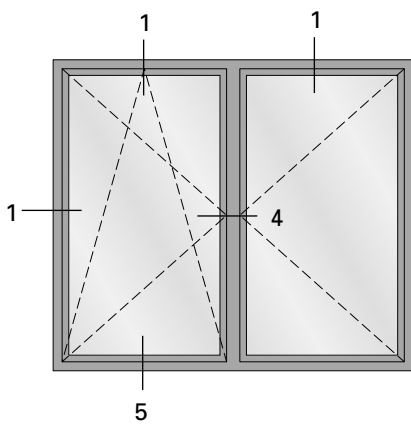
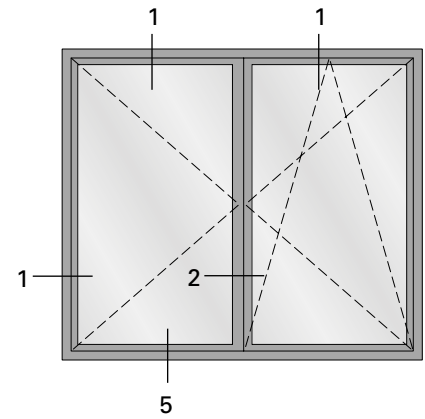
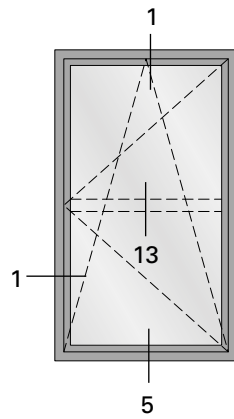
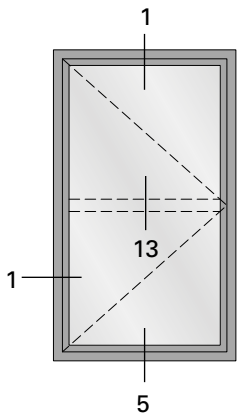

1.0

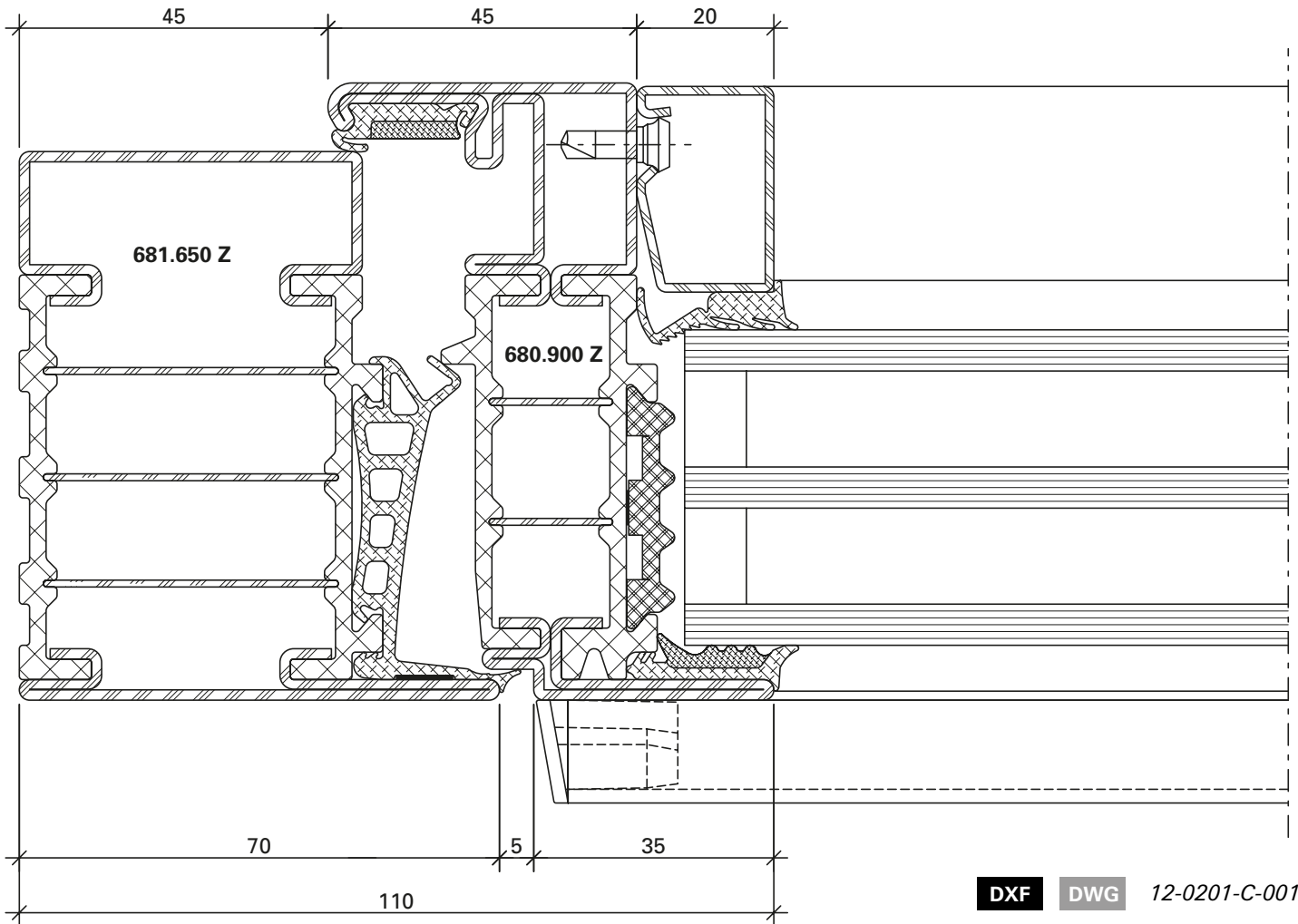

DXF

DWG

12-0201-C-001

1.1

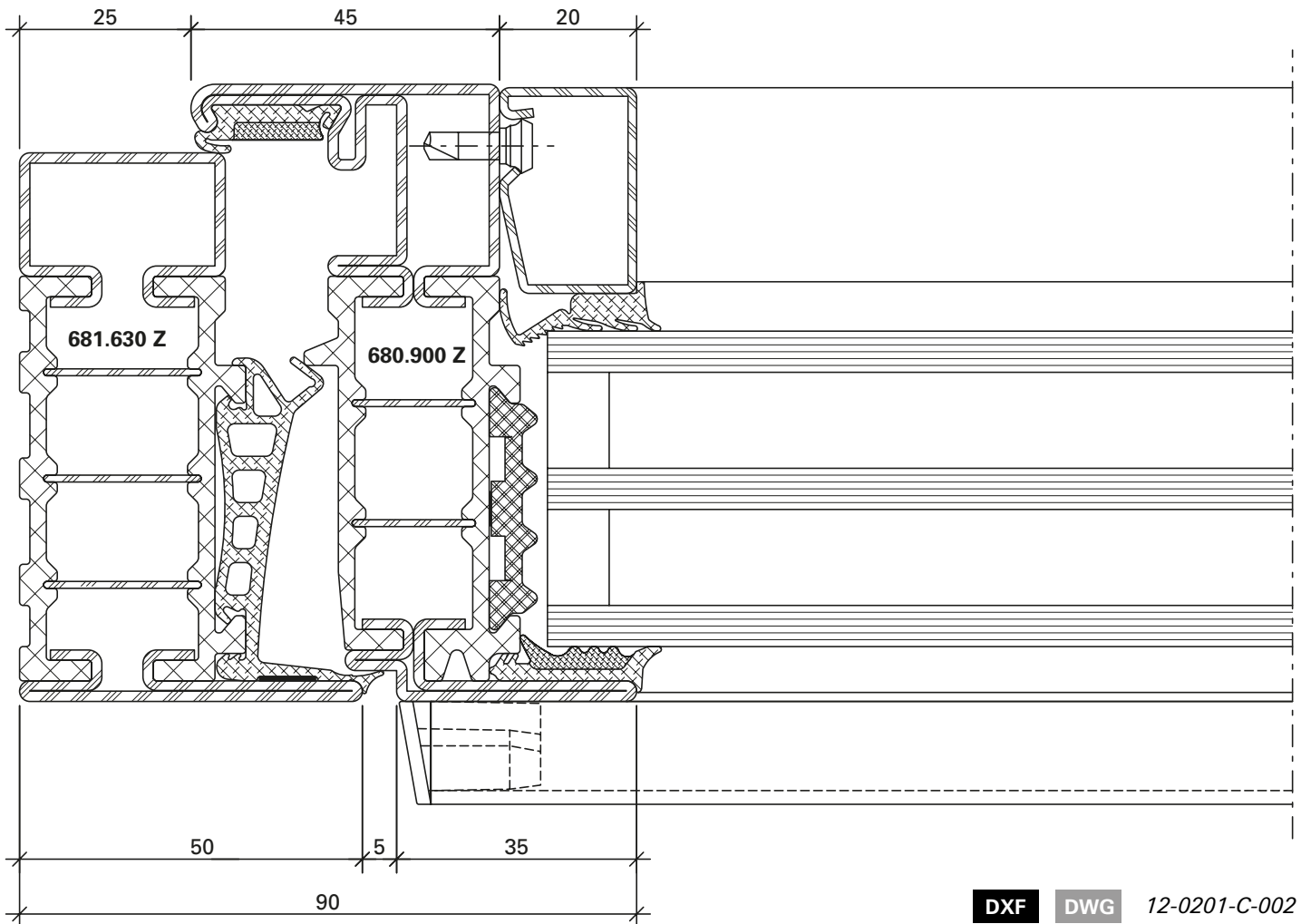

DXF

DWG

12-0201-C-002

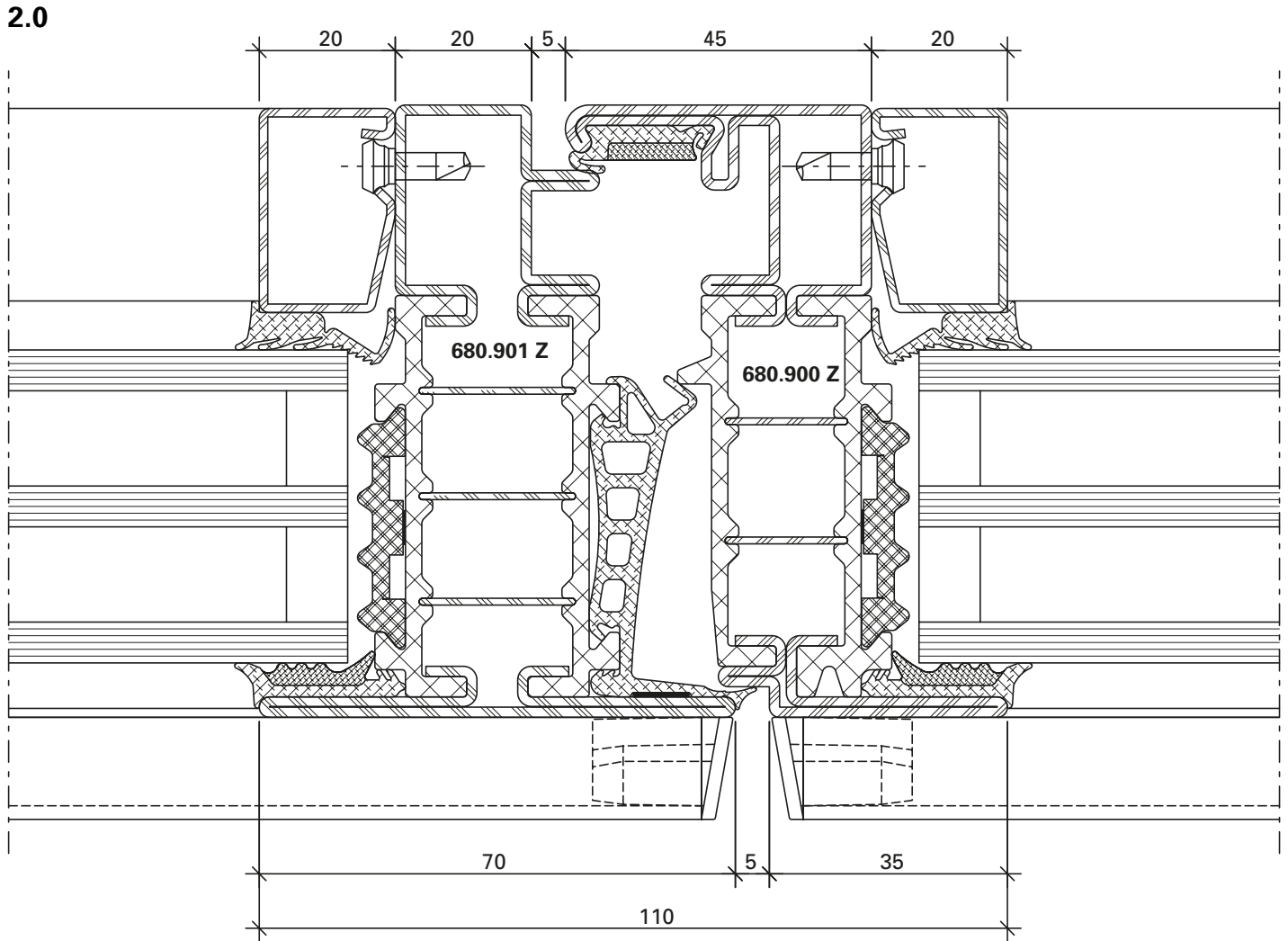

DXF DWG 12-0201-C-007

3.0

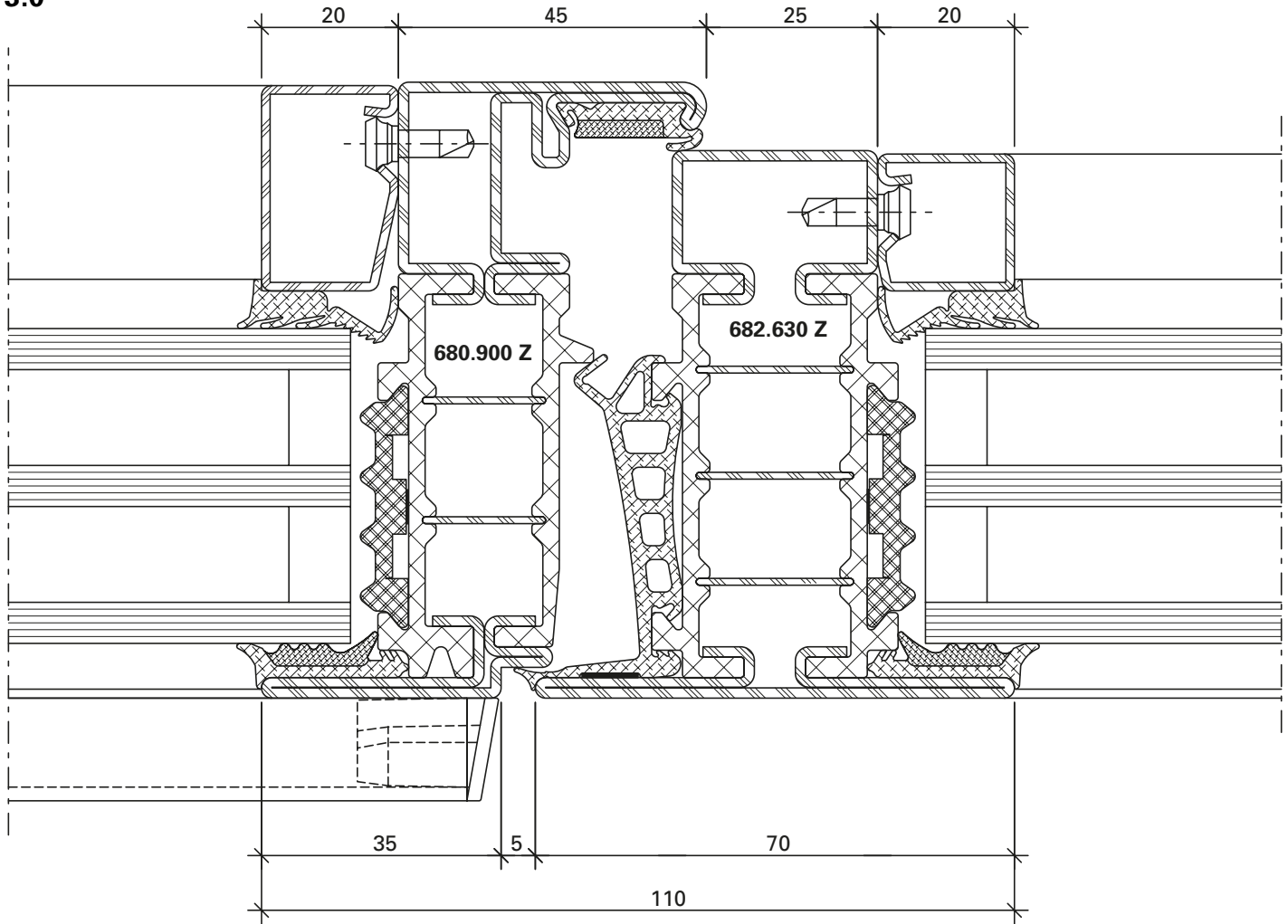

DXF DWG 12-0201-C-004

4.0

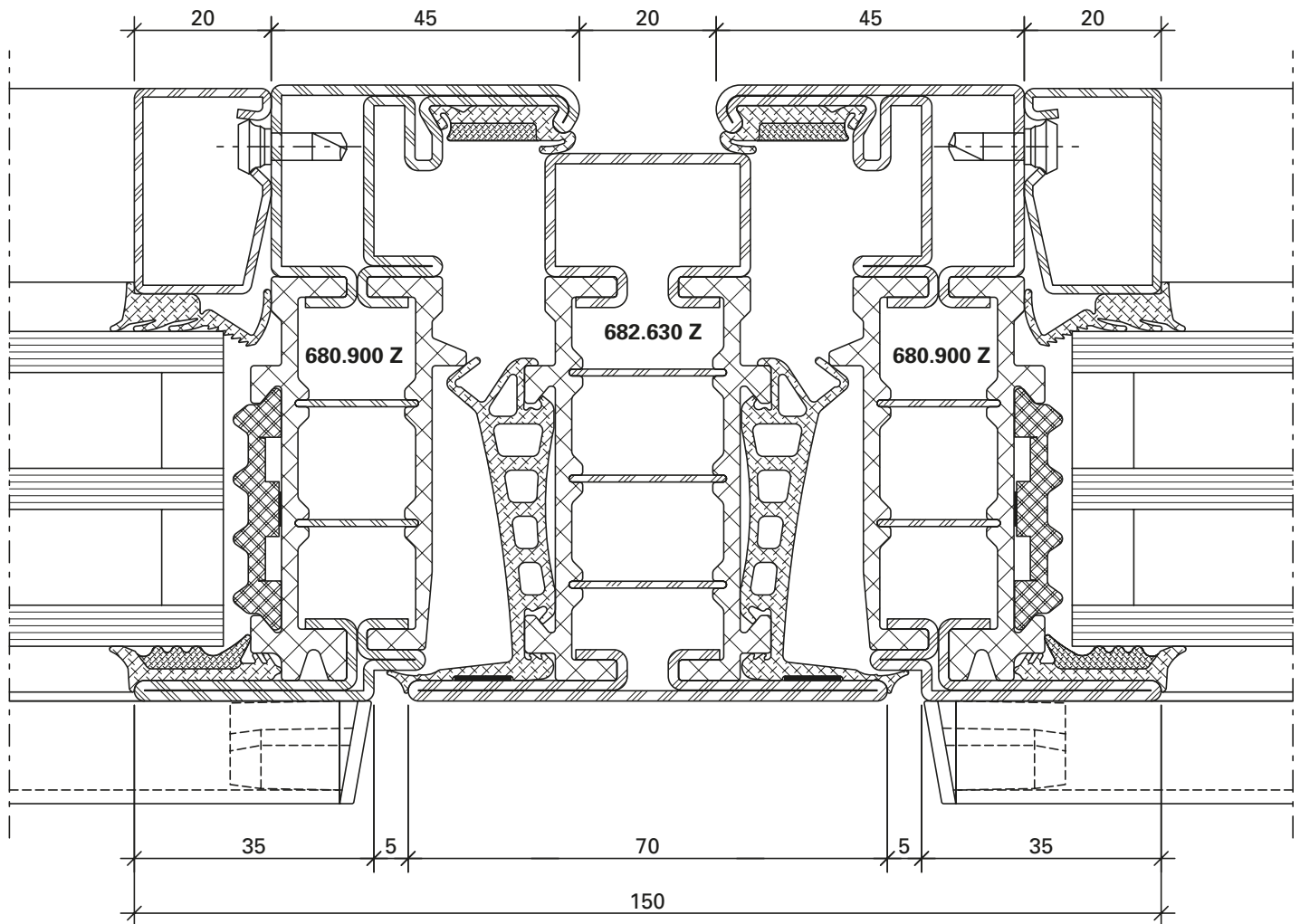

DXF DWG 12-0201-C-006

13.0

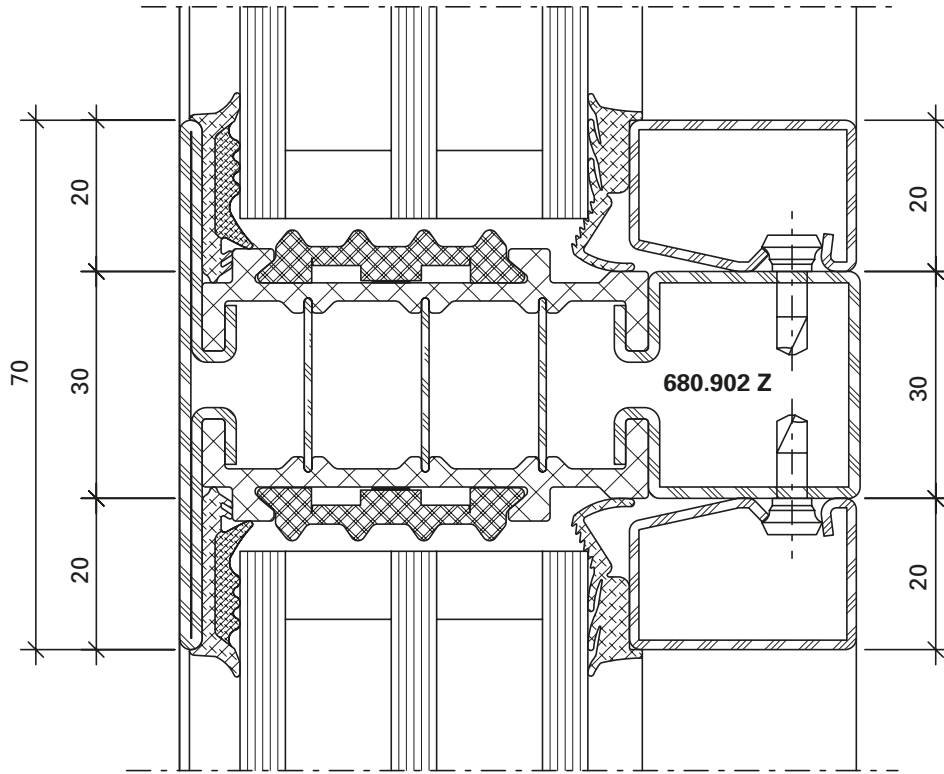

12-0201-C-020

DWG

DXF

5.0

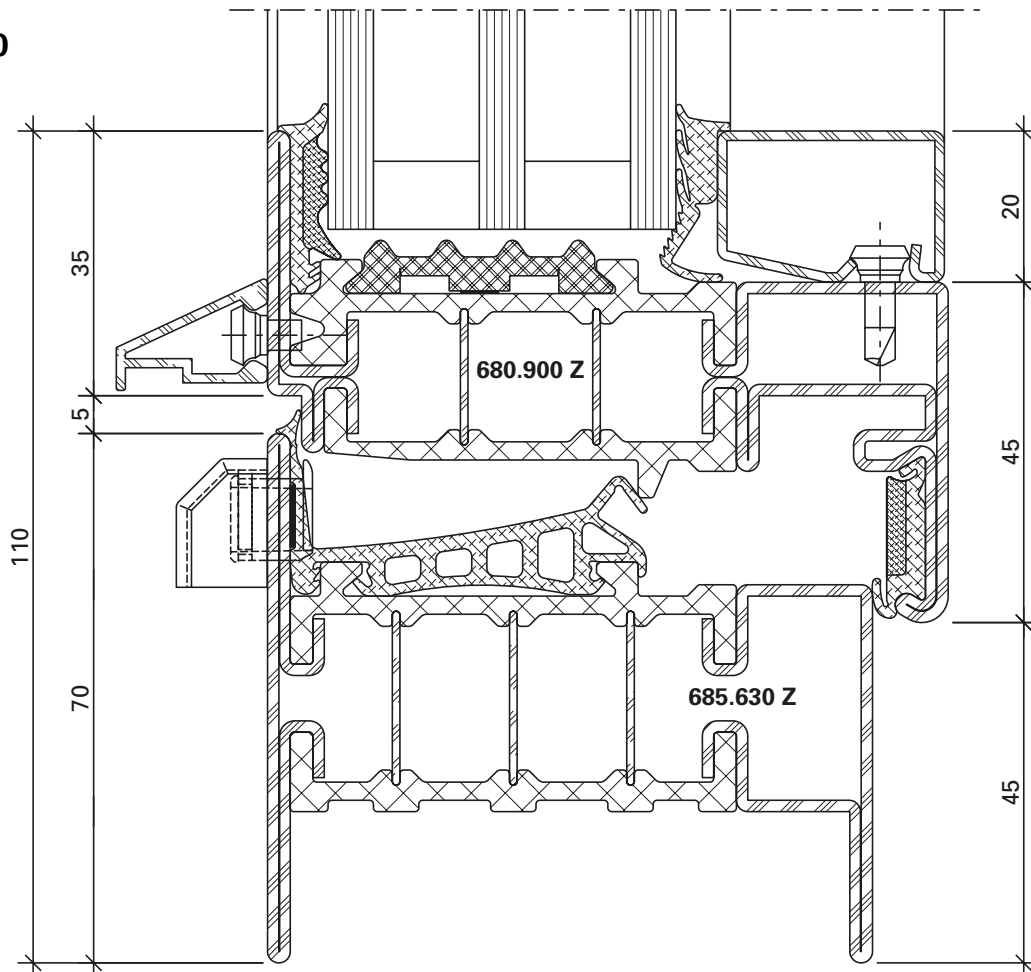

12-0201-C-009

DWG

DXF

6.0

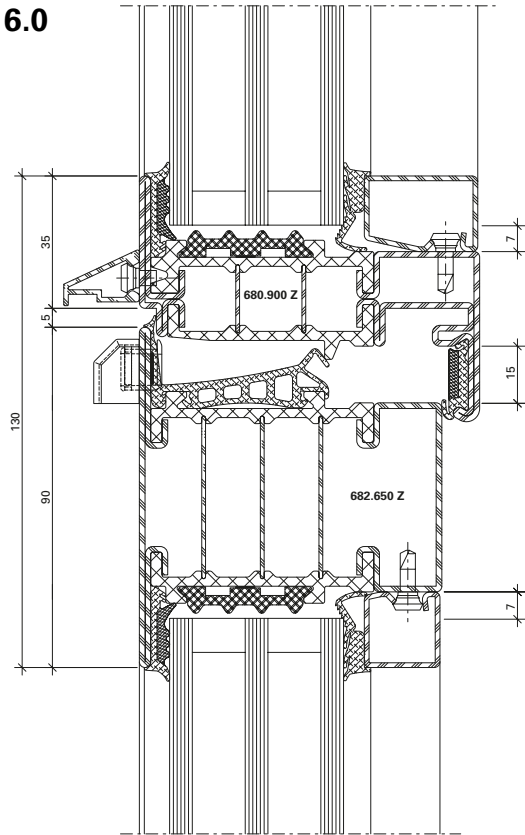

DWG 12-0201-C-016

DWG

DXF

6.1

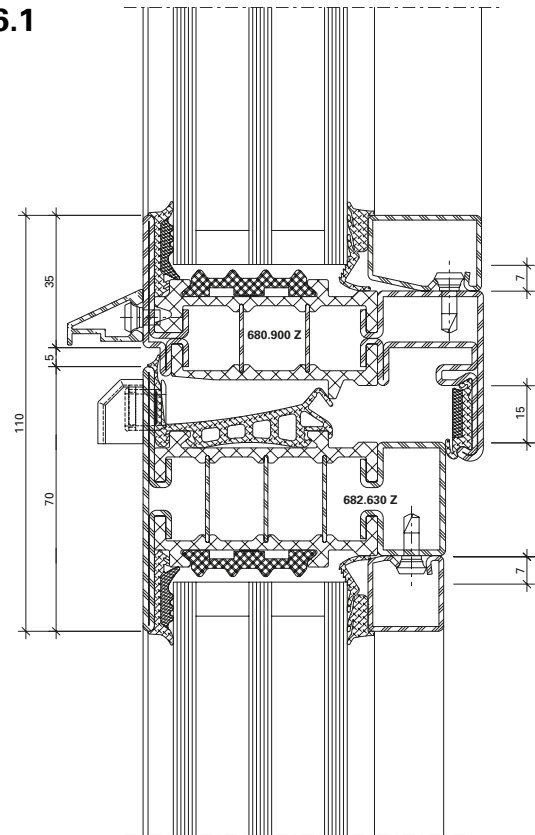

DWG 12-0201-C-019

DWG

DXF

7.0

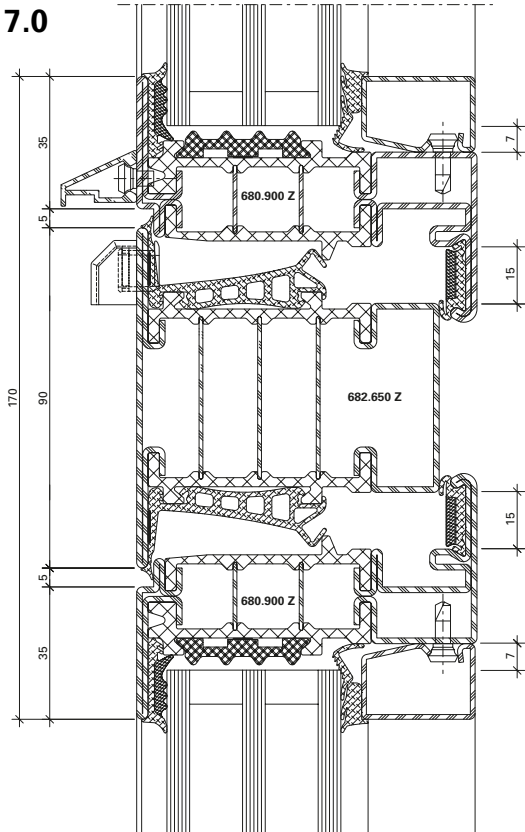

DWG 12-0201-C-018

DWG

DXF

5.1

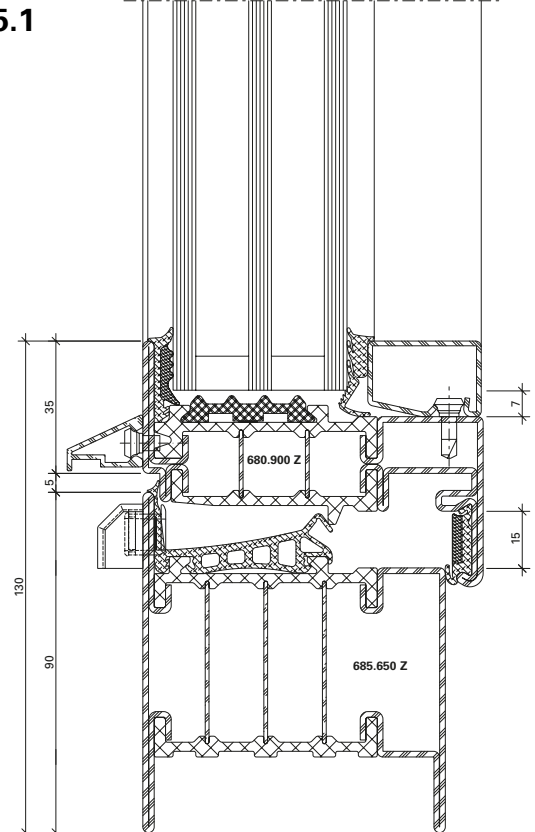

DWG 12-0201-C-008

DWG

DXF

8.0

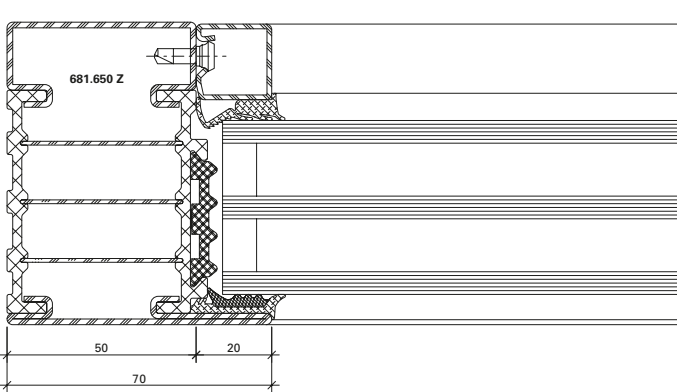

DXF

DWG

12-0201-C-012

9.0

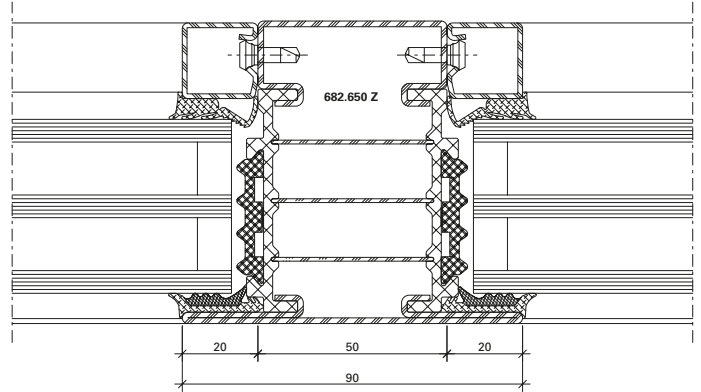

DXF

DWG

12-0201-C-014

8.1

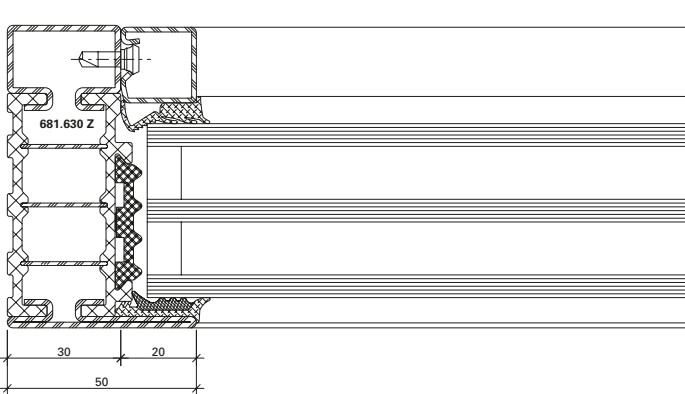

DXF

DWG

12-0201-C-013

9.1

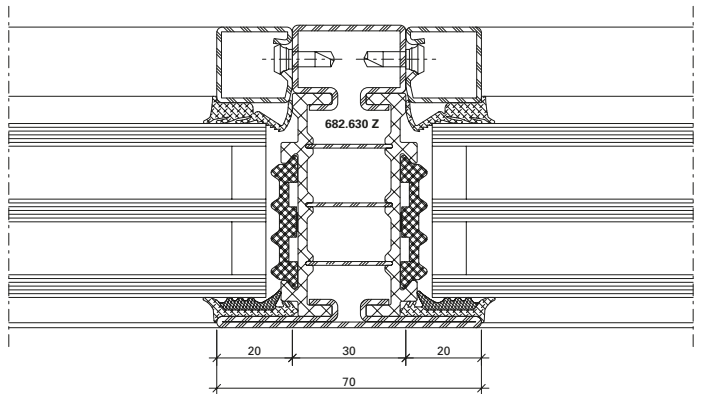

DXF

DWG

12-0201-C-015

10.0

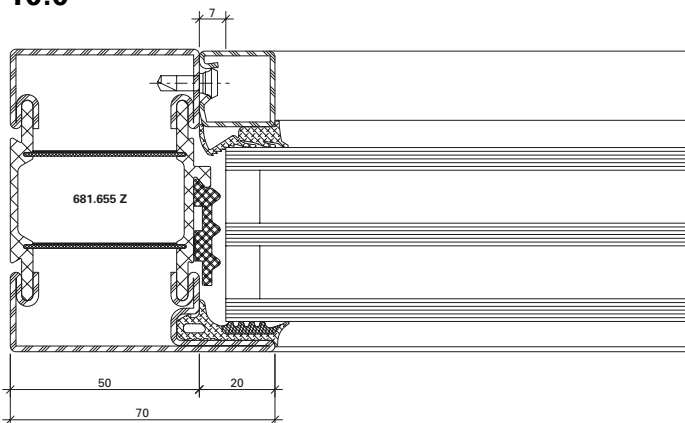

DXF

DWG

12-0204-C-003

10.1

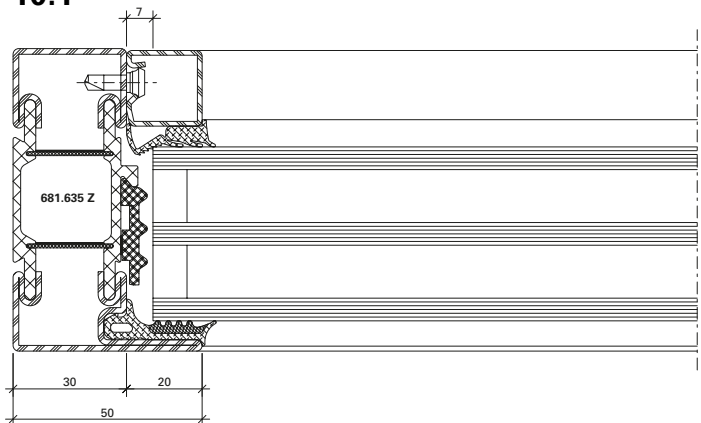

DXF

DWG

12-0204-C-004

3.1

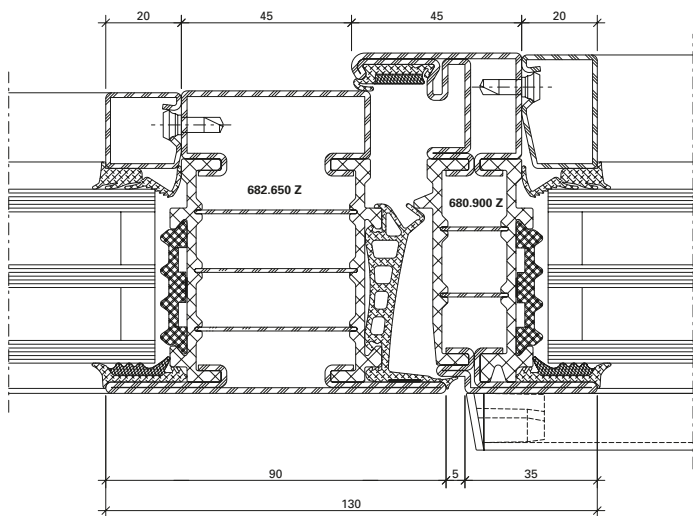

DXF **DWG** 12-0201-C-003

4.1

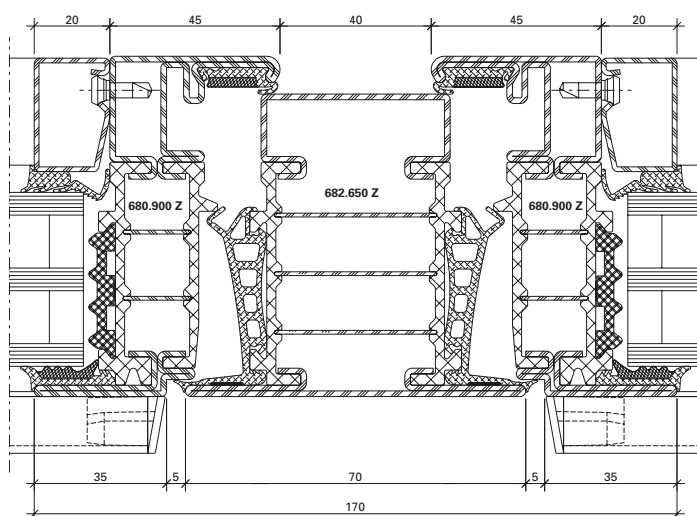

DXF **DWG** 12-0201-C-005

1.3

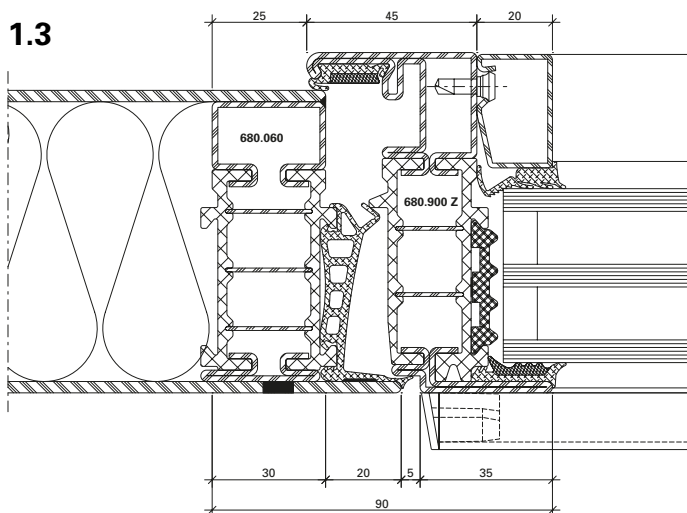

DXF **DWG** 12-0201-C-021

8.2

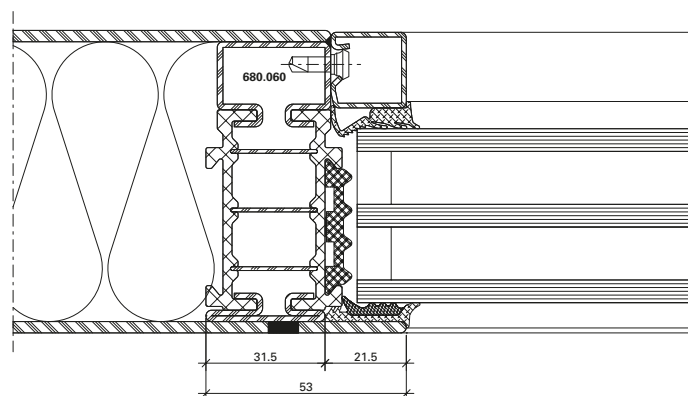

DXF **DWG** 12-0201-C-022

9.2

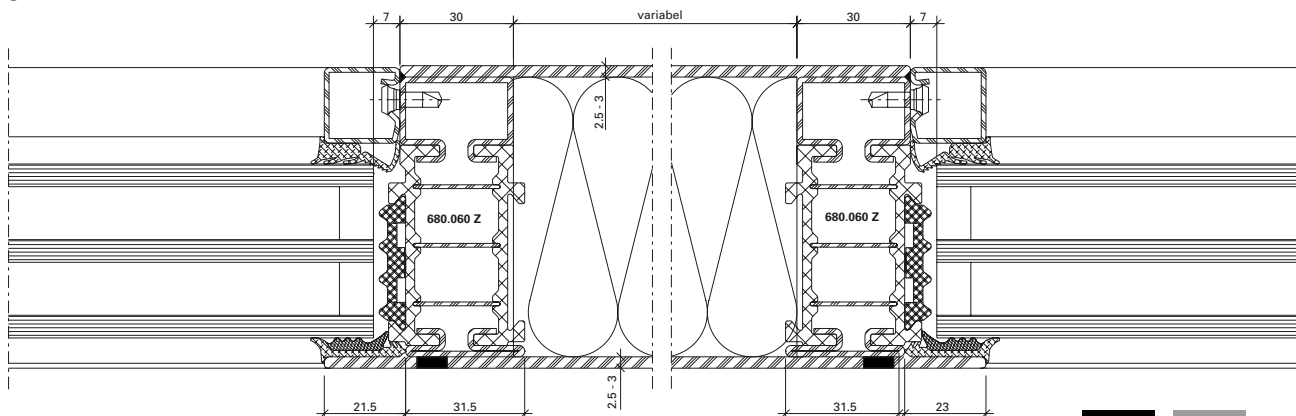

DXF **DWG** 12-0102-C-065

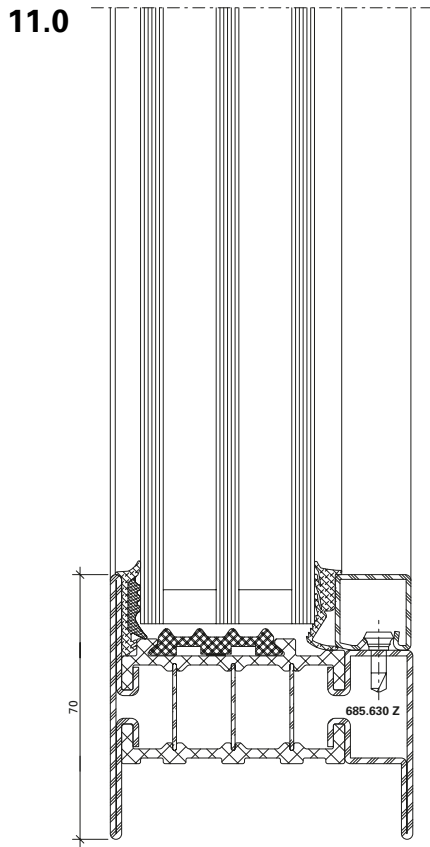

12-0201-C-011

DWG

DXF

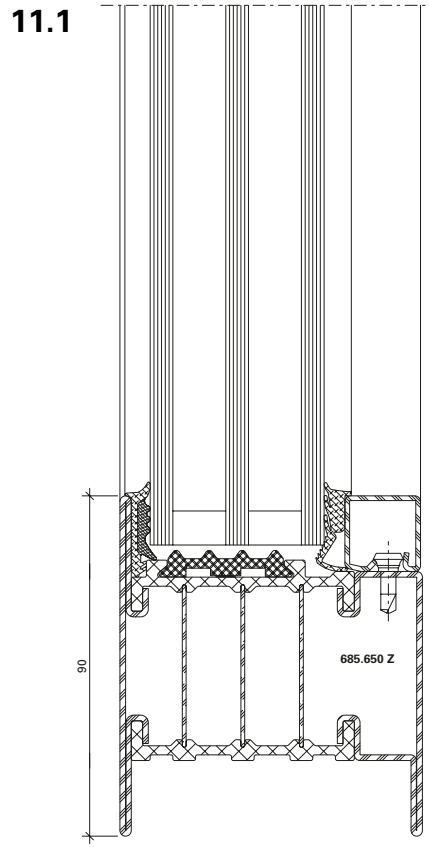

12-0201-C-010

DWG

DXF

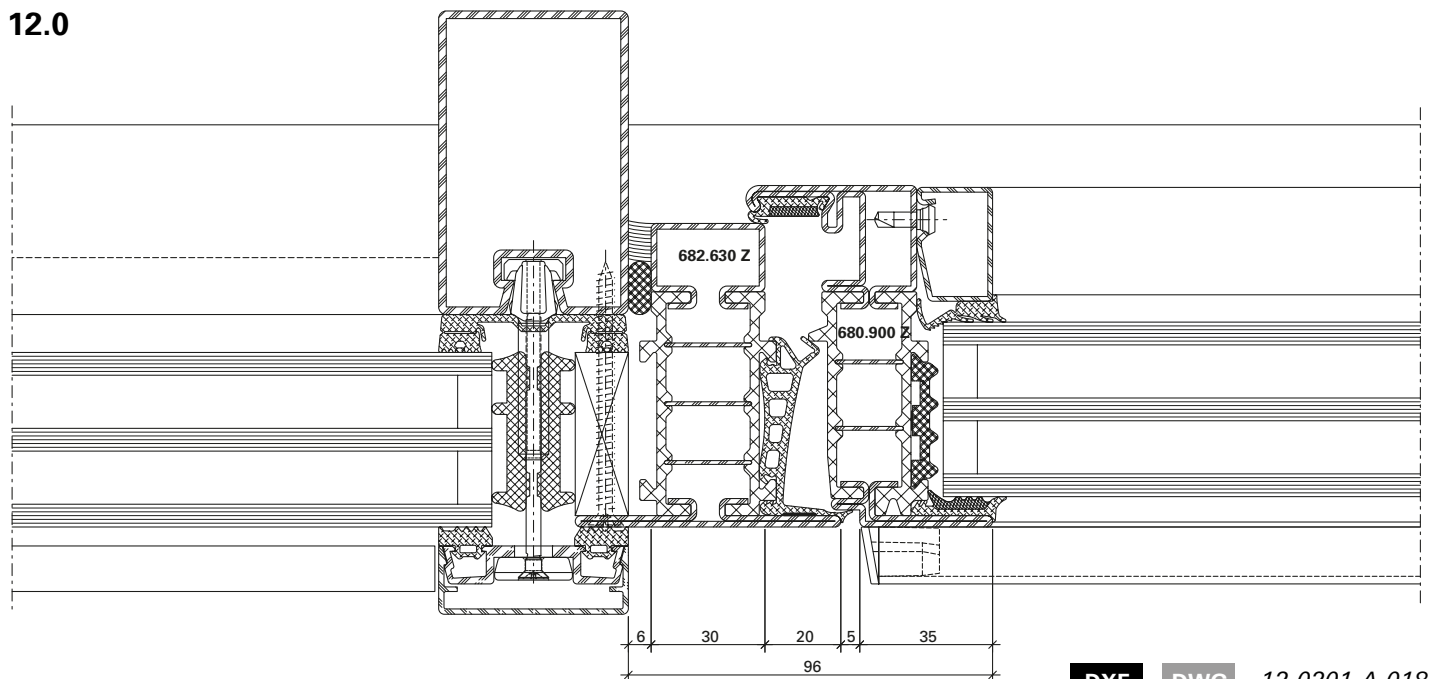

DXF

DWG

12-0201-A-018

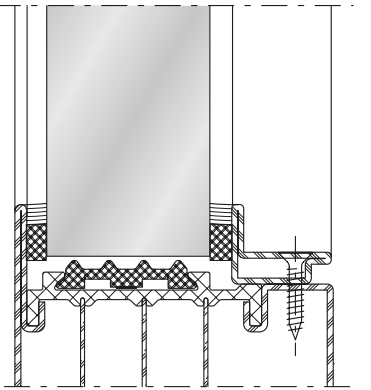
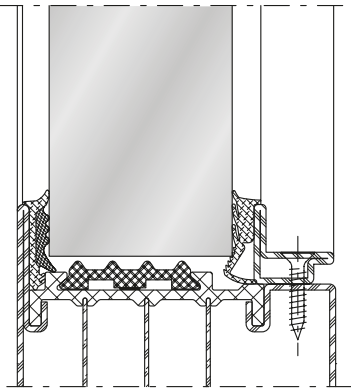
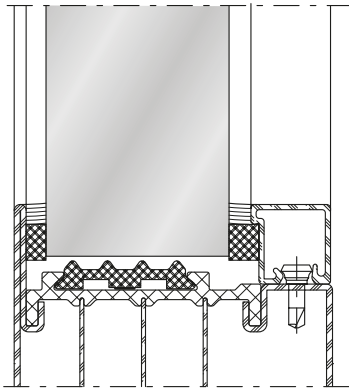
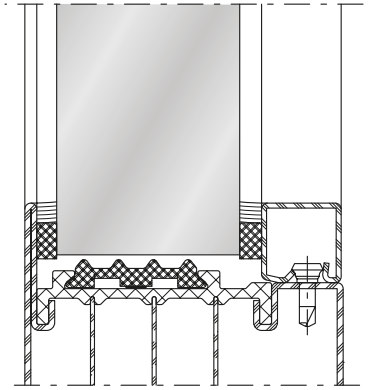
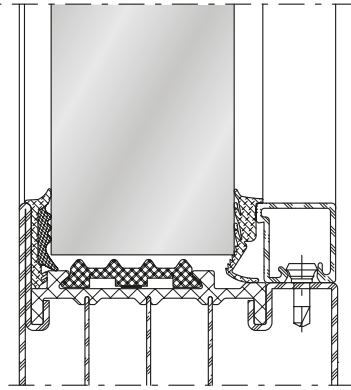
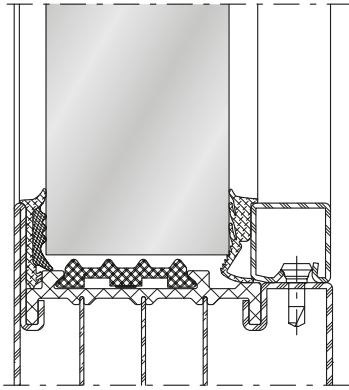

Platzbedarf
Standard-Fensterbeschlag
Bei Öffnungswinkel 90°

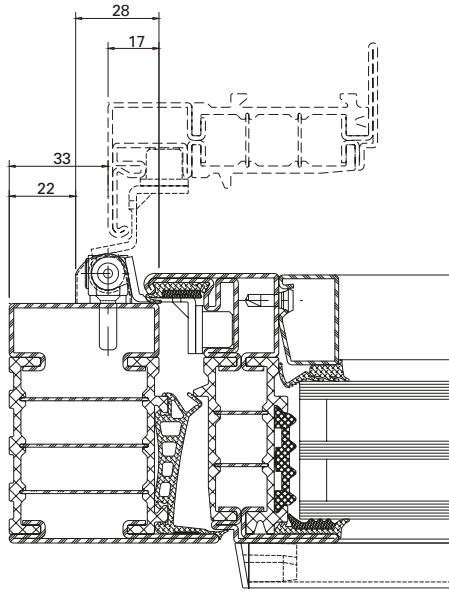

Espace nécessaire
Ferrure de fenêtre standard
À l'angle d'ouverture 90°

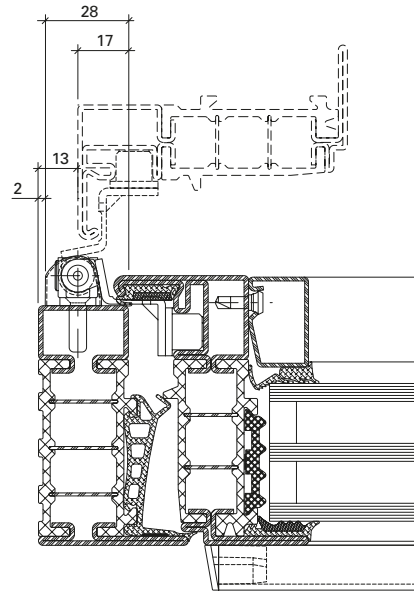

Space required
Standard window fitting
At opening angle 90°

Platzbedarf
Verdeckt liegender Fensterbeschlag
Bei Öffnungswinkel 90°

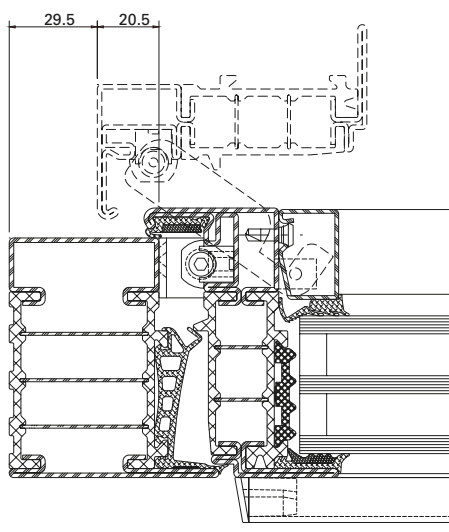

Espace nécessaire
Ferrure de fenêtre non apparente
À l'angle d'ouverture 90°

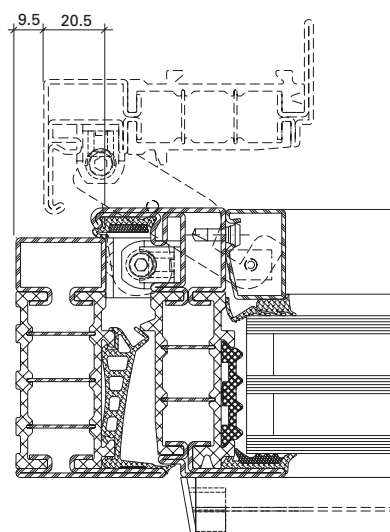

Space required
Concealed window fitting
At opening angle 90°

Platzbedarf
Standard-Fensterbeschlag
Bei Öffnungswinkel 90°

Espace nécessaire
Ferrure de fenêtre standard
À l'angle d'ouverture 90°

Space required
Standard window fitting
At opening angle 90°

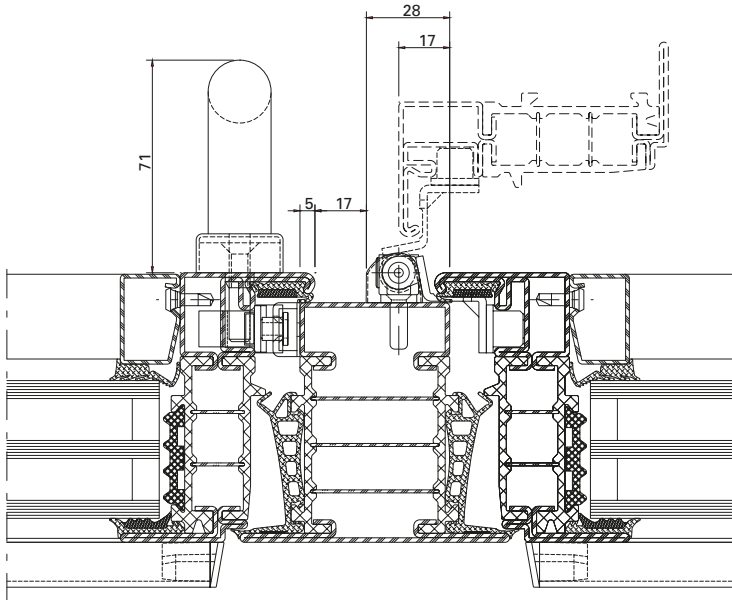

Platzbedarf
Verdeckt liegender Fensterbeschlag
Bei Öffnungswinkel 90°

Espace nécessaire
Ferrure de fenêtre non apparente
À l'angle d'ouverture 90°

Space required
Concealed window fitting
At opening angle 90°

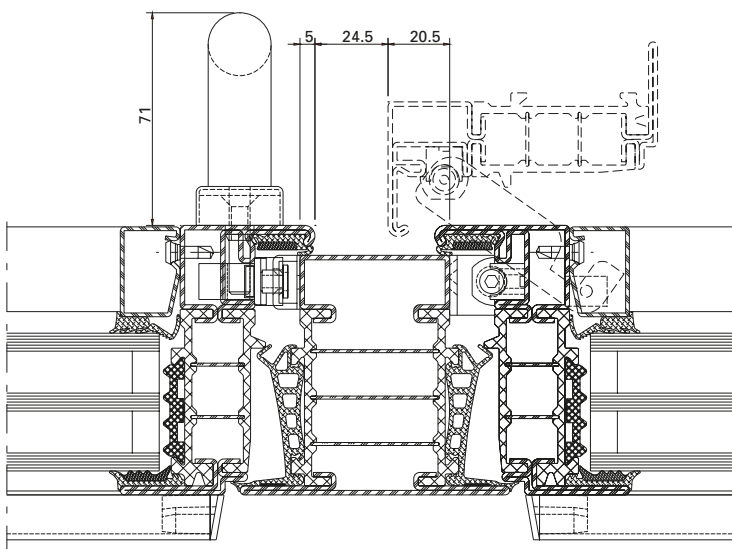

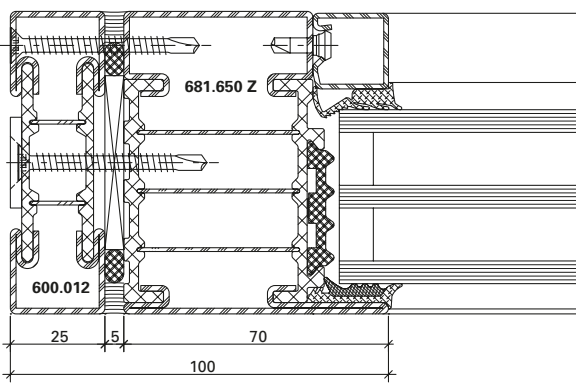

DXF **DWG** 12-0201-K-001

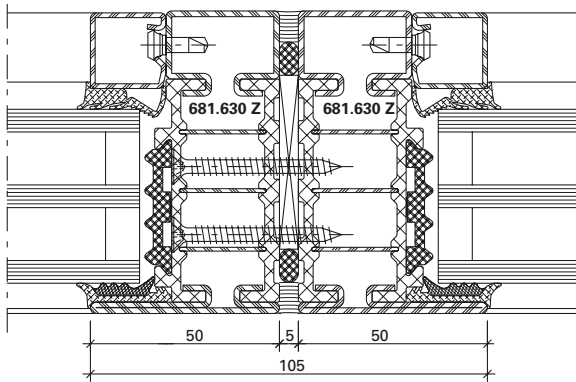

DXF **DWG** 12-0201-K-002

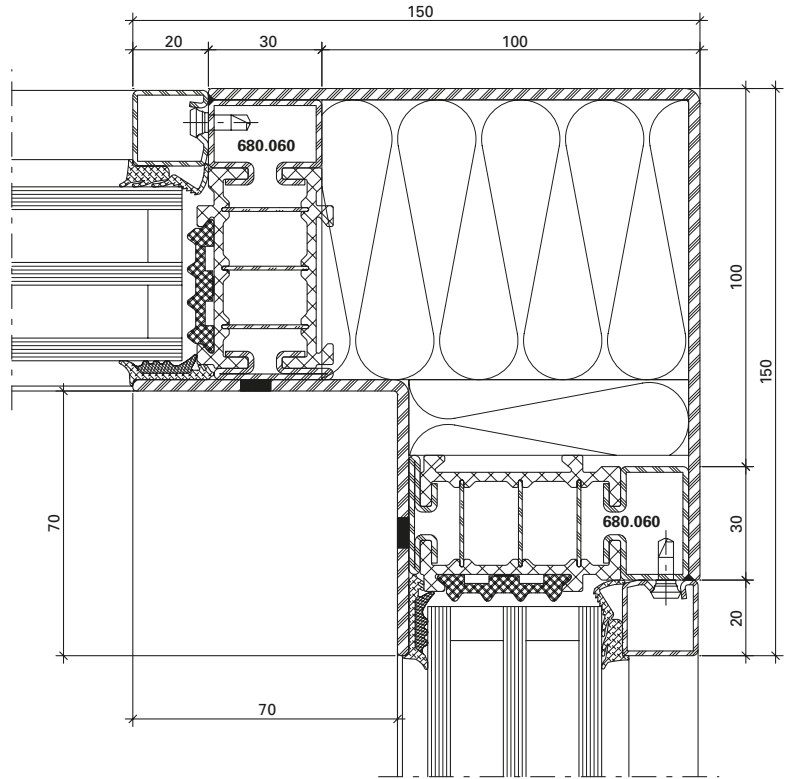

DXF **DWG** 12-0201-K-005

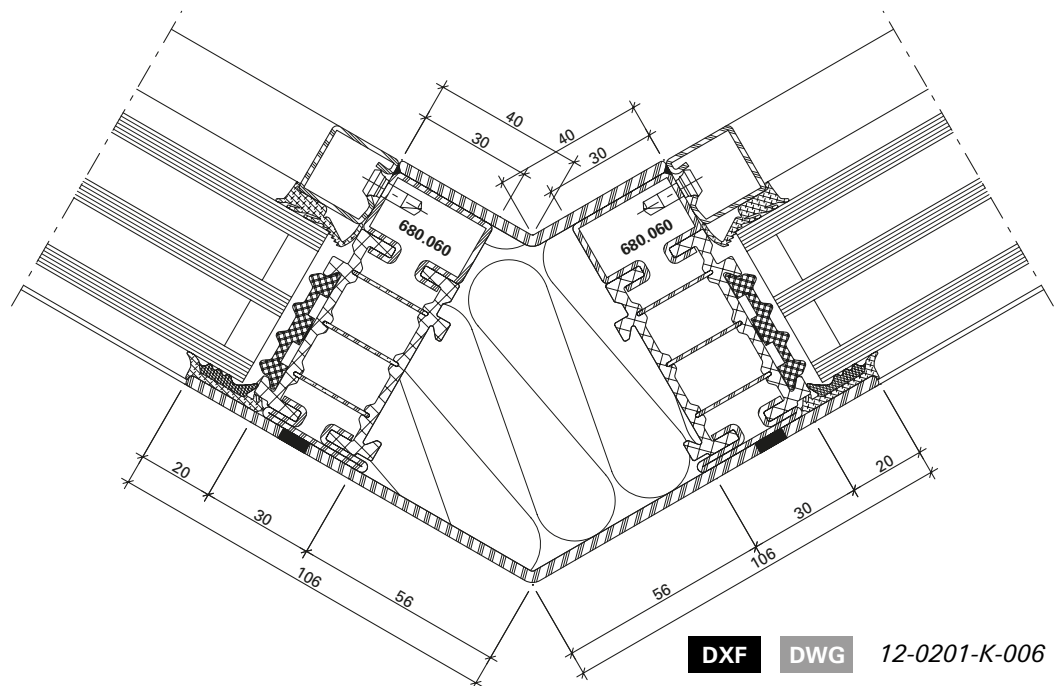

DXF **DWG** 12-0201-K-006

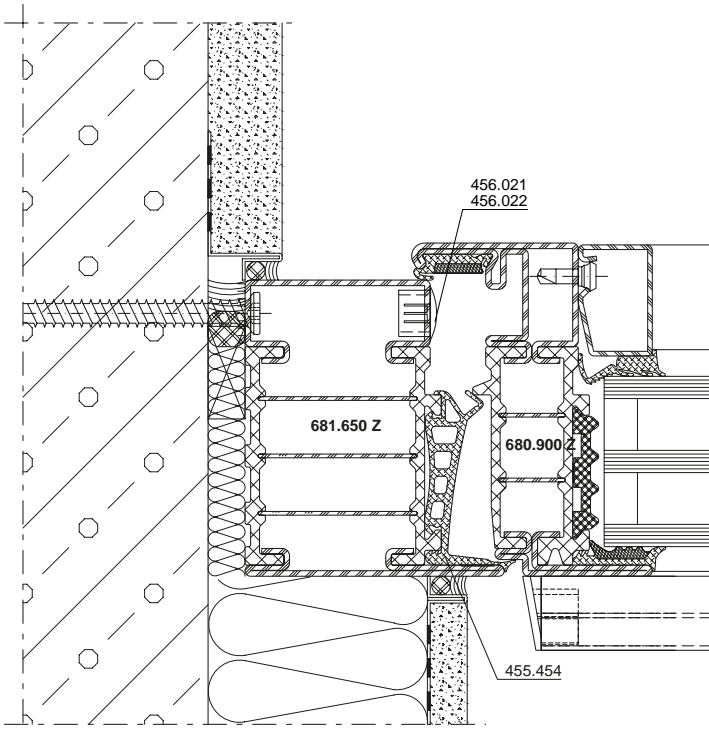

DXF **DWG** 12-0201-A-037

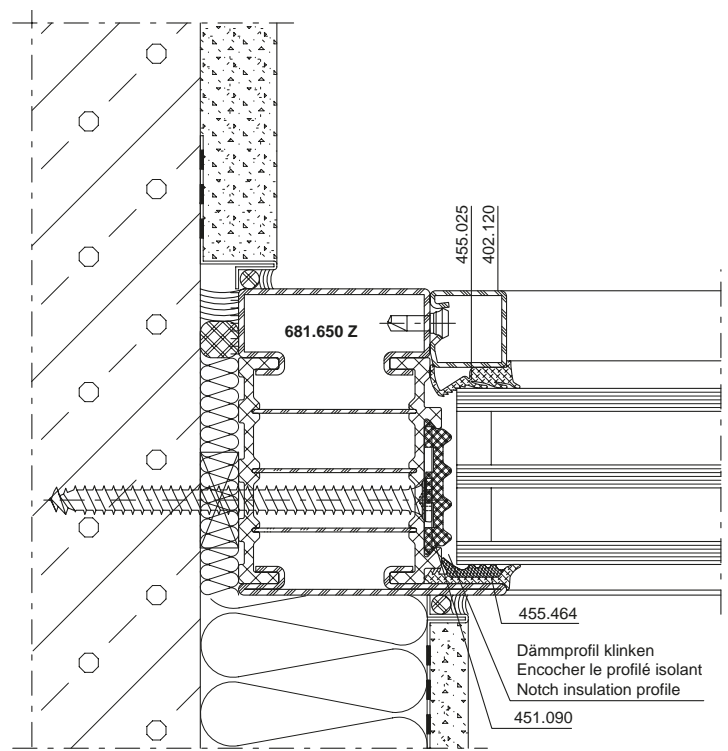

DXF **DWG** 12-0201-A-038

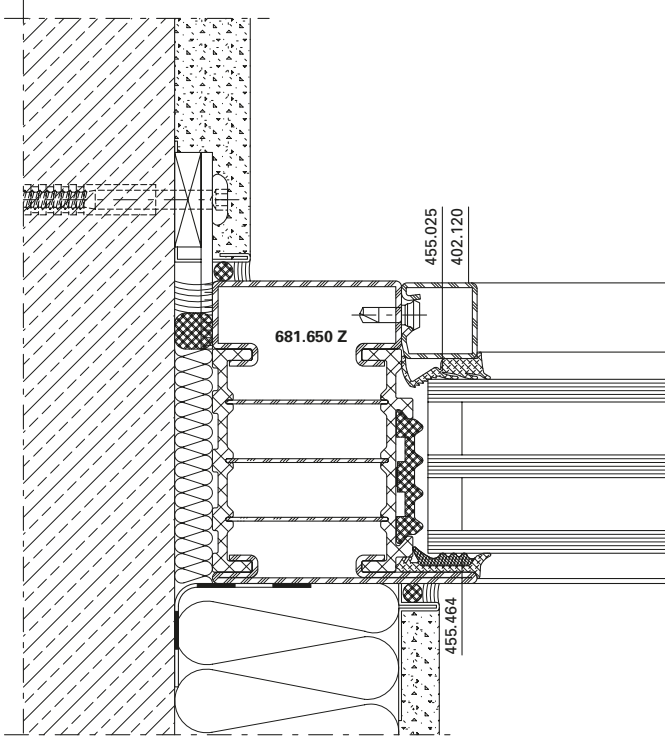

DXF **DWG** 12-0201-A-002

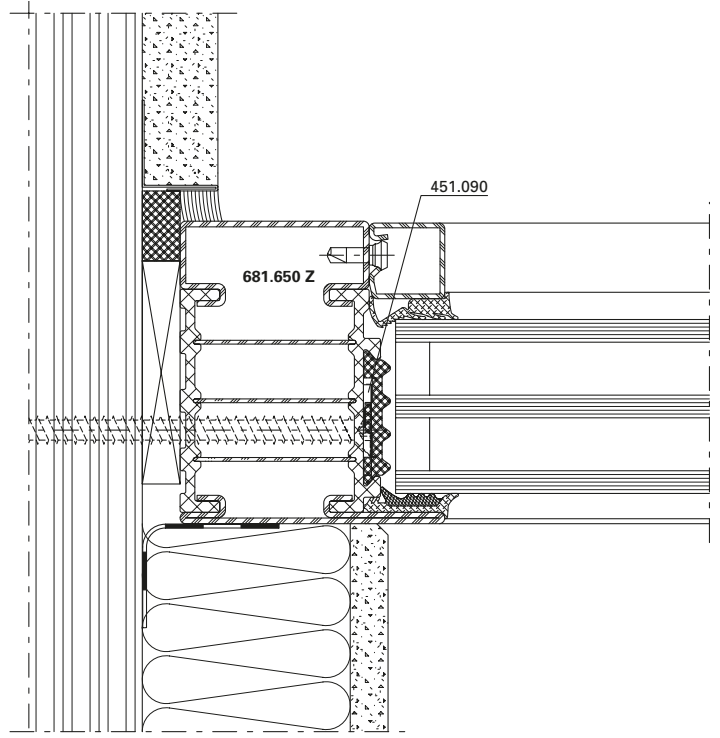

DXF **DWG** 12-0201-A-016

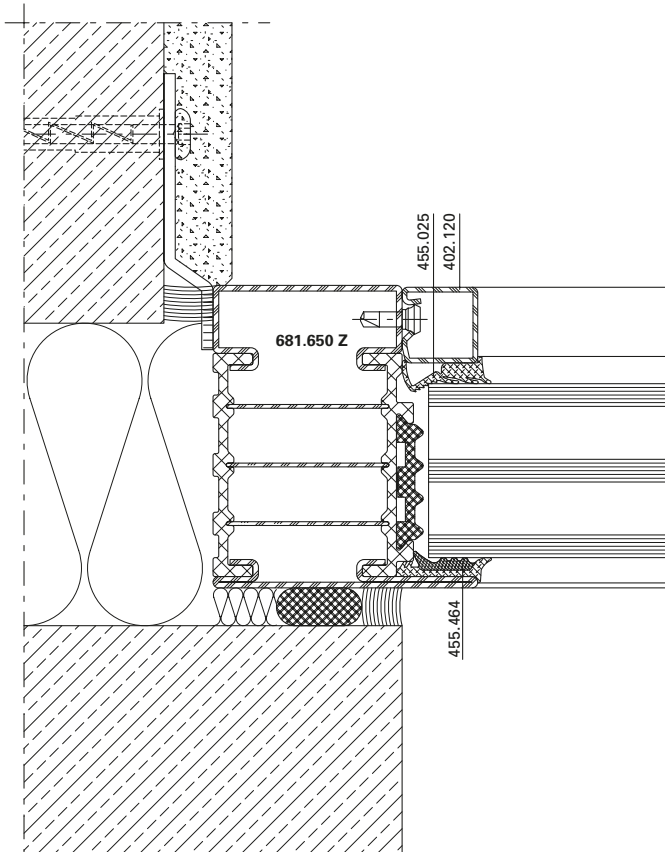

DXF **DWG** 12-0201-A-004

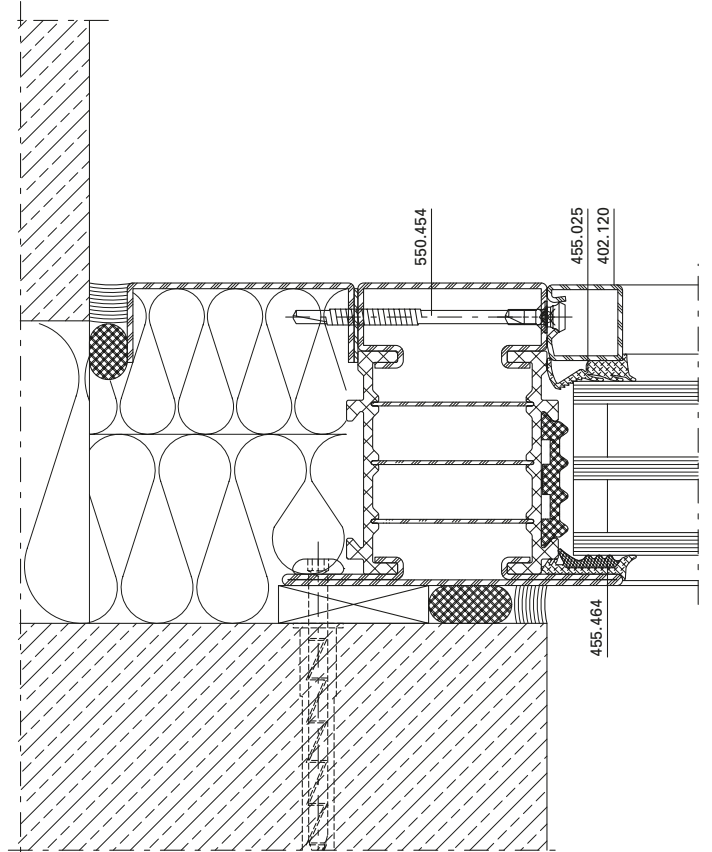

DXF **DWG** 12-0201-A-005

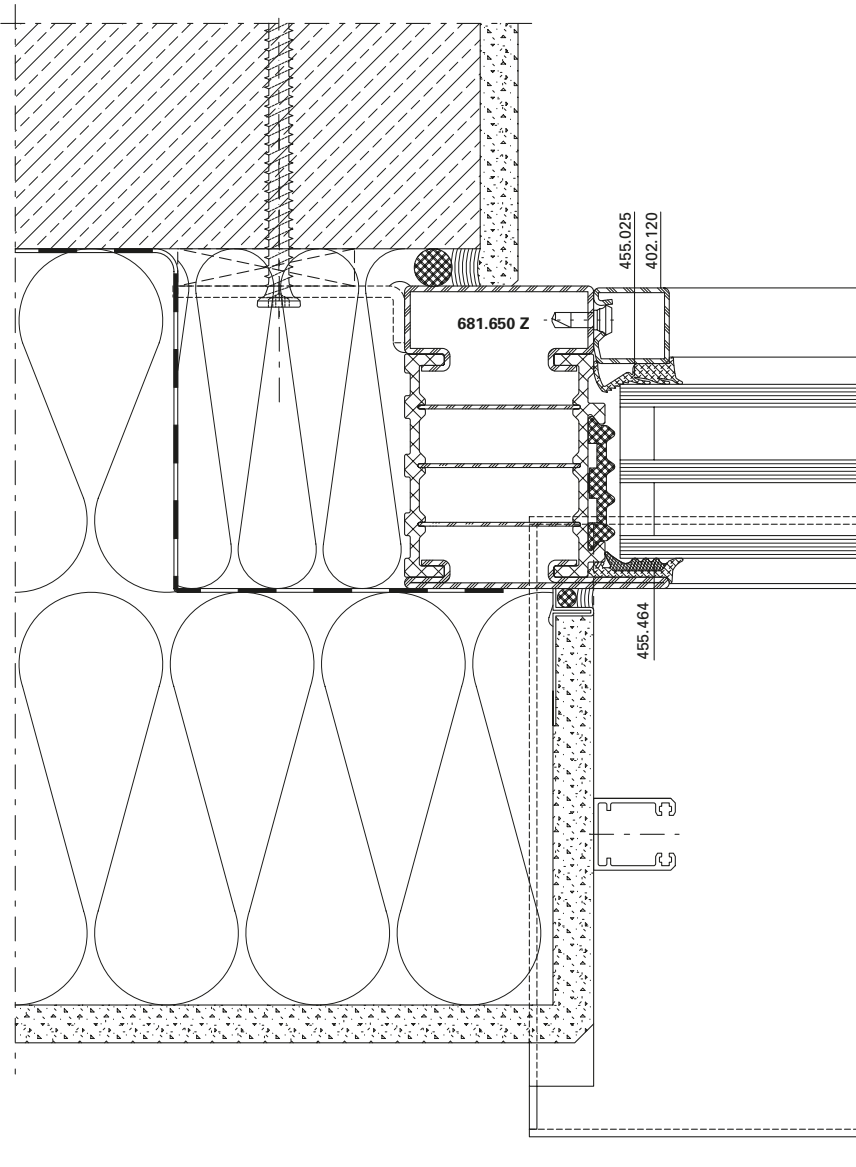

DXF **DWG** 12-0201-A-001

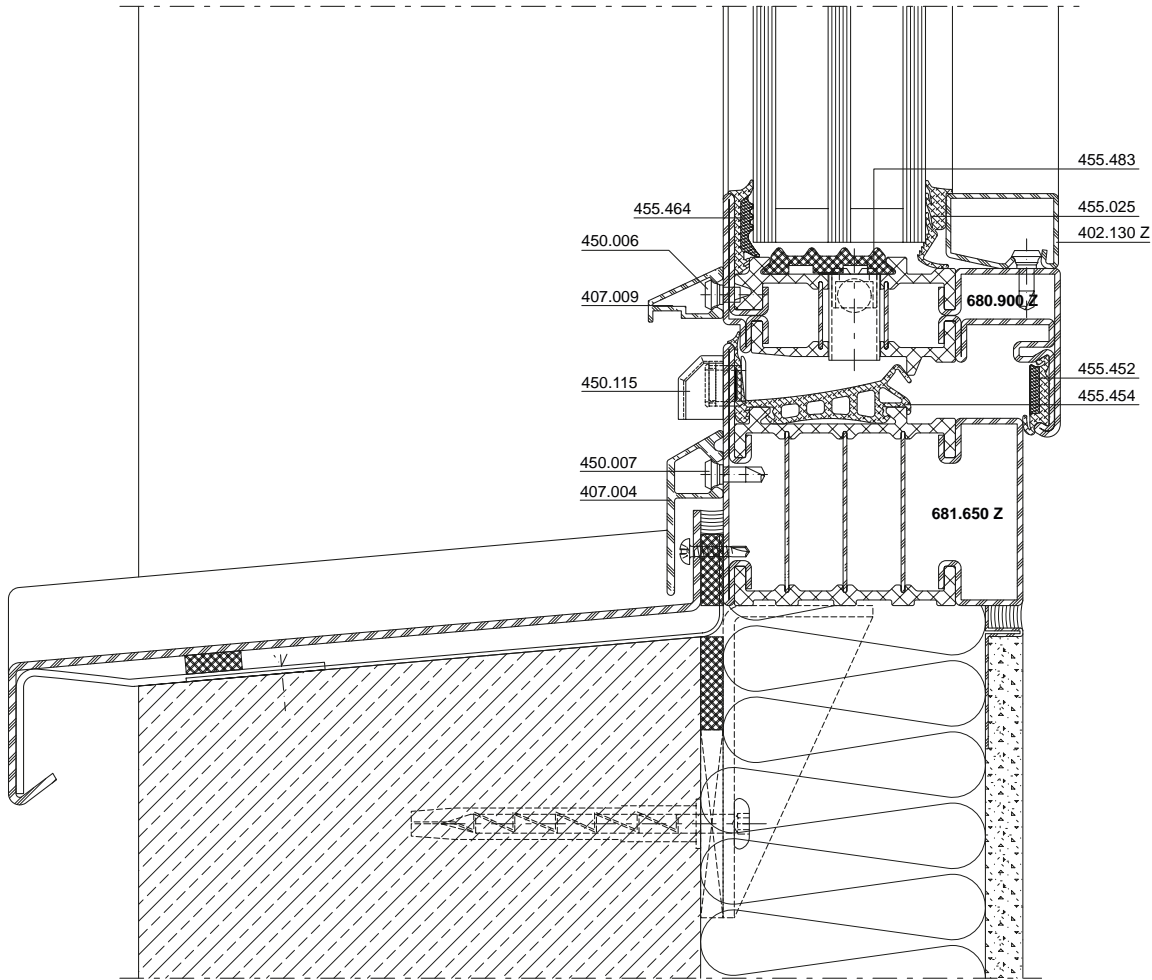

DXF

DWG

12-0201-A-014

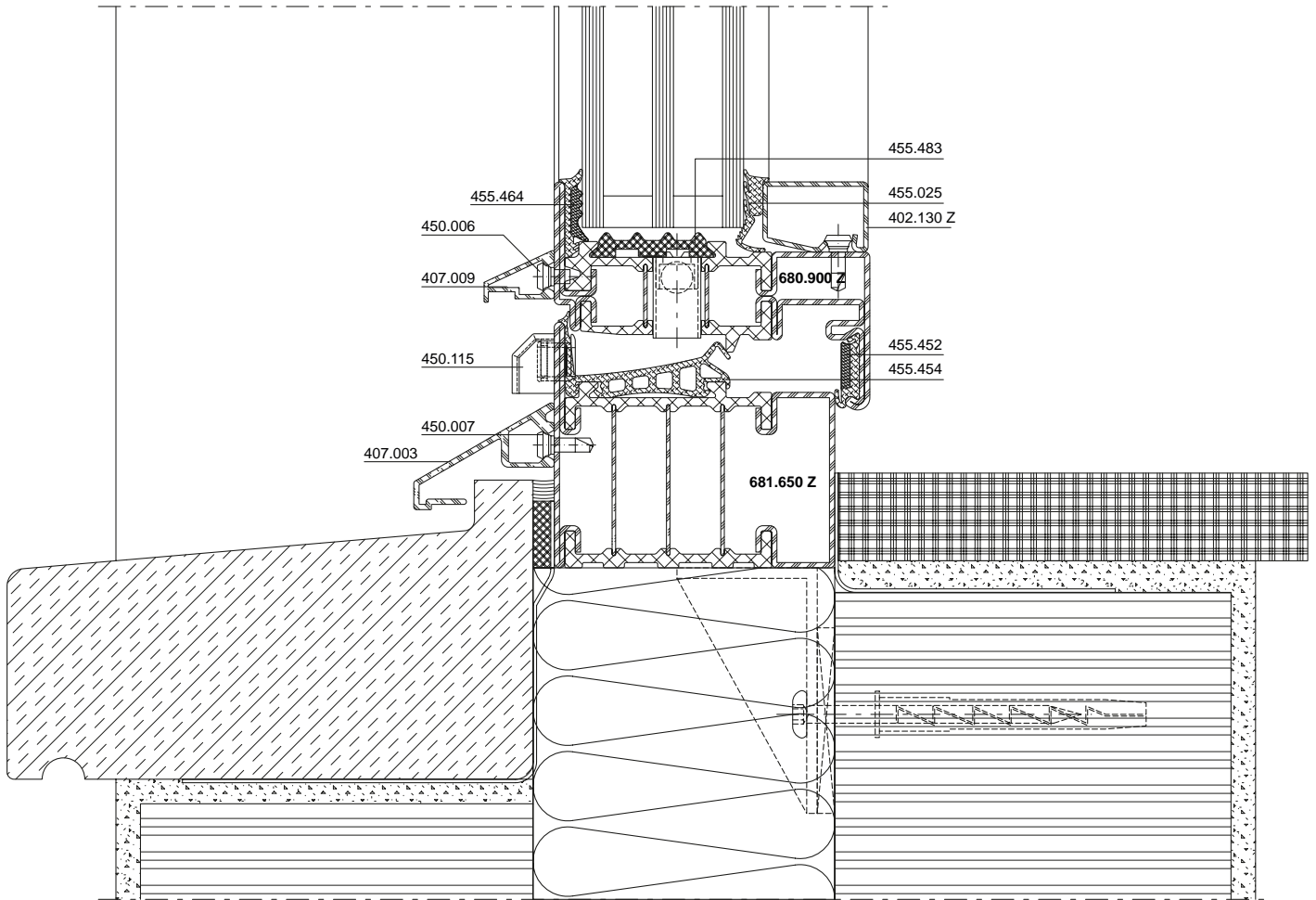

DXF

DWG

12-0201-A-012

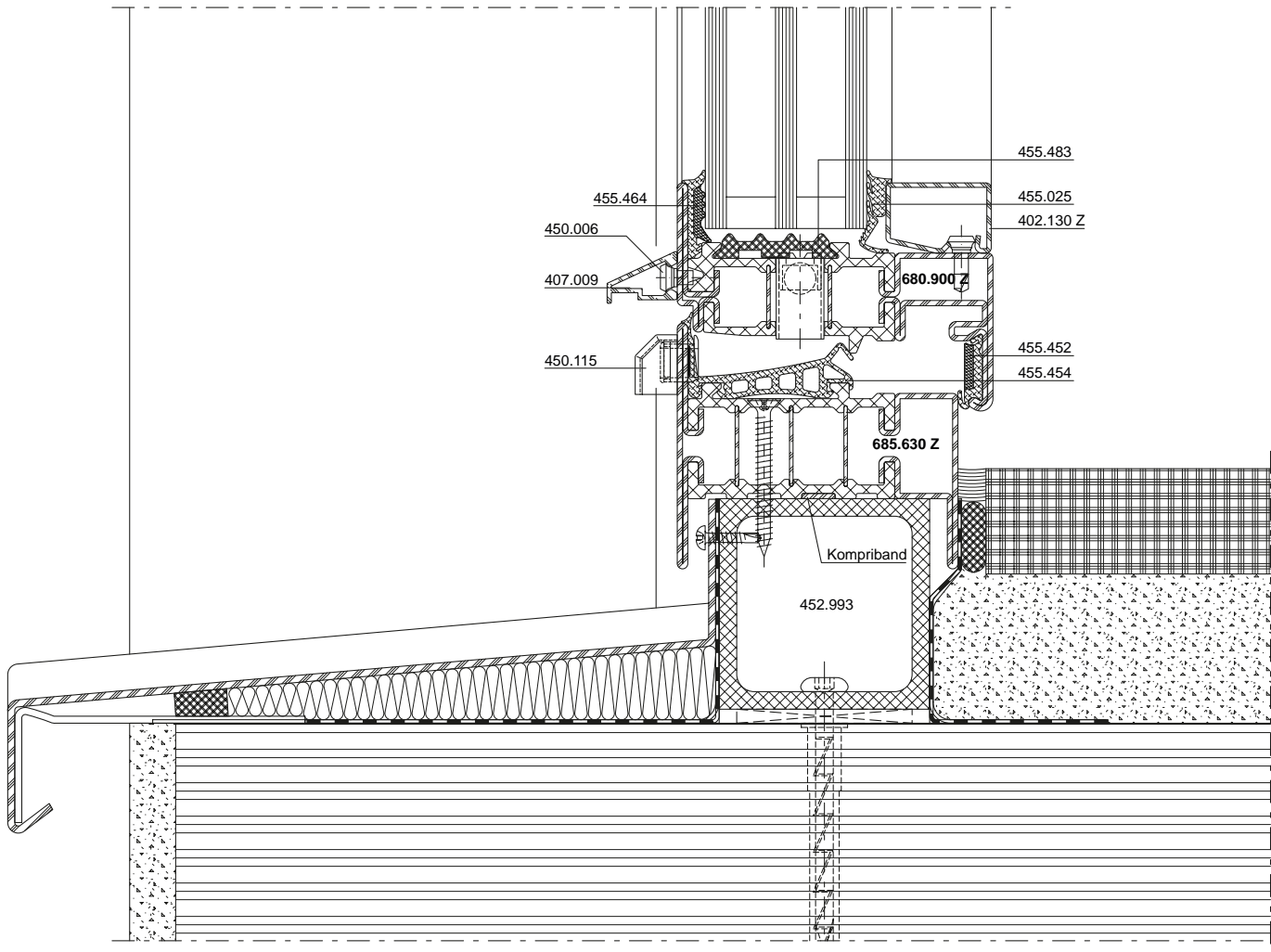

DXF DWG 12-0201-A-015

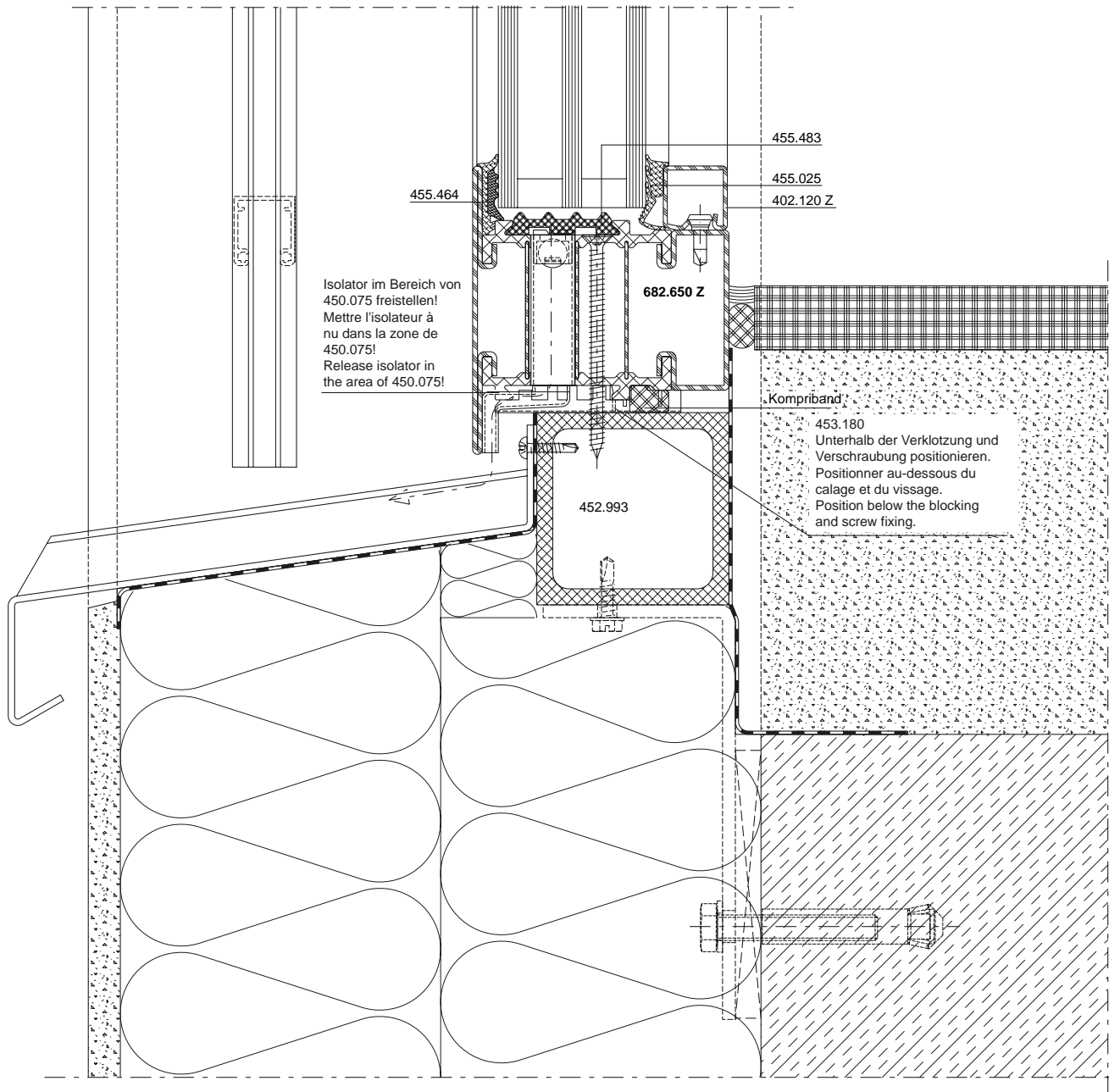

DXF

DWG

12-0201-A-006

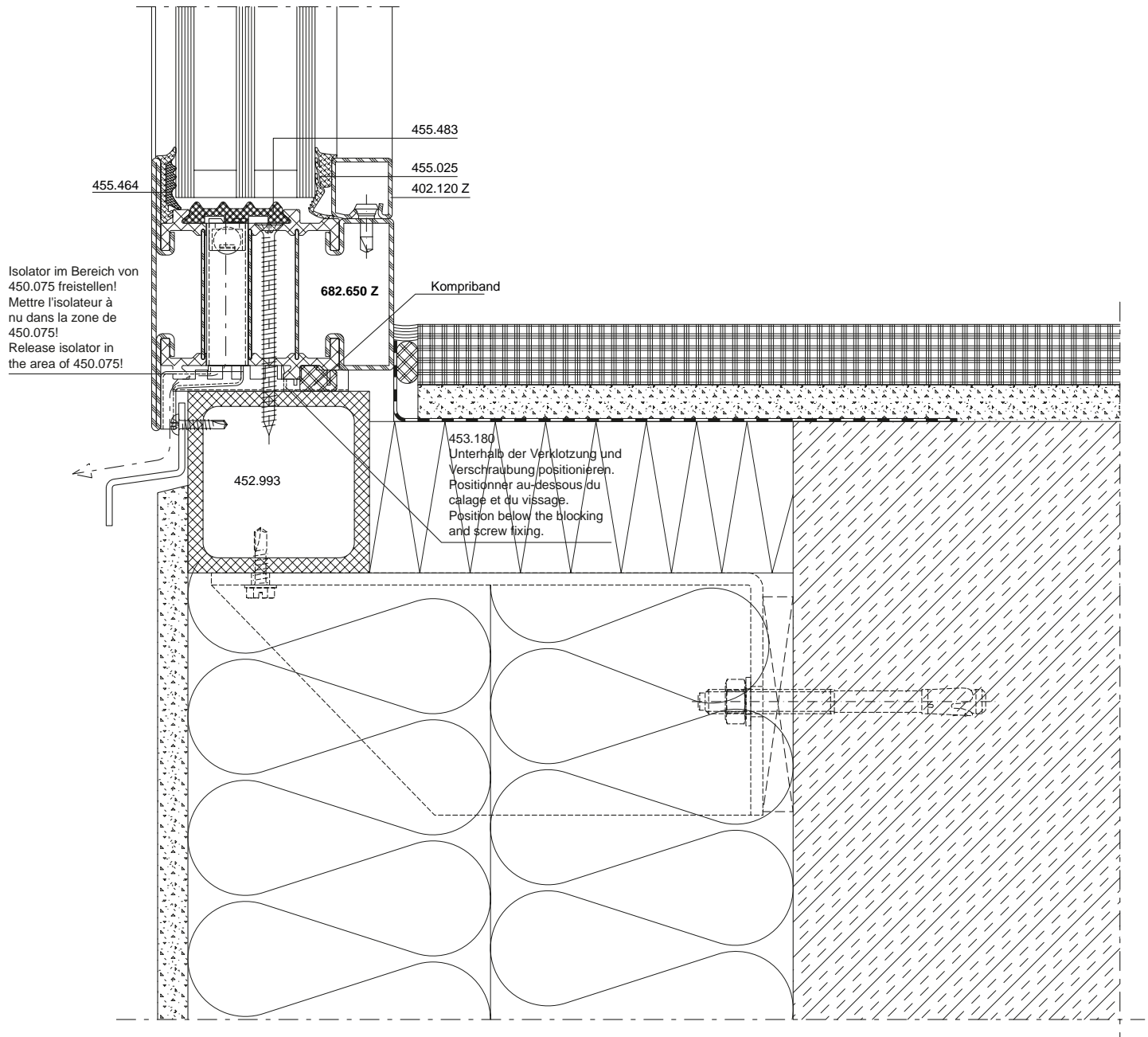

DXF

DWG

12-0201-A-008

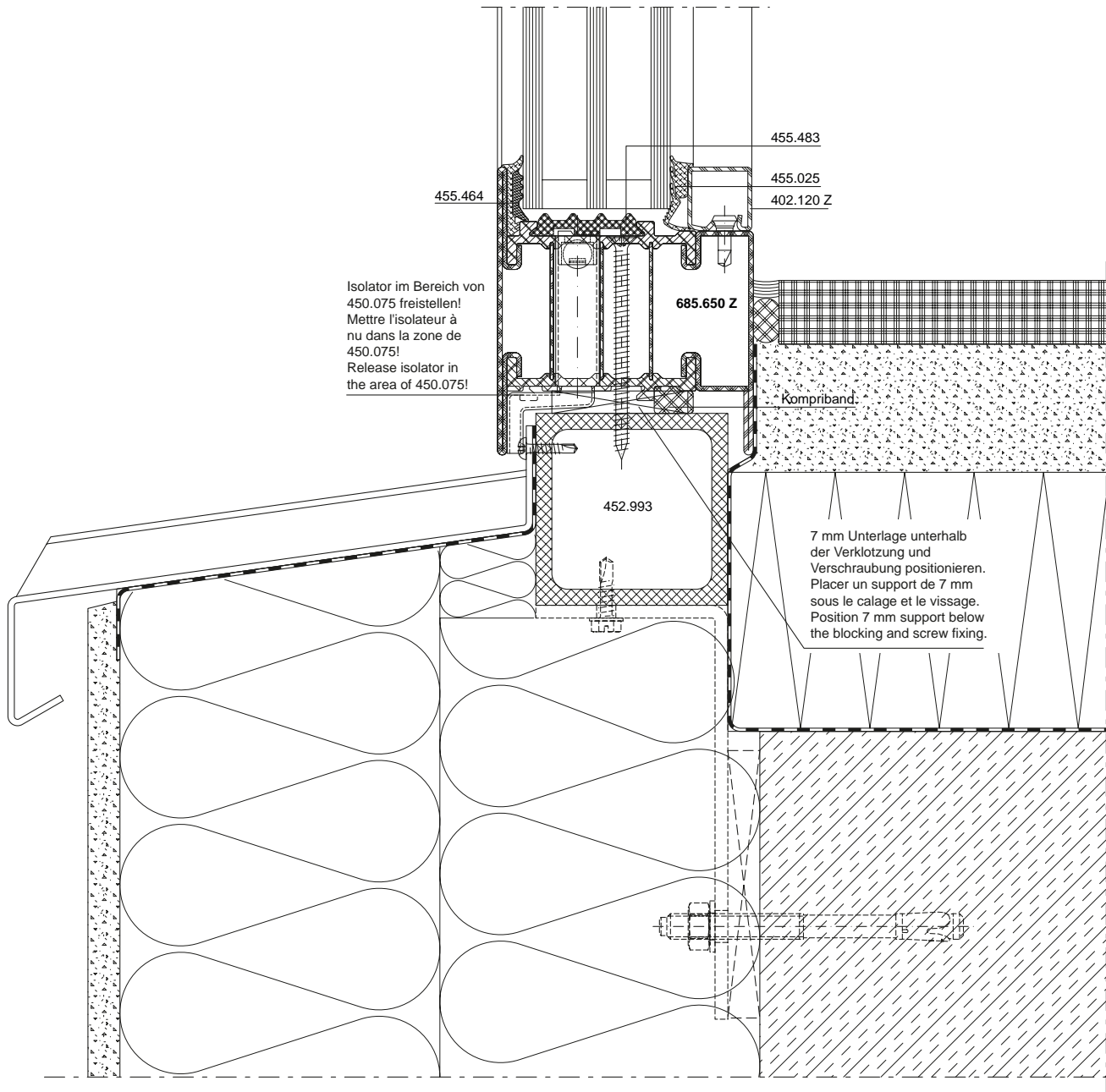

DXF

DWG

12-0201-A-009

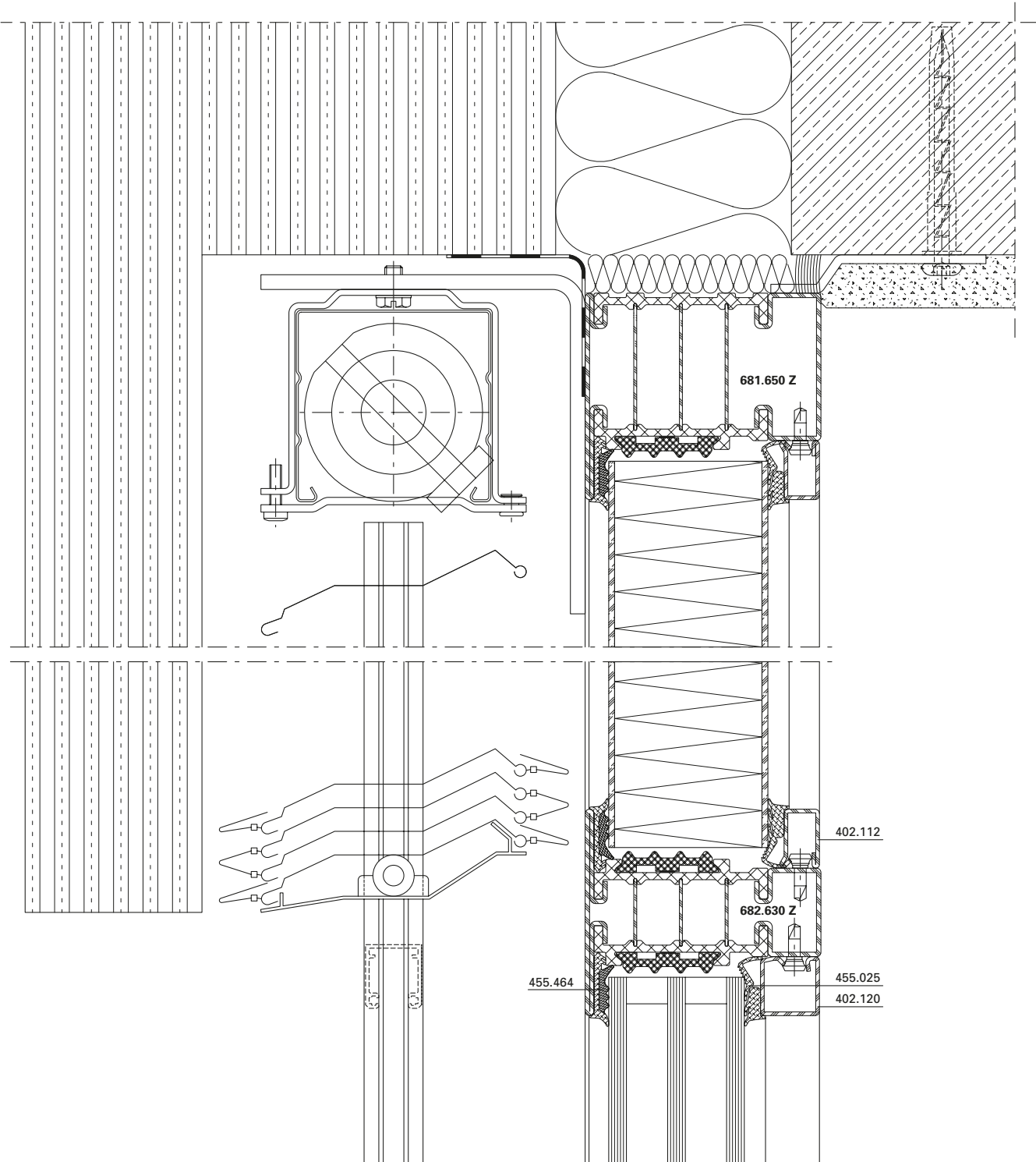

DXF

DWG

12-0201-A-010

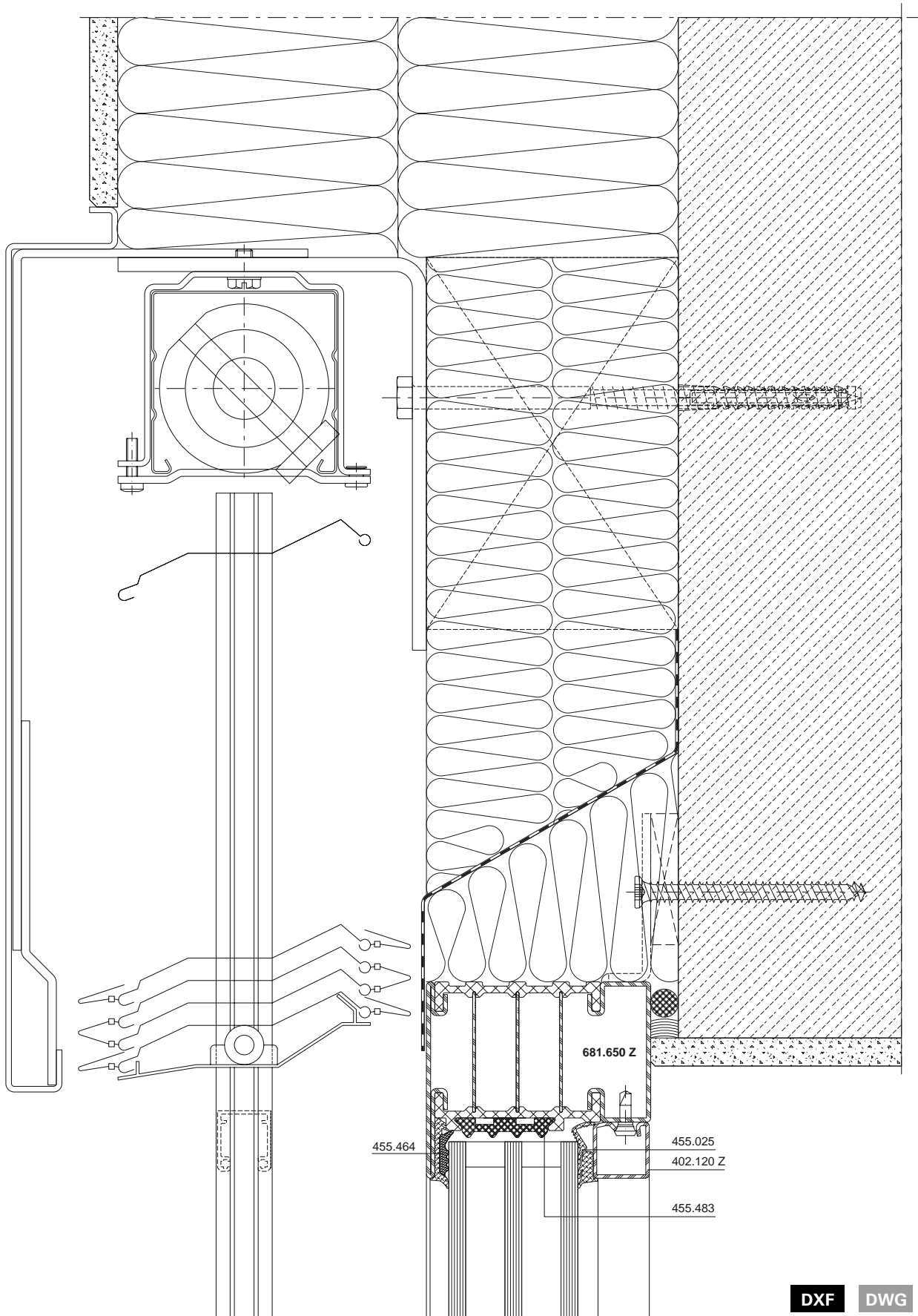

Leistungswerte
 Fenster aus Stahl

Caractéristiques de performances
 Fenêtres en acier

Performance values
 Windows made of steel

Schlagregendichtheit
 Luftdurchlässigkeit
 Widerstand bei Windlast

Étanchéité à la pluie battante
 Perméabilité à l'air
 Résistance à la pression du vent

Watertightness
 Air permeability
 Resistance to wind load

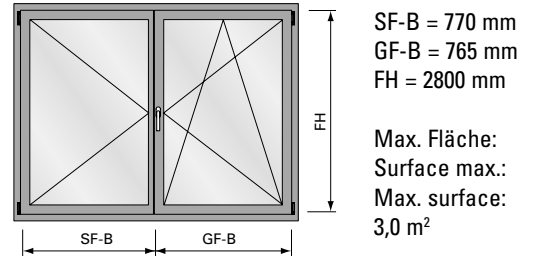
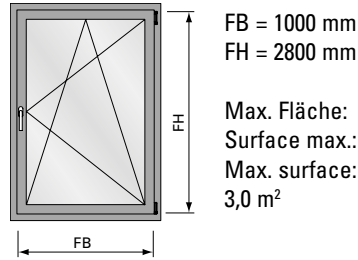

	EN 12208	EN 12207	EN 12210	EN 12208	EN 12207	EN 12210
	Klasse E750 Classe E750 Class E750	Klasse 4 Classe 4 Class 4	Klasse C4/B4 Classe C4/B4 Class C4/B4	Klasse 8A Classe 8A Class 8A	Klasse 4 Classe 4 Class 4	Klasse C4/B4 Classe C4/B4 Class C4/B4
Größenänderungen Variations dimensionnelles Size changes	-100%	-100%	-100%	-100%	-100%	-100%

	EN 12208	EN 12207	EN 12210
	Klasse E750 Classe E750 Class E750	Klasse 4 Classe 4 Class 4	Klasse C4/B4 Classe C4/B4 Class C4/B4
Grösse Festverglasung nach objektspezifischer Glasstatik Taille du vitrage fixe selon la statique du verre spécifique à l'objet Size of fixed glazing according to the glass statics of the specific project			

Leistungswerte für Sondergeometrien

Caractéristiques de performances pour géométrie spéciale

Performances values for special geometry

Schlagregendichtheit
 Luftdurchlässigkeit
 Widerstand bei Windlast

Étanchéité à la pluie battante
 Perméabilité à l'air
 Résistance à la pression du vent

Watertightness
 Air permeability
 Resistance to wind load

Atelierfenster
 Fenêtre trapézoïdale
 Studio window

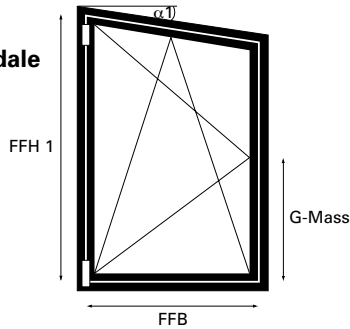

FFB = 1250 mm
 FFH 1 = 2760 mm
 Max. Fläche:
 Surface max.:
 Max. surface:
 2.0 m²

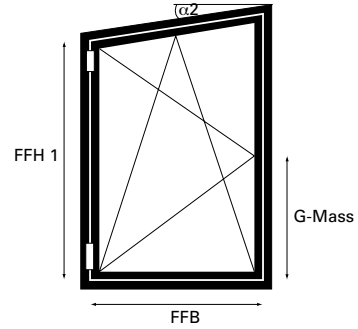

FFB = 1250 mm
 FFH 2 = 2760 mm
 Max. Fläche:
 Surface max.:
 Max. surface:
 2.0 m²

	 EN 12208	 EN 12207	 EN 12210
Anschweissband (Drehfenster) Paumelle à souder (Fenêtre à la française) Weld-on hinge (Side-hung window)	Klasse 9A Classe 9A Class 9A	Klasse 4 Classe 4 Class 4	Klasse C4/B4 Classe C4/B4 Class C4/B4
Fensterbeschlag Ferrure de fenêtre Window fitting	Klasse 9A Classe 9A Class 9A	Klasse 4 Classe 4 Class 4	Klasse C4/B4 Classe C4/B4 Class C4/B4
Größenänderungen Variations dimensionnelles Size changes	-100%	-100%	-100%

Leistungswerte für Sondergeometrien

Caractéristiques de performances pour géométrie spéciale

Performances values for special geometry

Schlagregendichtheit
 Luftdurchlässigkeit
 Widerstand bei Windlast

Etanchéité à la pluie battante
 Perméabilité à l'air
 Résistance à la pression du vent

Watertightness
 Air permeability
 Resistance to wind load

Kippfenster
 Fenêtre à soufflet
 Bottom-hung window

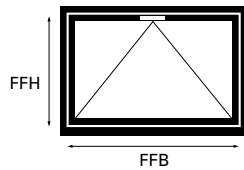

	 EN 12208	 EN 12207	 EN 12210
Anschweisband Schnäpper* Paumelle à souder Loqueteau d'imposte* Weld-on hinge Catch*	Klasse 9A Classe 9A Class 9A	Klasse 4 Classe 4 Class 4	Klasse C3/B3 Classe C3/B3 Class C3/B3
Größenänderungen Variations dimensionnelles Size changes	-100%	-100%	-100%

FFB = 2760 mm
 FFH = 960 mm

Max. Fläche:
 Surface max.:
 Max. surface:
 2.84 m²

* max. Verriegelungsabstand = 1810 mm
 * distance de verrouillage max. = 1810 mm
 * max. distance between locking points = 1810 mm

	 EN 12208	 EN 12207	 EN 12210
Anschweisband Oberlichtöffner F200* Paumelle à souder Ferrure d'imposte F200* Weld-on hinge Top light opener F200*	Klasse 9A Classe 9A Class 9A	Klasse 4 Classe 4 Class 4	Klasse C4/B4 Classe C4/B4 Class C4/B4
Größenänderungen Variations dimensionnelles Size changes	-100%	-100%	-100%

FFB = 2800 mm
 FFH = 960 mm

Max. Fläche:
 Surface max.:
 Max. surface:
 2.84 m²

* max. Verriegelungsabstand = 1440 mm
 * distance de verrouillage max. = 1440 mm
 * max. distance between locking points = 1440 mm

Leistungswerte für Sondergeometrien

Caractéristiques de performances pour géométrie spéciale

Performances values for special geometry





Schlagregendichtheit
 Luftdurchlässigkeit
 Widerstand bei Windlast

Étanchéité à la pluie battante
 Perméabilité à l'air
 Résistance à la pression du vent

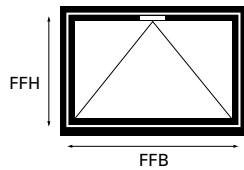
Watertightness
 Air permeability
 Resistance to wind load

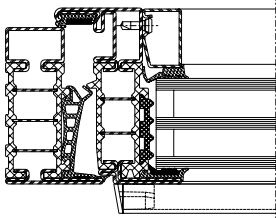
Kippfenster
 Fenêtre à soufflet
 Bottom-hung window



	 EN 12208	 EN 12207	 EN 12210	
	Anschweisband Kettenantrieb EM/2* Paumelle à souder Entraînement à chaîne EM/2* Weld-on hinge Chaîne drive EM/2*	Klasse 9A Classe 9A Class 9A	Klasse 4 Classe 4 Class 4	Klasse C4/B4 Classe C4/B4 Class C4/B4
	Größenänderungen Variations dimensionnelles Size changes	-100%	-100%	-100%

FFB = 2760 mm
 FFH = 960 mm

Max. Fläche:
 Surface max.:
 Max. surface:
 2.84 m²

* max. Verriegelungsabstand = 1810 mm
 * distance de verrouillage max. = 1810 mm
 * max. distance between locking points = 1810 mm

Leistungswerte für Sondergeometrien

Caractéristiques de performances pour géométrie spéciale

Performances values for special geometry

Schlagregendichtheit
 Luftdurchlässigkeit
 Widerstand bei Windlast

Etanchéité à la pluie battante
 Perméabilité à l'air
 Résistance à la pression du vent

Watertightness
 Air permeability
 Resistance to wind load

Kippfenster
 Fenêtre à soufflet
 Bottom-hung window

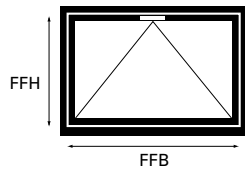

	 EN 12208	 EN 12207	 EN 12210
Kippflügelband Standard Schnapper* Charnière d'imposte Standard Loqueteau d'imposte* Bottom-hung hinge Standard Catch*	Klasse 8A Classe 8A Class 8A	Klasse 2 Classe 2 Class 2	Klasse C3/B3 Classe C3/B3 Class C3/B3
Größenänderungen Variations dimensionnelles Size changes	-100%	-100%	-100%

FFB = 2760 mm
 FFH = 960 mm

Max. Fläche:
 Surface max.:
 Max. surface:
 2.84 m²

* max. Verriegelungsabstand = 1810 mm
 * distance de verrouillage max. = 1810 mm
 * max. distance between locking points = 1810 mm

	 EN 12208	 EN 12207	 EN 12210
Kippflügelband Standard Oberlichtöffner F200* Charnière d'imposte Standard Ferrure d'imposte F200* Bottom-hung hinge Standard Top light opener F200*	Klasse 6A Classe 6A Class 6A	Klasse 2 Classe 2 Class 2	Klasse C2/B2 Classe C2/B2 Class C2/B2
Größenänderungen Variations dimensionnelles Size changes	-100%	-100%	-100%

FFB = 2760 mm
 FFH = 960 mm

Max. Fläche:
 Surface max.:
 Max. surface:
 2.84 m²

* max. Verriegelungsabstand = 1440 mm
 * distance de verrouillage max. = 1440 mm
 * max. distance between locking points = 1440 mm

Leistungswerte für Sondergeometrien

Caractéristiques de performances pour géométrie spéciale

Performances values for special geometry





Schlagregendichtheit
 Luftdurchlässigkeit
 Widerstand bei Windlast

Étanchéité à la pluie battante
 Perméabilité à l'air
 Résistance à la pression du vent

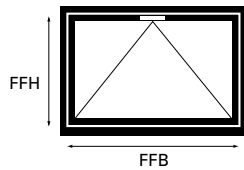
Watertightness
 Air permeability
 Resistance to wind load

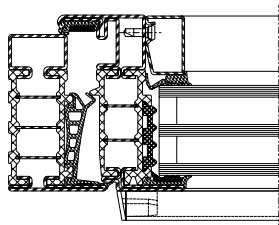
Kippfenster
 Fenêtre à soufflet
 Bottom-hung window



	 EN 12208	 EN 12207	 EN 12210	
	Kippflügelband Standard Kettenantrieb EM/2* Charnière d'imposte Standard Entraînement à chaîne EM/2* Bottom-hung hinge Standard Chaîne drive EM/2*	Klasse 7A Classe 7A Class 7A	Klasse 2 Classe 2 Class 2	Klasse C3/B3 Classe C3/B3 Class C3/B3
	Größenänderungen Variations dimensionnelles Size changes	-100%	-100%	-100%

FFB = 2760 mm
 FFH = 960 mm

Max. Fläche:
 Surface max.:
 Max. surface:
 2.84 m²

- * max. Verriegelungsabstand = 1810 mm
- * distance de verrouillage max. = 1810 mm
- * max. distance between locking points = 1810 mm

U_f-Werte
(nach EN ISO 10077-2:2018-01)

Auf den folgenden Seiten finden Sie die U_f-Werte für die verschiedenen Anwendungen von Janisol HI-Fenster.

Sie basieren auf folgenden Grundlagen:

- Stahl
- Profile bandverzinkter Stahl, unbeschichtet
 - Stahl-Glasleisten
 - Trockenverglasung

Valeurs U_f
(selon EN ISO 10077-2:2018-01)

Vous trouverez les valeurs U_f pour les différentes applications Janisol HI fenêtres dans les pages qui suivent.

Elles se basent sur les principes suivants:

- Acier
- Profilés en bande d'acier zingué, sans revêtement
 - Parcloses en acier
 - Vitrage à sec

U_f values
(according to EN ISO 10077-2:2018-01)

On the following pages you will find the U_f values for the various applications for Janisol HI windows.

They are based on the following:

- Steel
- Strip galvanised steel profiles, uncoated
 - Steel glazing beads
 - Glazing with dry glazing

U_f-Werte
 (nach EN ISO 10077-2:2018-01)

Valeurs U_f
 (selon EN ISO 10077-2:2018-01)

U_f values
 (according to EN ISO 10077-2:2018-01)

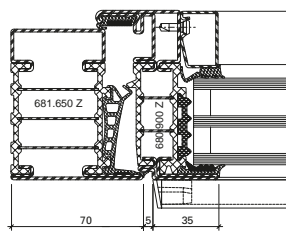
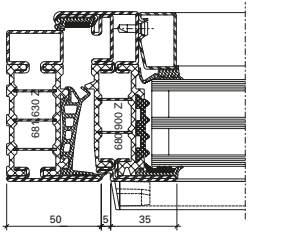
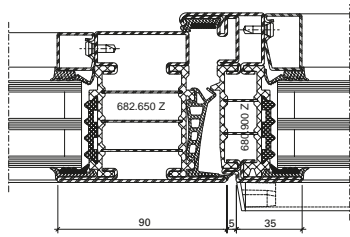
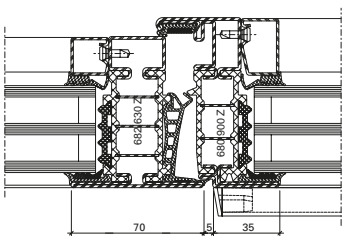
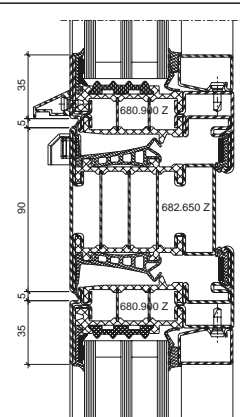
	Füllelementstärken Elements de remplissages Infill elements			
	≥ 46 mm	≥ 36 mm	≥ 36 mm*	≥ 24 mm*
	1,2 W/m²K	1,2 W/m²K	1,3 W/m²K	1,3 W/m²K
	1,3 W/m²K	1,3 W/m²K	1,4 W/m²K	1,5 W/m²K
	1,1 W/m²K	1,2 W/m²K	1,3 W/m²K	1,4 W/m²K
	1,2 W/m²K	1,3 W/m²K	1,4 W/m²K	1,5 W/m²K
	1,2 W/m²K	1,3 W/m²K	1,4 W/m²K	1,4 W/m²K

* ohne Dämmprofil
 * sans profilé isolant
 * without insulating profile

U_f-Werte
 (nach EN ISO 10077-2:2018-01)

Valeurs U_f
 (selon EN ISO 10077-2:2018-01)

U_f values
 (according to EN ISO 10077-2:2018-01)

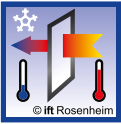
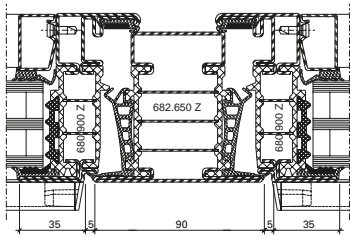
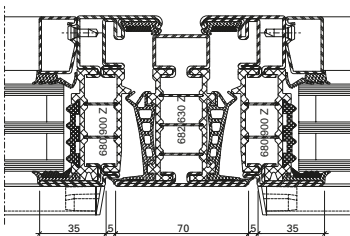
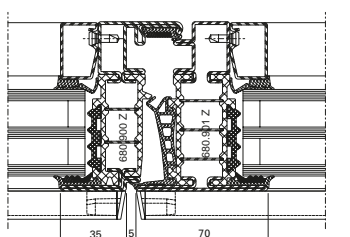
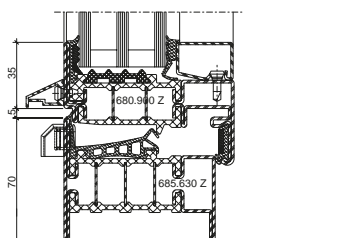
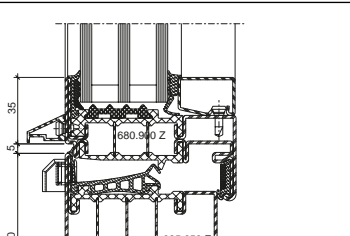
	Füllelementstärken Elements de remplissages Infill elements			
	≥ 46 mm	≥ 36 mm	≥ 36 mm*	≥ 24 mm*
	1,2 W/m ² K	1,3 W/m ² K	1,4 W/m ² K	1,4 W/m ² K
	1,3 W/m ² K	1,4 W/m ² K	1,5 W/m ² K	1,5 W/m ² K
	1,2 W/m ² K	1,3 W/m ² K	1,5 W/m ² K	1,6 W/m ² K
	1,2 W/m ² K	1,2 W/m ² K	1,3 W/m ² K	1,4 W/m ² K
	1,1 W/m ² K	1,1 W/m ² K	1,2 W/m ² K	1,2 W/m ² K

* ohne Dämmprofil
 * sans profilé isolant
 * without insulating profile

U_f-Werte
 (nach EN ISO 10077-2:2018-01)

Valeurs U_f
 (selon EN ISO 10077-2:2018-01)

U_f values
 (according to EN ISO 10077-2:2018-01)

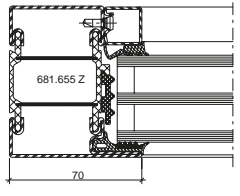
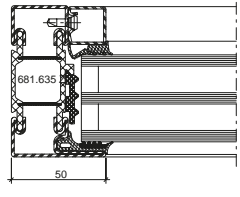
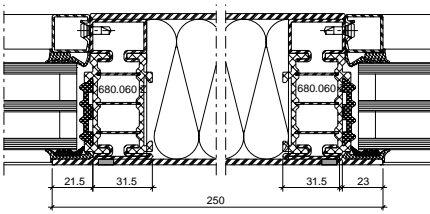
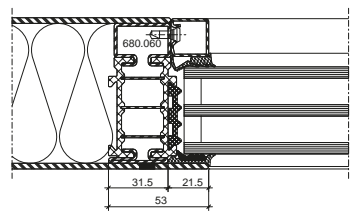
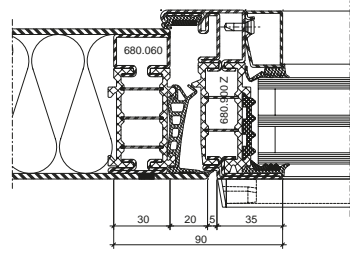
	Füllelementstärken Elements de remplissages Infill elements			
	≥ 46 mm	≥ 36 mm	≥ 36 mm*	≥ 24 mm*
	1,2 W/m²K	1,3 W/m²K	1,4 W/m²K	1,6 W/m²K
	1,4 W/m²K	1,5 W/m²K	1,7 W/m²K	1,9 W/m²K
	0,74 W/m²K	0,77 W/m²K	0,85 W/m²K	0,91 W/m²K
	1,2 W/m²K	1,3 W/m²K	1,4 W/m²K	1,5 W/m²K
	1,3 W/m²K	1,4 W/m²K	1,5 W/m²K	1,6 W/m²K

* ohne Dämmprofil
 * sans profilé isolant
 * without insulating profile

U_f-Werte
 (nach EN ISO 10077-2:2018-01)

Valeurs U_f
 (selon EN ISO 10077-2:2018-01)

U_f values
 (according to EN ISO 10077-2:2018-01)

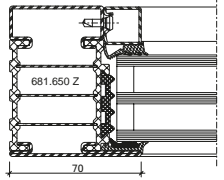
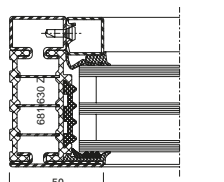
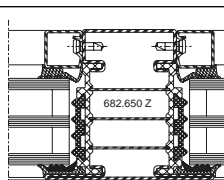
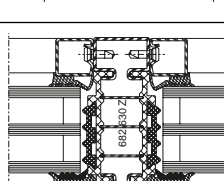
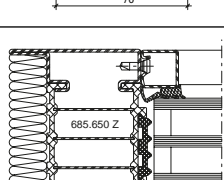
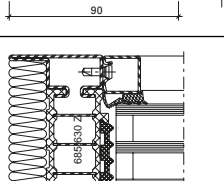
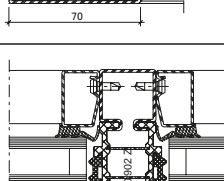
	Füllelementstärken Elements de remplissages Infill elements			
	≥ 46 mm	≥ 36 mm	≥ 36 mm*	≥ 24 mm*
	0,89 W/m ² K	0,95 W/m ² K	1,1 W/m ² K	1,2 W/m ² K
	1,0 W/m ² K	1,1 W/m ² K	1,3 W/m ² K	1,4 W/m ² K
	0,84 W/m ² K	0,93 W/m ² K	1,1 W/m ² K	1,3 W/m ² K
	0,93 W/m ² K	1,0 W/m ² K	1,3 W/m ² K	1,5 W/m ² K
	0,80 W/m ² K	0,85 W/m ² K	0,95 W/m ² K	1,0 W/m ² K
	0,88 W/m ² K	0,95 W/m ² K	1,1 W/m ² K	1,2 W/m ² K
	0,93 W/m ² K	1,1 W/m ² K	1,3 W/m ² K	1,4 W/m ² K

* ohne Dämmprofil
 * sans profilé isolant
 * without insulating profile



Schalldämmung

Ausführungsvarianten

Die nachfolgende Typenübersicht ergibt einen Überblick über die beurteilten Varianten.

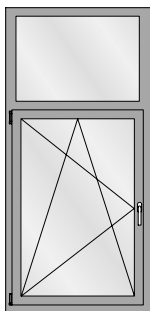
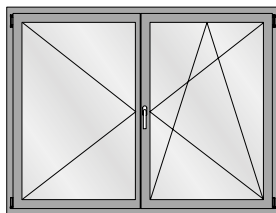
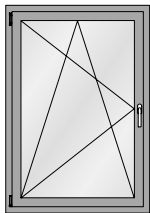

Isolation phonique

Modèles

L'aperçu des types suivant fournit une vue d'ensemble des variantes examinées.

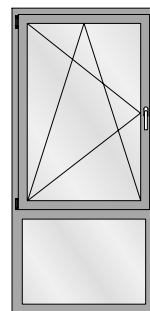
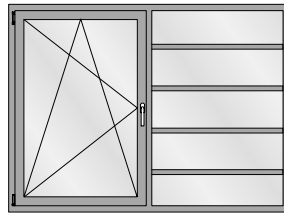
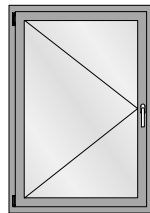

Sound insulation

Design range

The following overview of types provides an overview of the evaluated designs.



Tabelle A1
 Korrekturtabelle für Janisol HI-Fenster
 mit Mehrscheiben-Isolierglas

Tableau A1
 Tableau de correction pour les
 fenêtres Janisol HI avec vitrage isolant
 multi-vitres

Table A1
 Correction table for Janisol HI
 windows with multi-pane insulating
 glass

	1	2	7	8	9	10	11	12	13	14	15
	$R_{W(C, Ctr)}$ dB	Isolierglaseinheit Unité d'isolation Insulating glass unit $R_{W, P, Glas}$ dB	Korrekturen Corrections Corrections								
			K_{RA} dB	K_S dB	K_{FV} dB	K_{Nass} dB	$K_{G 0,4}$ dB	$K_{G 1,0}$ dB	$K_{G 1,8}$ dB	$K_{G 2,6}$ dB	$K_{G 3,2}$ dB
1	33 (-2; -6)	31	-2	0	-1	0	0	0	-1	-2	-3
2	34 (-2; -6)	32	-2	0	-1	0	0	0	-1	-2	-3
3	35 (-2; -6)	34	-2	0	-1	0	0	0	-1	-2	-3
4	36 (-2; -6)	35	-2	0	-1	-1	0	0	-1	-2	-3
5	37 (-2; -6)	37	-2	0	0	-1	0	0	-1	-2	-3
6	38 (-2; -6)	39	-2	0	0	-1	0	0	-1	-2	-3
7	39 (-2; -6)	40	-2	0	0	-1	0	0	-1	-2	-3
8	40 (-2; -4)	41	-2	0	0	-1	-1	0	-1	-2	-3
9	41 (-2; -4)	42	0	0	0	-1	-2	0	-1	-2	-3
10	42 (-2; -4)	43	0	-1	0	-1	-2	0	-1	-2	-3
11	43 (-2; -4)	44	0	-2	0	-1	-2	0	-1	-2	-3
12	44 (-2; -5)	45	0	-2	0	-1	-3	0	-1	-2	-3
13	45 (-2; -5)	49	0	-2	+1	-1	-3	0	-1	-2	-3
14	46 (-2; -6)	50	-1	-3	0	-1	-4	-1	-1	-2	-3

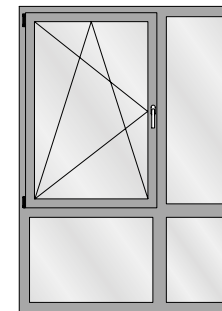
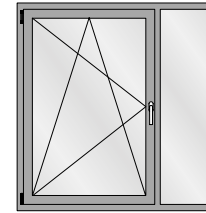
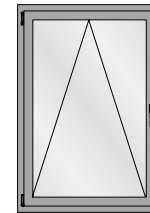
Der aus der Tabelle A1 abzulesende Wert für die Schalldämmung $R_{W, Fenster}$ beträgt:

La valeur à relever sur le tableau A1 concernant l'isolement contre les sons aériens $R_{W, Fenêtre}$ est la suivante:

The value taken from table A1 for the sound insulation $R_{W, Window}$ is:

$$R_{W, Fenster} = R_W + K_{RA} + K_S + K_{FV} + K_{Nass} + K_{G 0,4} + K_{G 1,8} + K_{G 2,6} + K_{G 3,2} \text{ dB}$$

K_{RA} Korrekturwert für einen Rahmenanteil < 30%. Der Rahmenanteil ist die Gesamtfläche des Fensters abzüglich der sichtbaren Scheibengröße. K_{RA} darf bei Festverglasungen nicht berücksichtigt werden.

K_{RA} Valeur de correction pour un pourcentage de cadre < 30%. Le pourcentage du cadre est la surface totale de la fenêtre déduite de la dimension de vitre visible. K_{RA} ne doit pas être pris en compte sur les vitrages fixes.

K_{RA} Correction value for a frame proportion < 30%. The frame proportion is the total surface area of the window less the visible pane area. K_{RA} must not be taken into account for fixed glazing.

K_S Korrekturwert für Stulpfenster

K_S Valeur de correction pour fenêtres à deux vantaux

K_S Correction value for double-vent windows

K_{FV} Korrekturwert für Festverglasungen mit erhöhtem Scheibenanteil

K_{FV} Valeur de correction pour vitrages fixes à fort pourcentage de vitre

K_{FV} Correction value for fixed glazing with increased proportion of pane

K_{Nass} Korrekturwert für Nassverglasung

K_{Nass} Valeur de correction pour vitrage avec mastic

K_{Nass} Correction value for glazing with sealing

$K_{G 0,4}$ Korrekturwert für Einzelscheiben mit einer Glasfläche $\leq 0,4 \text{ m}^2$. Die Korrektur gilt auch für Konstruktionen mit glasteilenden Sprossen.

$K_{G 0,4}$ Valeur de correction pour vitres individuelles avec une surface vitrée $\leq 0,4 \text{ m}^2$. La correction s'applique aussi aux constructions à meneaux séparant les vitres.

$K_{G 0,4}$ Correction value for single panes with a glass area $\leq 0,4 \text{ m}^2$. The correction also applies to buildings with glazing bars

$K_{G 1,0}$ Korrekturwert für Einzelscheiben mit einer Glasfläche $\geq 1,0 \text{ m}^2$

$K_{G 1,0}$ Valeur de correction pour vitres individuelles avec surface vitrée $\geq 1,0 \text{ m}^2$

$K_{G 1,0}$ Correction value for single panes with a glass area $\geq 1,0 \text{ m}^2$

$K_{G 1,8}$ Korrekturwert für Einzelscheiben mit einer Glasfläche $\geq 1,8 \text{ m}^2$

$K_{G 1,8}$ Valeur de correction pour vitres individuelles avec surface vitrée $\geq 1,8 \text{ m}^2$

$K_{G 1,8}$ Correction value for single panes with a glass area $\geq 1,8 \text{ m}^2$

$K_{G 2,6}$ Korrekturwert für Einzelscheiben mit einer Glasfläche $\geq 2,6 \text{ m}^2$

$K_{G 2,6}$ Valeur de correction pour vitres individuelles avec surface vitrée $\geq 2,6 \text{ m}^2$

$K_{G 2,6}$ Correction value for single panes with a glass area $\geq 2,6 \text{ m}^2$

$K_{G 3,2}$ Korrekturwert für Einzelscheiben mit einer Glasfläche $\geq 3,2 \text{ m}^2$

$K_{G 3,2}$ Valeur de correction pour vitres individuelles avec surface vitrée $\geq 3,2 \text{ m}^2$

$K_{G 3,2}$ Correction value for single panes with a glass area $\geq 3,2 \text{ m}^2$

R_W bewertetes Schalldämm-Mass des Fensters in Abhängigkeit von der Schalldämmung $R_{W,P, Glas}$

R_W Mesure d'isolement contre les sons aériens des fenêtres évaluée suivant l'isolement phonique $R_{W,P, vitrage}$

R_W Airborne sound reduction index of windows depending on the sound insulation $R_{W,P, glazing}$

$R_{W,P, Glas}$ bewertetes Schalldämm-Mass (Prüfwert) der Isolierverglasung. Die Werte müssen über eine Prüfung nach ISO 140-3 an einem Prüfmuster im Format 1230 x 1480 mm ermittelt und durch einen Prüfbericht einer anerkannten Prüfstelle nachgewiesen werden. Alternativ können generische Daten nach DIN EN 12758 verwendet werden.

$R_{W,P, vitrage}$ Mesure d'isolement contre les sons aériens (valeur d'essai) du vitrage isolant évaluée. Les valeurs doivent être déterminées par un essai suivant ISO 140-3 sur un spécimen de format 1230x1480 mm et attestées par le procès-verbal d'un bureau de vérification homologué. Alternativement, il est possible d'utiliser des données génériques suivant DIN EN 12758.

$R_{W,P, glazing}$ Airborne sound reduction index (test value) of insulating glazing. The values must be calculated using a test conducted in accordance with ISO 140-3 for a specimen with the dimensions 1230 x 1480 mm and confirmed by a test report of a recognised test centre. Alternatively, generic data can be used in accordance with DIN EN 12758.

Jansen AG

Steel Systems
Industriestrasse 34
9463 Oberriet
Schweiz
jansen.com

JANSEN
METALFORM

Grafische Planungsdaten wie z.B. Anwendungsbeispiele, Konstruktionsdetails, Anschlüsse am Bau, die in unseren physischen oder elektronischen Dokumentationsunterlagen enthalten sind, sind schematische Darstellungen. Gleiches gilt für digitale Medien wie CAD Dateien oder BIM Modelle.

Sie sollen den ausführenden Metallbauer und/oder Fachplaner bei der Planung und Ausführung eines Projektes unterstützen. Sie sind im konkreten Anwendungsfall durch den ausführenden Metallbauer und/oder Fachplaner auf die Verwendbarkeit im konkreten betroffenen Projekt hinsichtlich rechtlichen/regulatorischen aber auch technischen objektspezifischen Anforderungen zu überprüfen und ggfs. eigenverantwortlich anzupassen.

Bei der Überprüfung, der spezifischen Planung und der Umsetzung sind die objektspezifischen Rahmenbedingungen (Material der Bausubstanz, Dimension des Einbauelements, Farbe, Exposition, Lasteinwirkung, etc.) sowie der geltende Stand der Technik einschliesslich aller anwendbaren Normen und technischen Richtlinien eigenverantwortlich zu beachten.

Falls das vorliegende Dokument Differenzen zur aktuellen deutschen Version (Artikel Nr. K1214220) aufweist, gilt in jedem Fall der deutsche Originaltext in der jeweils geltenden Fassung im Jansen Docu Center.

Alle Ausführungen dieser Dokumentation haben wir sorgfältig und nach bestem Wissen zusammengestellt. Wir können aber keine Verantwortung für die Benutzung der vermittelten Vorschläge und Daten übernehmen. Wir behalten uns technische Änderungen ohne Vorankündigung vor.

Les données de planification graphiques, comme les exemples d'application, détails de construction et raccordements au bâtiment, fournies dans notre documentation physique et numérique sont des représentations schématiques. Il en va de même pour les médias numériques comme les fichiers CAD ou modèles BIM.

Leur but est de faciliter la planification et réalisation d'un projet par les constructeurs métalliques et/ou concepteurs. Concrètement, elles doivent être vérifiées par le constructeur métallique et/ou le concepteur et, le cas échéant, modifiées de son propre chef pour s'assurer qu'elles concordent avec le projet concerné et qu'elles répondent aux exigences techniques spécifiques ainsi qu'aux dispositions légales et réglementaires.

Lors de la vérification, de la planification spécifique et de la mise en œuvre, il y a lieu de tenir compte des conditions spécifiques à l'objet (matériaux du bâtiment, dimension de l'élément d'insert, couleur, exposition, effet de charge, etc.) ainsi que de l'état actuel de la technique, y compris toutes les normes et directives techniques applicables.

En cas de divergence entre le présent document et la version allemande (no d'article K1214220), c'est dans tous les cas le texte original allemand qui prévaut dans sa version actuelle disponible dans le Jansen Docu Center.

Nous avons apporté le plus grand soin à l'élaboration de cette documentation. Cependant, nous déclinons toute responsabilité pour l'utilisation faite de nos propositions et de nos données.

Nous nous réservons le droit de procéder à des modifications techniques sans préavis.

Graphical planning data such as application examples, construction details, connections on site that are contained in our physical or electronic documentation components are schematic representations. The same applies to digital media such as CAD files or BIM models.

They are intended to support the metal worker and/or design engineer in planning and executing projects. In the specific case of application they are to be checked by the metal worker and/or design engineer in terms of their usability in the specific project concerned with regard to legal/regulatory and technical property-specific requirements and adjusted if necessary at the latter's own responsibility.

The property-specific underlying conditions (construction material, dimensions of installation element, colour, exposure, load effect etc.) and current state of the art including all applicable norms and technical guidelines are to be taken into consideration at the metal worker and/or design engineer's own responsibility during the review, specific planning and implementation.

If there are any differences between this document and the current German version (item number K1214220), the latest version of the original German text in the Jansen Docu Center shall prevail.

All the information contained in this documentation is given to the best of our knowledge and ability. However, we decline all responsibility for the use made of these suggestions and data.

We reserve the right to effect technical modifications without prior warning.

Inhaltsverzeichnis
Sommaire
Content

Janisol HI Fenster
Janisol HI fenêtres
Janisol HI windows

Systemübersicht

Merkmale
Leistungseigenschaften
Systemausführungen
Typenübersicht

Sommaire du système

Caractéristiques
Caractéristiques de performance
Exécutions de système
Sommaire des types

Summary of system

Characteristics
Performance characteristics
System versions
Summary of types

2

Profilsortiment

Assortiment de profilé

Range of profiles

9

Beispiele

Schnittpunkte
Konstruktionsdetails
Anschlüsse am Bau

Exemples

Coupes de détails
Détails de construction
Raccords au mur

Examples

Section details
Construction details
Attachment to structure

12

Leistungseigenschaften

Caractéristiques de performance

Performance characteristics

38

Merkmale
Caractéristiques
Characteristics

Janisol HI Fenster
Janisol HI fenêtres
Janisol HI windows

- Hervorragende wärmetechnische Eigenschaften für maximale Anforderungen
- Bautiefe Flügel 90 mm, Festverglasung 80 mm
- Schmale Profilansichten: Rahmen 50 resp. 70 mm, Pfosten/Riegel 70 resp. 90 mm, Flügel 35 mm, Stulpflügelpartie 110 mm
- Isolierstege mit besten bauphysikalischen Eigenschaften aus glasfaserverstärktem Kunststoff
- Mit Euro-Beschlagsnute für Dreh-, Drehkipp-, Stulp- und Kippflügel-Fenster
- Fensterflügel Größen bis max. 2800 mm Höhe
- Fensterflügel-Gewichte: verdeckt liegend bis 180 kg, aufgesetzt bis 150 kg
- Glasdicke für Fensterflügel 24-67 mm, für Festverglasung 24-57 mm
- Systemprüfung nach Produktnorm EN 14351-1 für alle Fenster-Öffnungsarten
- Sehr gute statische Werte, hohe mechanische Festigkeiten
- Dauerfunktionsprüfung nach EN 12400 Drehfenster Klasse 4 Drehkippfenster Klasse 3
- Für Nasslack- oder Pulverbeschichtung geeignet
- Excellentes propriétés thermiques répondant à des exigences maximum
- Profondeur de montage vantail 90 mm, vitrage fixe 80 mm
- Profilés très fins: Cadre 50 et 70 mm, montant/traverse 70 ou 90 mm, vantail 35 mm, partie à deux vantaux à la française 110 mm
- Traverses isolantes aux excellentes propriétés physiques en matière plastique renforcé par fibres de verre
- Avec rainure de ferrure Euro pour fenêtres à la française, oscillo-battantes, à deux vantaux et à soufflet
- Tailles d'ouvrant de fenêtre jusqu'à max. 2800 mm de hauteur
- Poids des ouvrants de fenêtre: non apparents jusqu'à 180 kg, plaqués jusqu'à 150 kg
- Épaisseur de vitrage pour ouvrants de fenêtre 24-67 mm, pour vitrage fixe 24-57 mm
- Contrôle du système selon la norme produit EN 14351-1 pour tous les types d'ouverture de fenêtre
- Très bonnes valeurs statiques, résistances mécaniques élevées
- Durabilité mécanique selon EN 12400 Fenêtres à la française classe 4 Fenêtres oscillo-battantes classe 3
- Convient au revêtement à la peinture liquide ou poudre
- Outstanding thermal properties for the most exacting requirements
- Basic depth of vent 90 mm, fixed glazing 80 mm
- Narrow profile face widths: frame 50 or 70 mm, mullion/transom 70 or 90 mm, vent 35 mm, double-vent meeting stile assembly 110 mm
- Insulating bars with optimum structural properties made from glass fibre-reinforced plastic
- With Euro fittings groove for side-hung, turn/tilt, double-vent and bottom-hung windows
- Window vent dimensions up to max. 2800 mm in height
- Window vent weights: concealed up to 180 kg, surface-mounted up to 150 kg
- Glass thickness for window vent 24-67 mm, for fixed glazing 24-57 mm
- System testing in accordance with product standard EN 14351-1 for all window opening types
- Excellent structural values, high levels of mechanical strength
- Mechanical durability in accordance with EN 12400 Side-hung windows class 4 Turn/tilt windows class 3
- Suitable for wet paint or powder coating

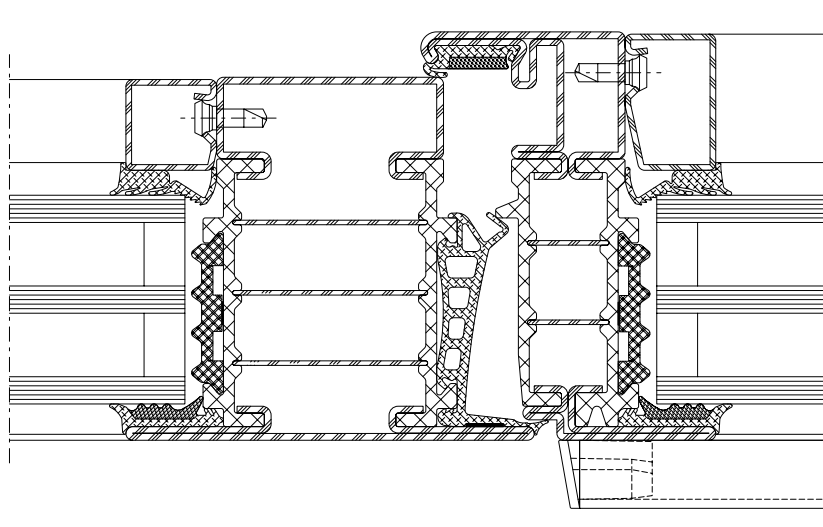

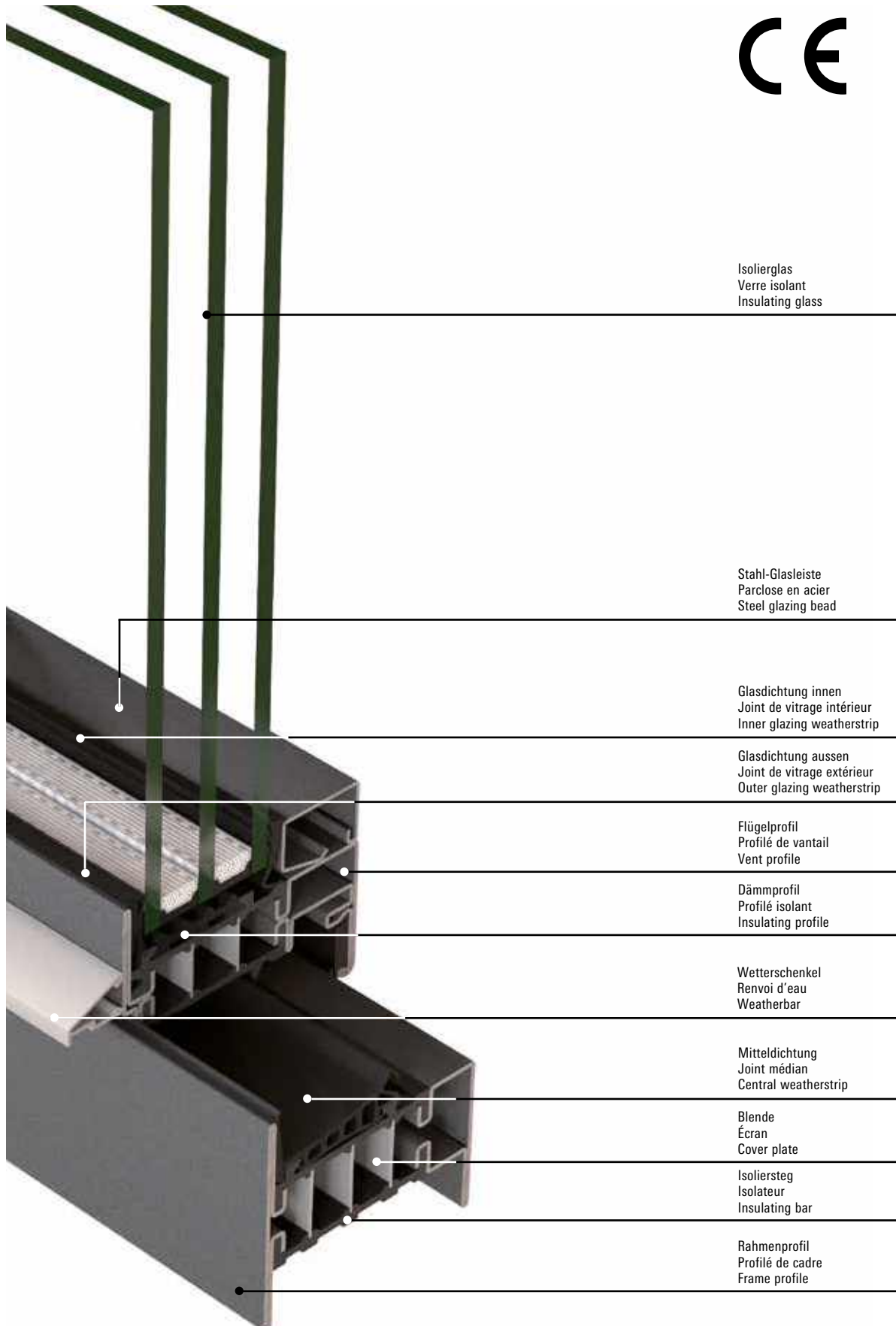

Isolierglas
Verre isolant
Insulating glass

Stahl-Glasleiste
Parclose en acier
Steel glazing bead

Glasdichtung innen
Joint de vitrage intérieur
Inner glazing weatherstrip

Glasdichtung aussen
Joint de vitrage extérieur
Outer glazing weatherstrip

Flügelprofil
Profilé de vantail
Vent profile

Dämmprofil
Profilé isolant
Insulating profile













Wetterschenkel
Renvoi d'eau
Weatherbar

Mitteldichtung
Joint médian
Central weatherstrip

Blende
Écran
Cover plate

Isoliersteg
Isolateur
Insulating bar

Rahmenprofil
Profilé de cadre
Frame profile

Norm	Eigenschaft Caractéristique Characteristic	Klassifizierung/Wert Classification / Valeur Classification / Value																
		npd	C1 (400)	C2 (800)	C3 (1200)	C4 (1600)	C5 (2000)	1A (0)	2A (50)	3A (100)	4A (150)	5A (200)	6A (250)	7A (300)	8A (450)	9A (600)	Exxx (>750)	
 EN 12210	Widerstandsfähigkeit bei Windlast Résistance à la pression du vent Resistance to wind load	npd	C1 (400)	C2 (800)	C3 (1200)	C4 (1600)	C5 (2000)											
 EN 12208	Schlagregendichtheit Etanchéité à la pluie battante Watertightness	npd	1A (0)	2A (50)	3A (100)	4A (150)	5A (200)	6A (250)	7A (300)	8A (450)	9A (600)	Exxx (>750)						
 EN ISO 10140	Schalldämmung R_w (C, C_{tr}) (dB) Isolation phonique R_w (C, C_{tr}) (dB) Sound insulation R_w (C, C_{tr}) (dB)	npd	bis R_w 46 dB (-2; -6) jusqu'à R_w 46 dB (-2; -6) up to R_w 46 dB (-2; -6)															
 EN ISO 10077-2	Wärmedurchgangskoeffizient U_f (W/(m²·K)) Transmission thermique U_f (W/(m²·K)) Thermal production U_f (W/(m²·K))	npd	ab 0,74 W/m ² ·K à partir de 0,74 W/m ² ·K from 0,74 W/m ² ·K															
 EN 12207	Luftdurchlässigkeit Perméabilité à l'air Air permeability	npd	1 (150)	2 (300)	3 (600)	4 (600)												
 EN 14024	Tragfähigkeit von Sicherheitsvorrichtungen Capacité portante des dispositifs de sécurité Load-bearing capacity of safety devices		Anforderung erfüllt Exigence remplie Requirement satisfied															
 EN 14024	Metallprofile mit thermischer Trennung Profilés en métal. avec rupture de pont thermique Metal profiles with thermal barrier		CW / TC2															
 EN 12400	Dauerfunktionsprüfung Durabilité mécanique Mechanical durability		D 1 5'000	2 10'000	3 20'000	4 50'000	5 100'000	6 200'000	7 500'000	8 1'000'000								
 EN 13115	Bedienkräfte Forces de manœuvre Operating forces	npd	0	1	2													
 EN 1627	Einbruchhemmung Anti-effraction Burglar resistance	npd	1	2	3	4	5	6										
 ISO 16000	Gefährliche Substanzen Substances dangereuses Dangerous substances	npd	Anforderung erfüllt Exigence remplie Requirement satisfied															
 DIN 18008-4	Vorgefertigte absturzsichernde Verglasung Vitrage anti-chutes préfabriqué Prefabricated glazing suitable for safety barrier loading												Anhang D.1.2 erfüllt Annexe D.1.2 remplie Appendix D.1.2 satisfied					

npd = keine Leistung festgestellt
(no performance determined)

npd = Aucune performance déterminée
(no performance determined)

npd = no performance determined



Einbruchhemmende Janisol HI Fenster

- Flügelgrößen bis 1475 x 2800 mm
- Dreh-, Drehkipp-, Stulpfenster und Festverglasungen
- Beschlag als Komplettseinheit geliefert
- Prüfungen nach EN 1627 bis 1630 bis RC3

Fenêtres anti-effraction Janisol HI

- Dimensions de vantail jusqu'à 1475 x 2800 mm
- Fenêtres ouvrant à la française, oscillo-battantes, à deux vantaux et vitrages fixes
- Ferrures livrées comme unité complète
- Contrôlé selon les normes EN 1627 à 1630 jusqu'à RC3

Burglar-resistant Janisol HI windows

- Vent sizes up to 1475 x 2800 mm
- Side-hung, turn/tilt and double-vent windows and fixed glazing
- Fitting supplied as complete unit
- Tests in accordance with EN 1627 to 1630 up to RC3

Jansen Docu Center

Die Plattform zum effizienten Arbeiten mit Jansen Dokumentationen. Im Jansen Docu Center stehen alle Produktinformationen jederzeit digital in der aktuellsten Version zur Verfügung: von Architekten-Informationen über Bestell- und Fertigungskatalogen bis hin zu Anleitungen und Prospekten sowie Videos.

Die Inhalte können einfach und schnell aufgerufen werden. Ein für den Anwender komfortables papierloses Arbeiten, das zahlreiche Vorteile bietet.

Download CAD Daten

DXF

DWG

Sie können die Zeichnungen in den Formaten DXF und/oder DWG herunterladen. Klicken Sie auf das entsprechende Icon und der Download erfolgt.

Die Hinweise «Artikelbibliothek/Türbeschläge/Fensterbeschläge» bedeuten, dass Sie mit einem Klick die gesamte Artikelbibliothek des entsprechenden Systems herunterladen (Profile, Beschläge, Glasleisten, Zubehör etc.).

Info und Beratung

Gerne beraten wir Sie persönlich und stehen Ihnen bei Fragen zur Verfügung. Bitte schreiben Sie uns Ihre Anliegen an: info@jansen.com

Jansen Docu Center

La plate-forme pour travailler efficacement avec les documentations Jansen. Le Jansen Docu Center met à votre disposition les informations sur les produits, en format numérique et dans une version actualisée: des catalogues de commande et de fabrication aux instructions et prospectus, en passant par les informations destinées aux architectes et vidéos.

Les contenus sont facilement et rapidement accessibles. Une manière de travailler confortable et offrant de nombreux avantages.

Télécharger fichiers DAO

DXF

DWG

Vous pouvez télécharger les dessins aux formats DXF et/ou DWG. Cliquez sur l'icône correspondante et le téléchargement s'effectuera.

Les indications «Bibliothèque des articles/Ferures de porte/Ferrures de fenêtres» signifie que vous téléchargez la totalité de la bibliothèque des articles du système donné (profilés, ferrures, parclofes, accessoires etc.).

Info et conseils

Nous vous conseillons volontiers individuellement et sommes à votre disposition si vous avez des questions à poser. Veuillez nous envoyer votre requête à: info@jansen.com

Jansen Docu Center

The platform for working efficiently with Jansen documentation. The latest version of all the product information is available digitally at any time in the Jansen Docu Center – from order and fabrication manuals to architect information, instructions and brochures and videos.

The content can be retrieved quickly and easily. The user can work conveniently without paper, which has numerous benefits.

Download CAD files

DXF

DWG

You can download the drawings in DXF and/or DWG format. Click on the relevant icon to begin the download.

The items «Article library/Door fittings/Window fittings» means that you download the entire article library for the corresponding system with one click (profiles, fittings, glazing beads, accessories etc.).

Information and advice

We would be delighted to provide you with advice in person and are available to answer any questions you may have. Please write to us with your queries at: info@jansen.com

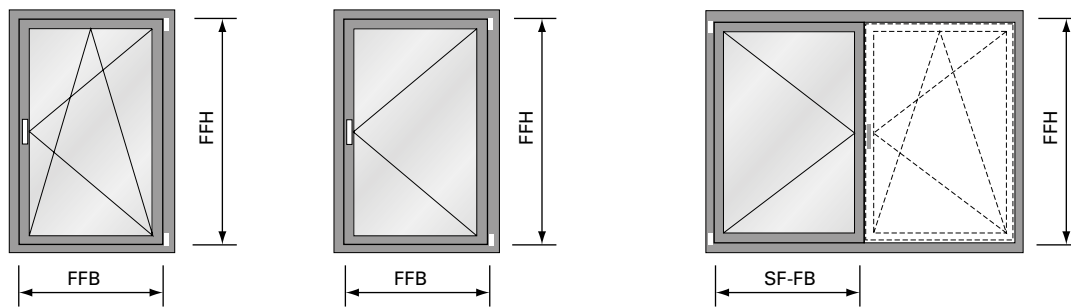

*Flügelgrößen Drehkipp-,
 Drehfenster und Stulpfenster:*

Max.	FFH = 2760 mm
	FFB = 1435 mm
	SF-FB = 1435 mm
Min.	FFH = 600 mm
	FFB = 600 mm
	SF-FB = 370 mm*
	SF-FB = 480 mm**
Max. Fläche:	3.0 m ²
Max. Gewicht:	180 kg
FFB/FFH:	≤ 2

*Grandeurs du vantail fenêtre
 oscillo-battante, à la française et
 fenêtre à deux vantaux:*

Max.	FFH = 2760 mm
	FFB = 1435 mm
	SF-FB = 1435 mm
Min.	FFH = 600 mm
	FFB = 600 mm
	SF-FB = 370 mm*
	SF-FB = 480 mm**
Surface max.:	3.0 m ²
Poids max.:	180 kg
FFB/FFH:	≤ 2

*Size of sash turn/tilt, side-hung and
 double-sash windows:*

Max.	FFH = 2760 mm
	FFB = 1435 mm
	SF-FB = 1435 mm
Min.	FFH = 600 mm
	FFB = 600 mm
	SF-FB = 370 mm*
	SF-FB = 480 mm**
Max. surface:	3.0 m ²
Max. weight:	180 kg
FFB/FFH:	≤ 2

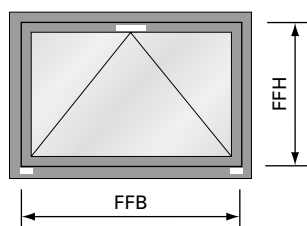

Flügelgröße Kipp-Fenster:

Max.	FFH = 2760 mm
	FFB = 2760 mm
Min.	FFH = 600 mm
	FFB = 600 mm
Max. Fläche:	3.0 m ²
Max. Gewicht:	80 kg
	(2 Bänder)
	120 kg
	(3 Bänder)
FFB/FFH:	≤ 2

*Grandeur du vantail fenêtre à
 soufflet:*

Max.	FFH = 2760 mm
	FFB = 2760 mm
Min.	FFH = 600 mm
	FFB = 600 mm
Surface max.:	3.0 m ²
Poids max.:	80 kg
	(2 paumelles)
	120 kg
	(3 paumelles)
FFB/FFH:	≤ 2

Size of sash bottom-hung window:

Max.	FFH = 2760 mm
	FFB = 2760 mm
Min.	FFH = 600 mm
	FFB = 600 mm
Max. surface:	3.0 m ²
Max. weight:	80 kg
	(2 hinges)
	120 kg
	(3 hinges)
FFB/FFH:	≤ 2

* Standard-Fensterbeschlag
 ** Verdeckt liegender Fensterbeschlag

* Ferrure de fenêtre Standard
 ** Ferrure de fenêtre non apparente

* Standard window fitting
 ** Concealed window fitting

Empfehlung Jansen:
 Flügelhöhe und Flügelbreite 1 mm ins
 Minus schneiden betreffend Sollmass.

Recommandation Jansen:
 Couper la hauteur et la largeur de
 vantail à 1 mm de moins que la cote
 de consigne.

Jansen recommendation:
 Cut sash height and sash width 1 mm
 into the minus relative to the target
 dimension.

Typenübersicht
Sommaire des types
Summary of types

Janisol HI Fenster
Janisol HI fenêtres
Janisol HI windows

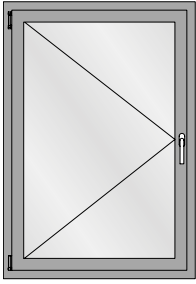

Drehflügel
 Fenêtre à la française
 Side-hung window

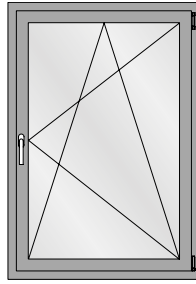

Drehkipp-Flügel
 Vantail oscillo-battant
 Turn/tilt window

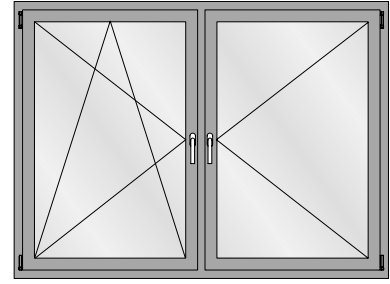

Drehkipp/Drehflügel (mit Pfosten)
 Vantail oscillo-battant/fenêtre à la française
 (avec montant)
 Side-hung/turn/tilt window (with mullion)

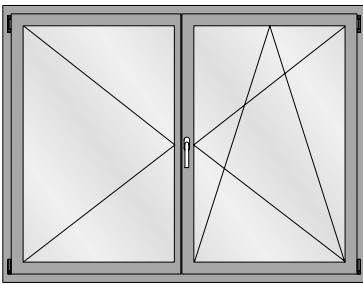

Drehkipp/Drehflügel (Stulpfenster)
 Vantail oscillo-battant/fenêtre à la française
 (Fenêtre à deux vantaux)
 Side-hung/turn/tilt window (Double-vent window)

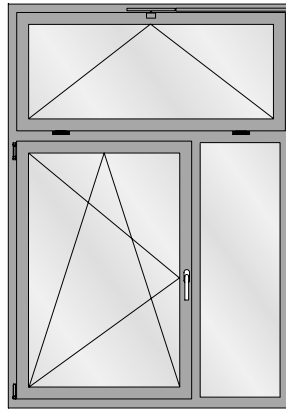

Drehkipp-Flügel mit Festverglasung und Oberlicht
 Vantail oscillo-battant avec vitrage fixe et imposte
 Turn/tilt window with fixed lights and top lights

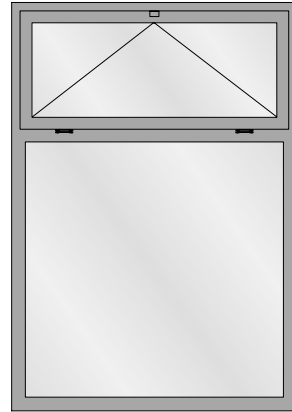

Festverglasung mit Oberlicht
 Vitrage fixe avec imposte
 Fixed lights with top light

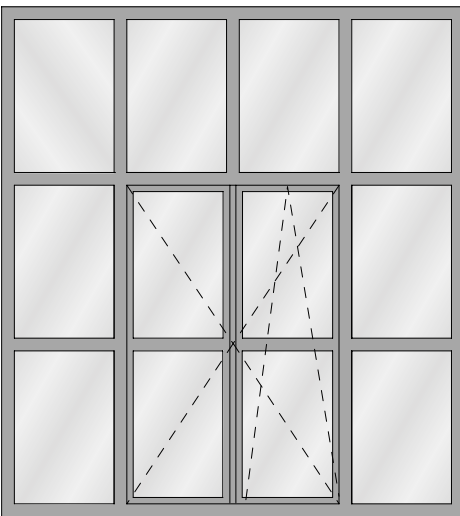

Drehkipp-Flügel mit Festverglasung
 Vantail oscillo-battant avec vitrage fixe et imposte
 Turn/tilt window with fixed lights and top lights

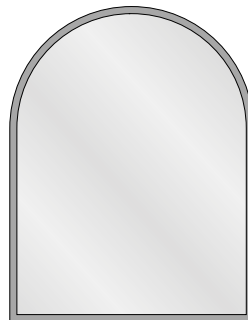

Festverglasung mit Rundbogen
 Vitrage fixe avec demi-rond
 Fixed lights with round arched

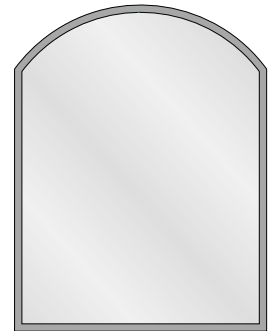
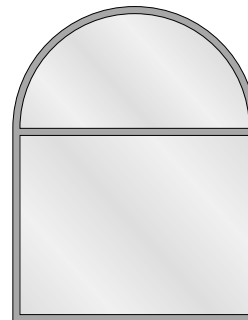

Profilübersicht
Sommaire des profilés
Summary of profiles

Janisol HI Fenster
 Janisol HI fenêtres
 Janisol HI windows

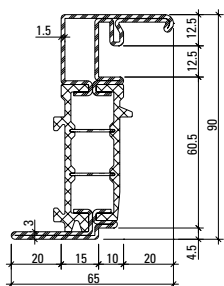

680.900 Z

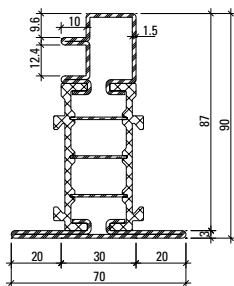

680.901 Z

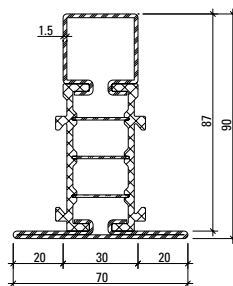

680.902 Z

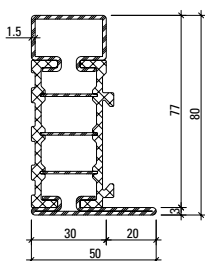

681.630 Z

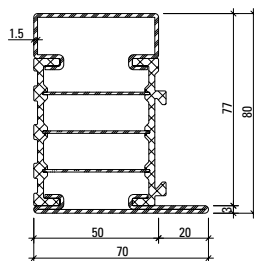

681.650 Z

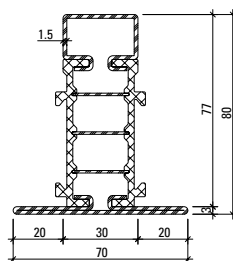

682.630 Z

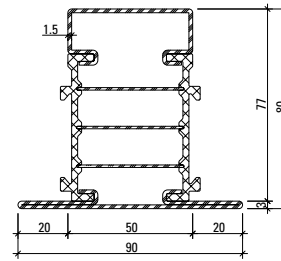

682.650 Z

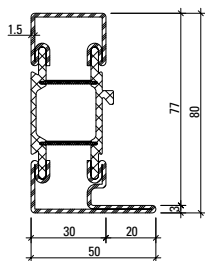

681.635 Z*

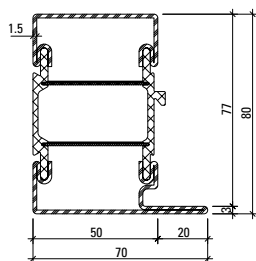

681.655 Z*

*in Kombination mit Bogen
 *en combinaison avec des cintres
 *in combination with arched design

Profil-Nr.	G kg/m	I _x cm ⁴	W _x cm ³	I _y cm ⁴	W _y cm ³	U m ² /m
681.630 Z	3,713	25,83	5,65	5,61	1,85	0,297
681.650 Z	4,331	32,30	7,21	15,97	4,04	0,337
682.630 Z	4,194	31,56	6,24	9,87	2,82	0,352
682.650 Z	4,816	38,99	7,94	24,03	5,34	0,392
680.900 Z	4,735					0,388
680.901 Z	4,618					0,390
680.902 Z	4,426	38,56	6,90	10,73	3,07	0,372
681.635 Z	3,784	26,93	5,71	7,49	2,42	0,310
681.655 Z	4,286	33,47	7,25	21,06	5,28	0,348

Artikelbibliothek
 Bibliothèque des articles
 Article library

DXF **DWG**

Profilübersicht
Sommaire des profilés
Summary of profiles

Janisol HI Fenster
 Janisol HI fenêtres
 Janisol HI windows

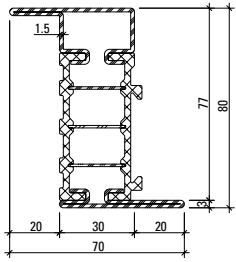

683.630 Z

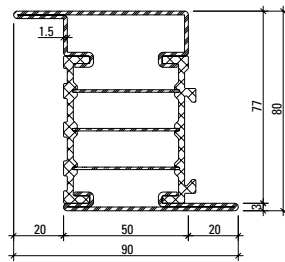

683.650 Z

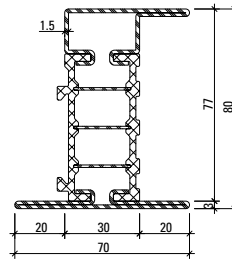

685.630 Z

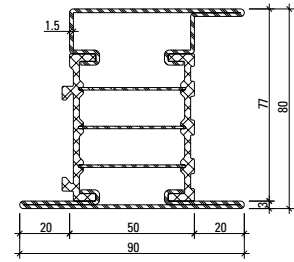

685.650 Z

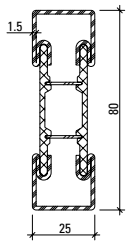

600.012
600.012 Z

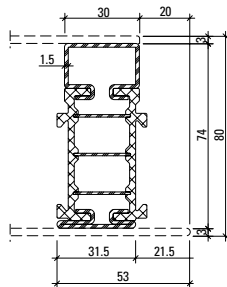

680.060 Z



Werkstoffe

Artikel-Nr.

ohne Zusatz = blank

mit Z = bandverzinkter Stahl

Isolator = glasfaserverstärkter Kunststoff

Matériaux

No. d'article

sans supplément = brut

avec Z = bande d'acier zinguée

Isolateur = matière plastique renforcé par fibres de verre

Materials

Part no.

without addition = bright

with Z = strip galvanised steel

Insulator = glassfibre reinforced plastic

Profil-Nr.	G kg/m	Ix cm ⁴	Wx cm ³	Iy cm ⁴	Wy cm ³	U m ² /m
683.630 Z	4,170	32,73	7,98	10,09	2,88	0,336
683.650 Z	4,787	38,93	9,50	24,43	5,42	0,376
685.630 Z	4,637	38,31	8,65	13,46	3,51	0,374
685.650 Z	5,258	47,62	10,93	30,13	6,14	0,415
600.012	3,254	19,67	4,92	2,93	2,34	0,224
680.060 Z	3,214	17,21	4,55	2,54	1,48	0,266

Bogenfenster
Fenêtres cintrées
Arched windows

Janisol HI Fenster
 Janisol HI fenêtres
 Janisol HI windows

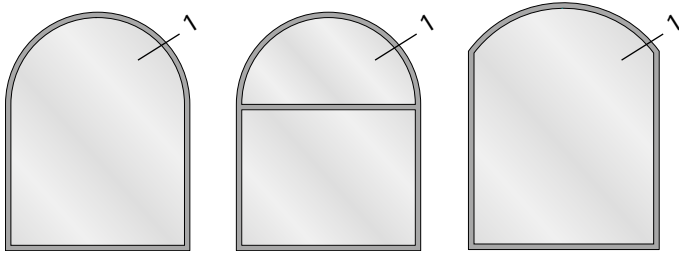

Stahl-Glasleisten	Min. Radius
Parcloses en acier	Rayon min.
Steel glazing beads	Min. radius
	R



402.112 Z	500 mm
402.115 Z	500 mm
402.120 Z	600 mm
402.125 Z	750 mm
402.130 Z	1000 mm
402.136 Z	500 mm
402.141 Z	500 mm

Stahl-Glasleisten	Min. Radius
Parcloses en acier	Rayon min.
Steel glazing beads	Min. radius
	R



62.507 Z	300 mm
62.508 Z	300 mm
62.509 Z	300 mm

Aluminium-Glasleisten	Min. Radius
Parcloses en aluminium	Rayon min.
Aluminium glazing beads	Min. radius
	R



404.112	400 mm
404.115	400 mm
404.120	400 mm
404.125	450 mm
404.130	500 mm
404.135	600 mm

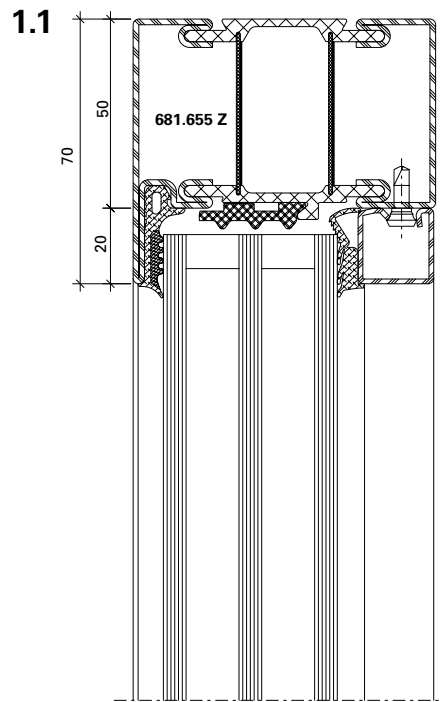
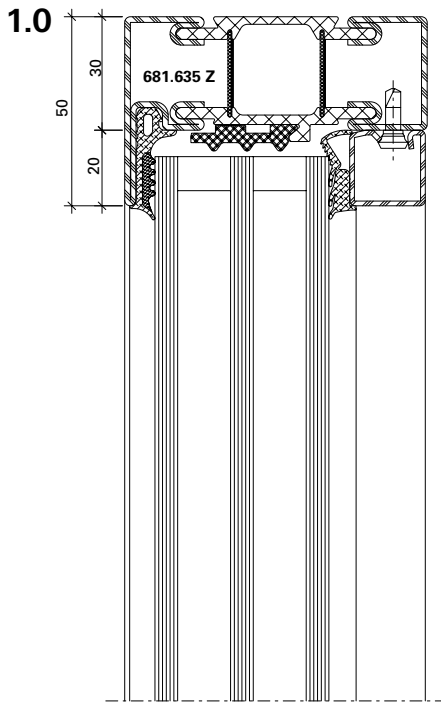

Profil	Min. Radius
Profilé	Rayon min.
Profile	Min. radius
	R

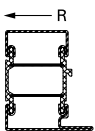

681.635 Z	700 mm
681.655 Z	750 mm

Andere Profiltypen sowie im Grundriss gebogene Profile auf Anfrage.

Autres types de profilés et profilés au tracé cintré sur demande.

Other profile types and profiles curved in the floor plan are available on request.

Die Radien-Angaben beziehen sich auf die Fertigung im Hause Jansen.

Les rayons indiqués concernent la fabrication des cintres par la société Jansen.

The radius information refers to the production of the arches at the Jansen.

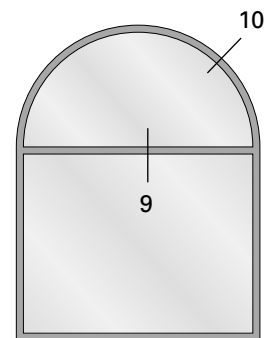
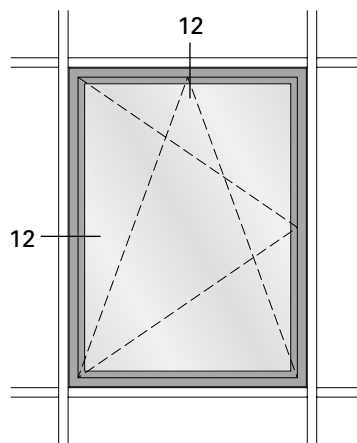
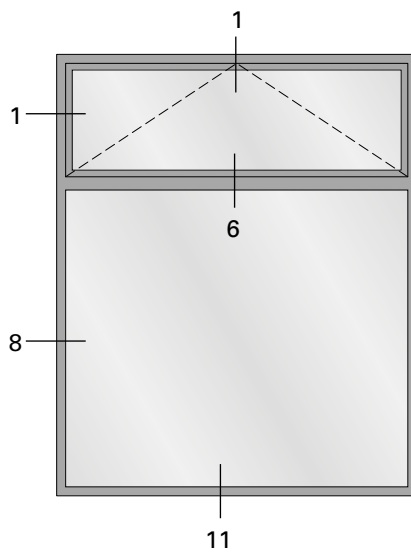
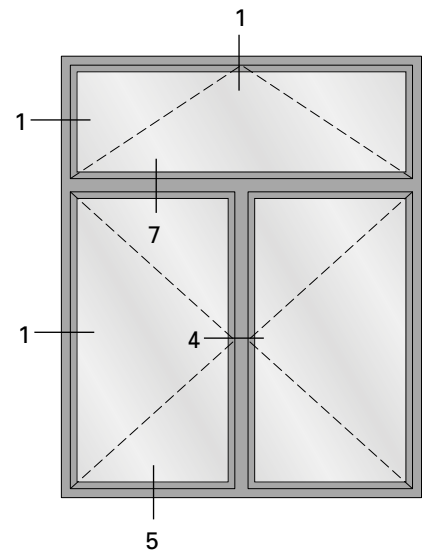
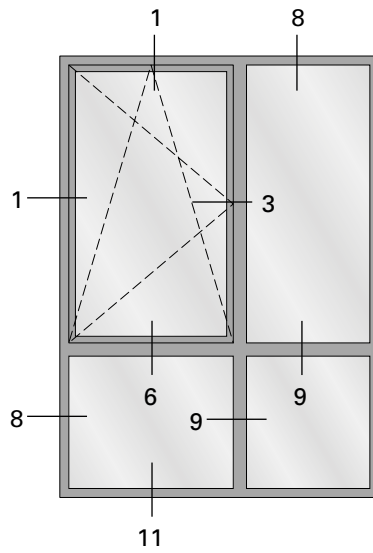
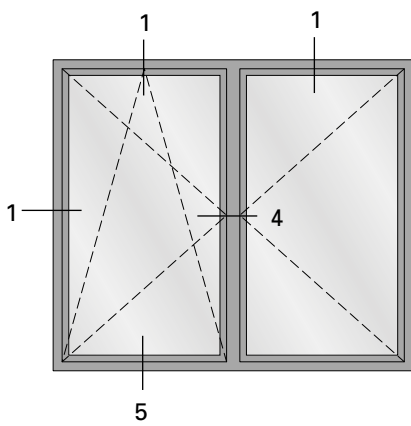
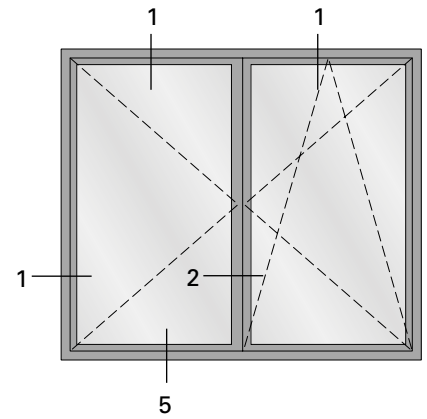
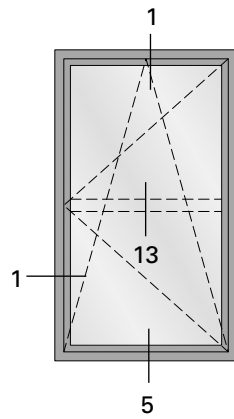
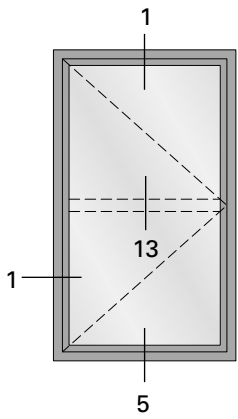

1.0

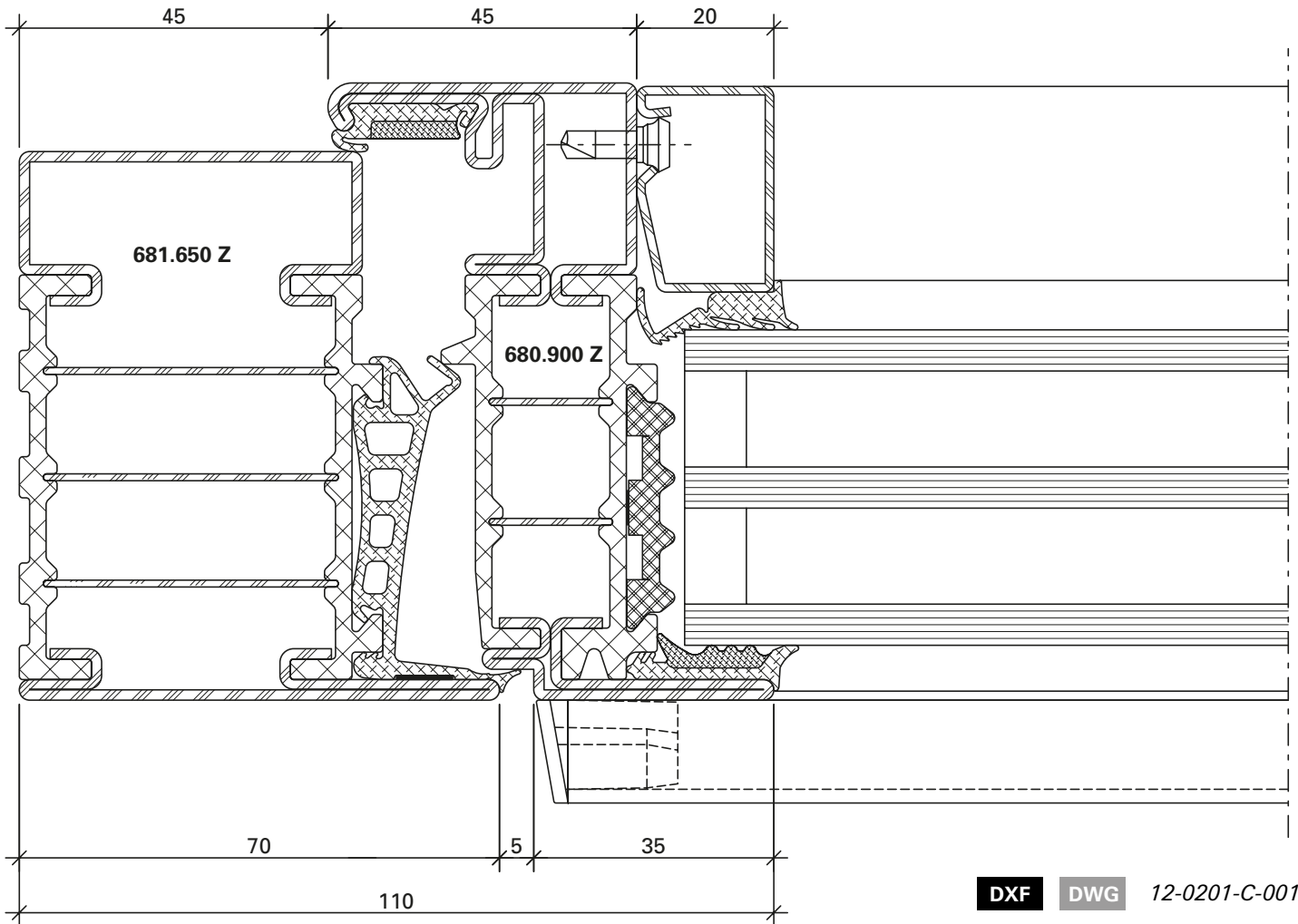

DXF

DWG

12-0201-C-001

1.1

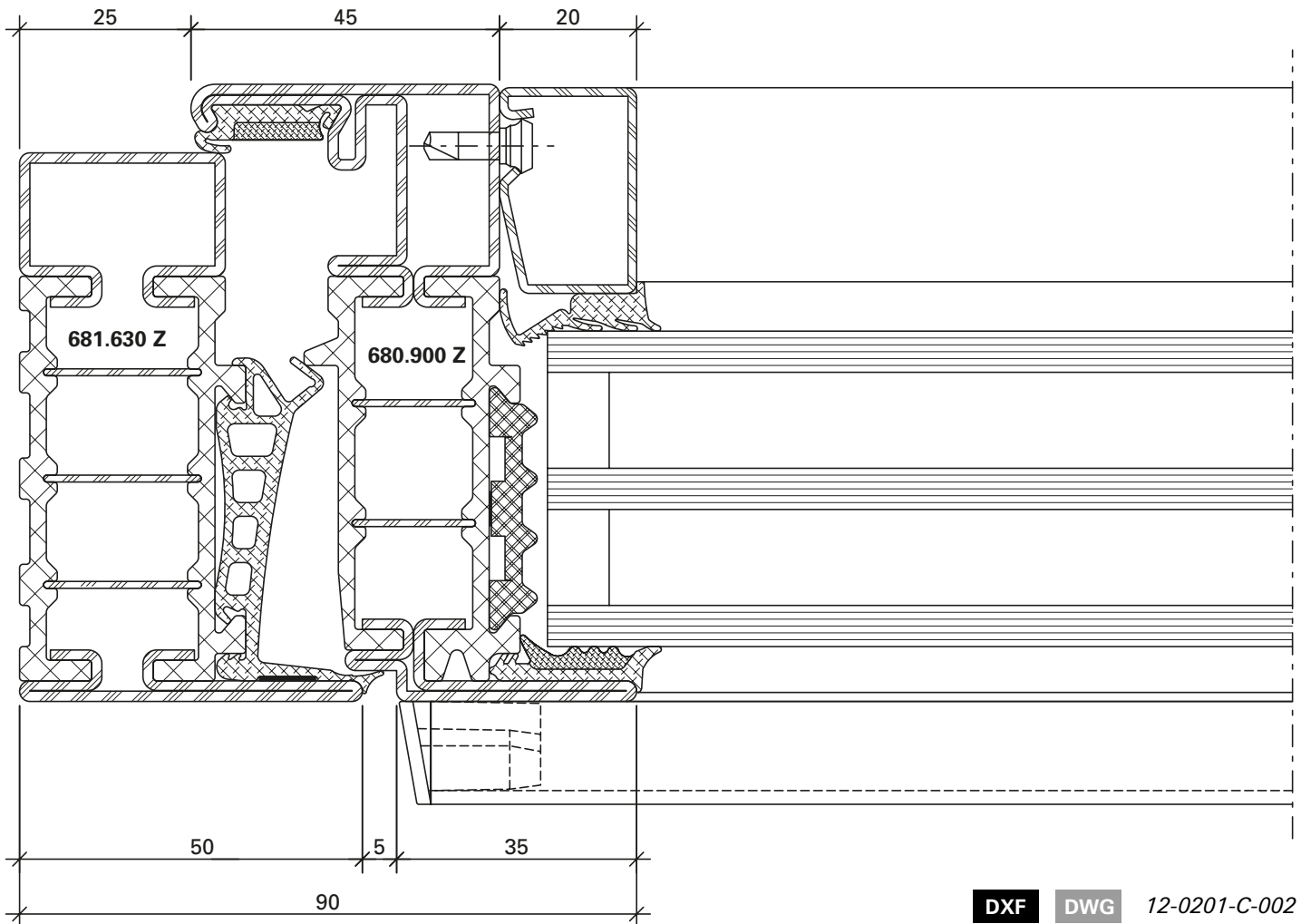

DXF

DWG

12-0201-C-002

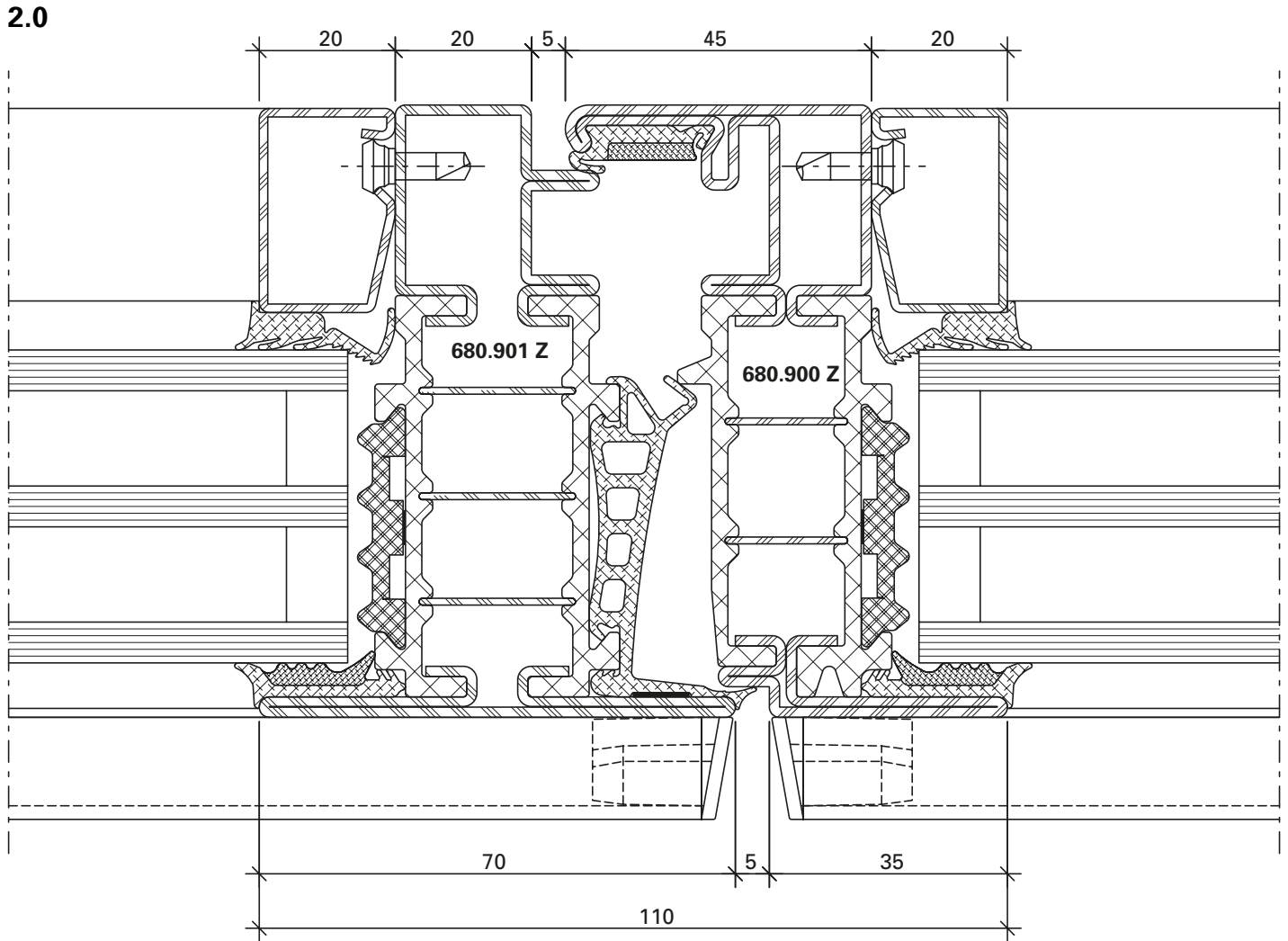

DXF DWG 12-0201-C-007

3.0

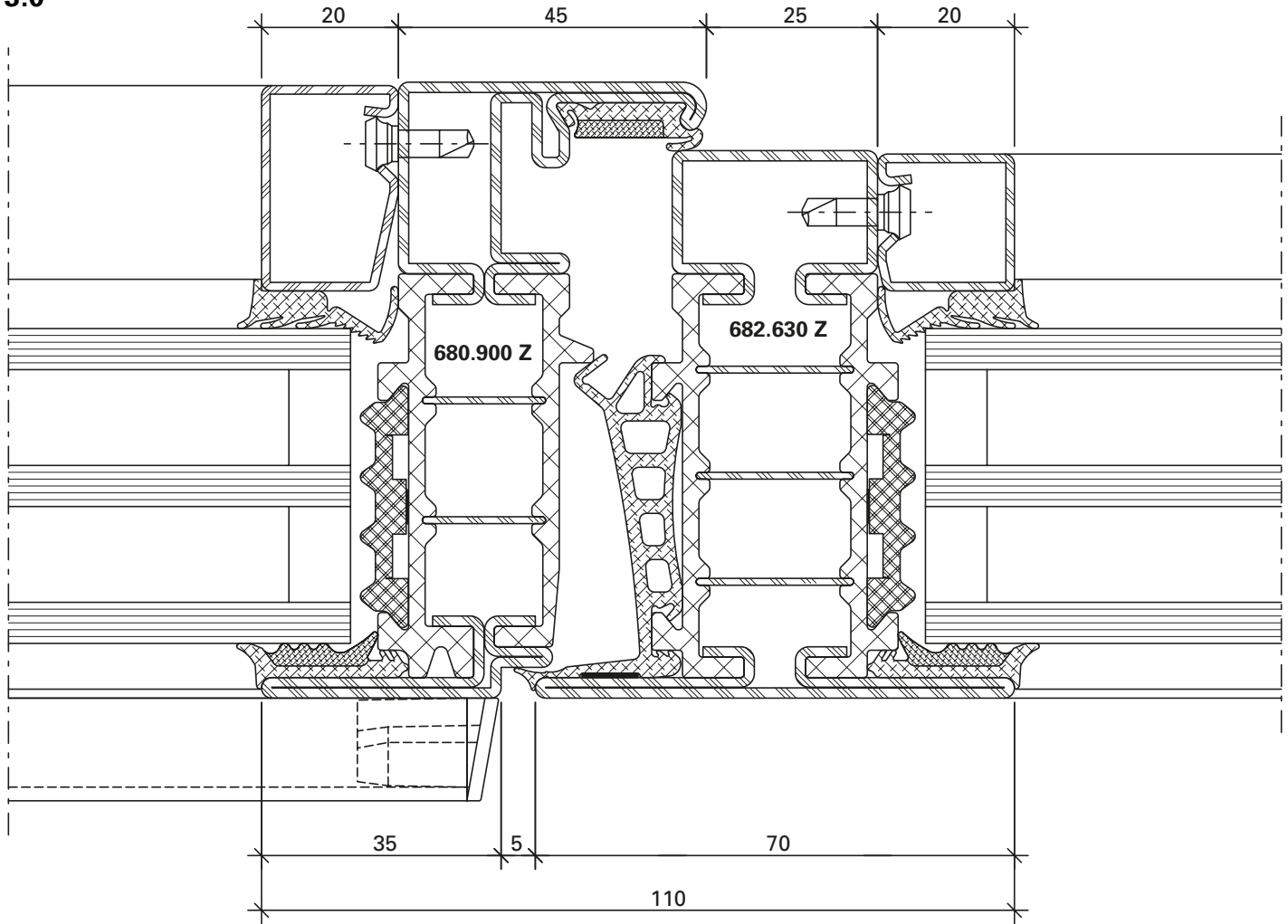

DXF DWG 12-0201-C-004

4.0

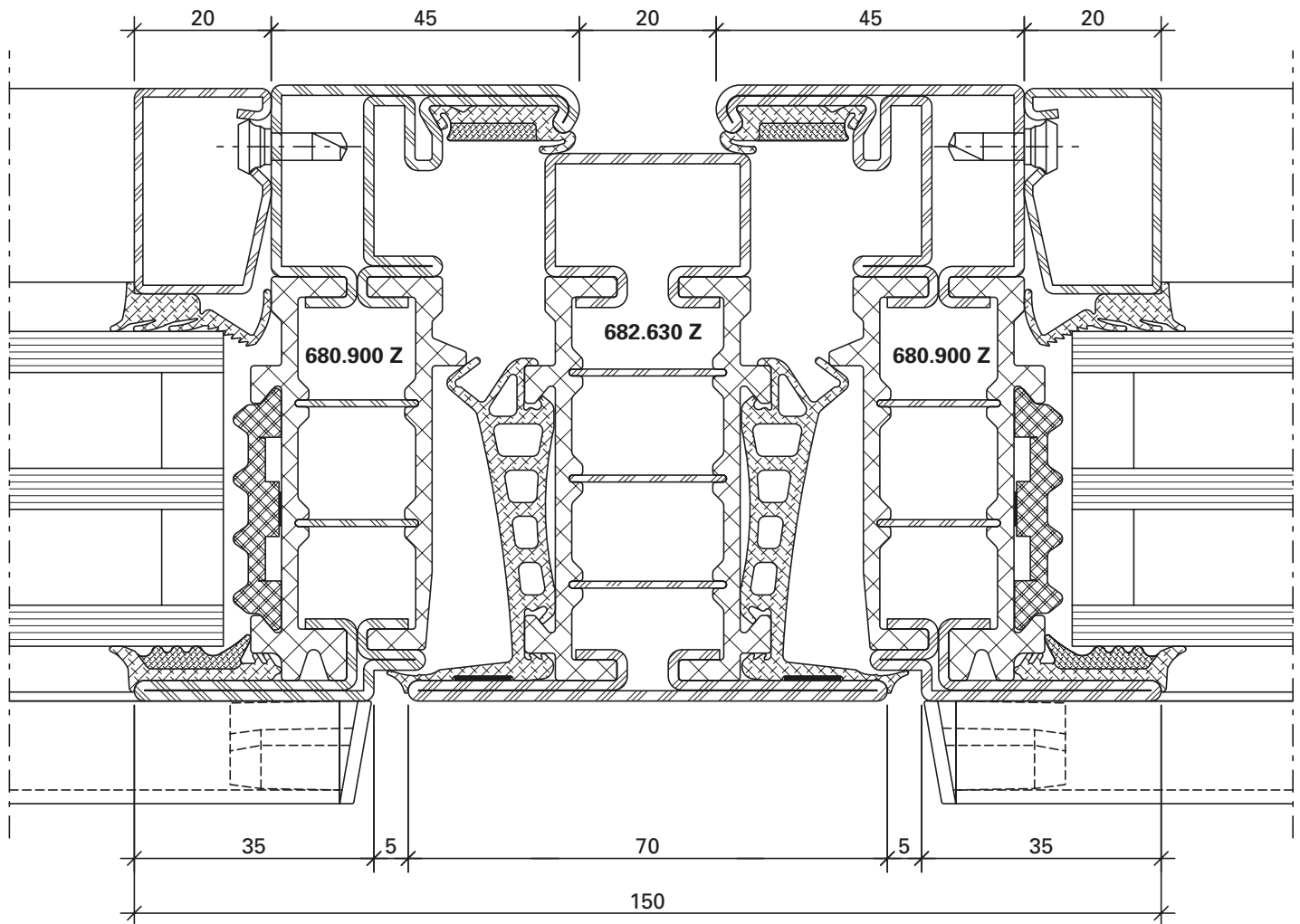

DXF DWG 12-0201-C-006

13.0

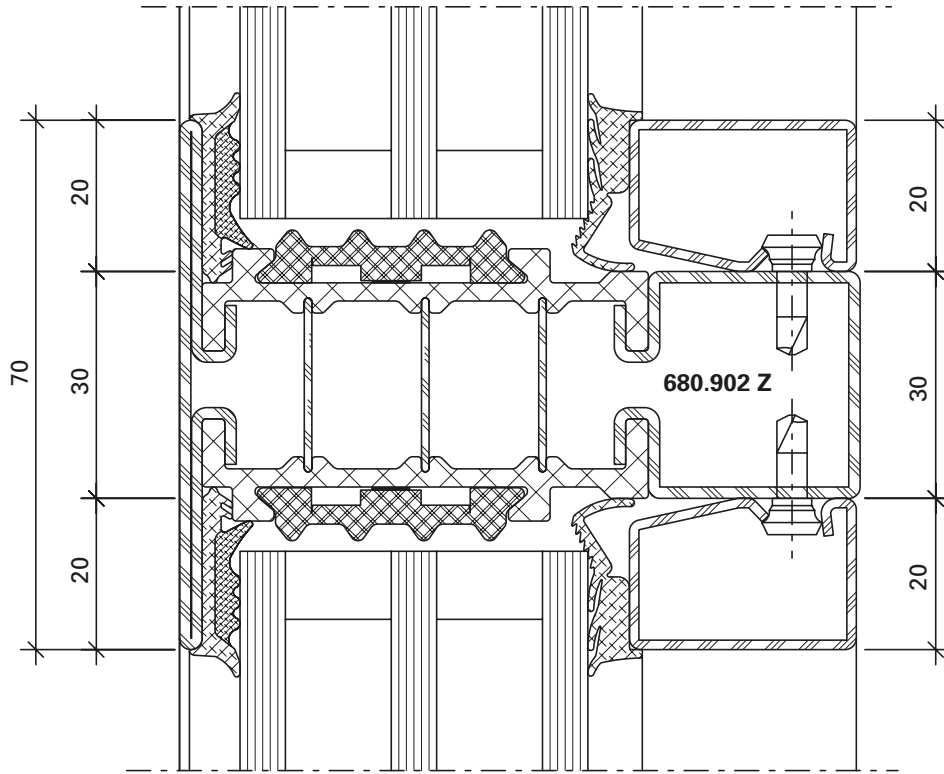

12-0201-C-020

DWG

DXF

5.0

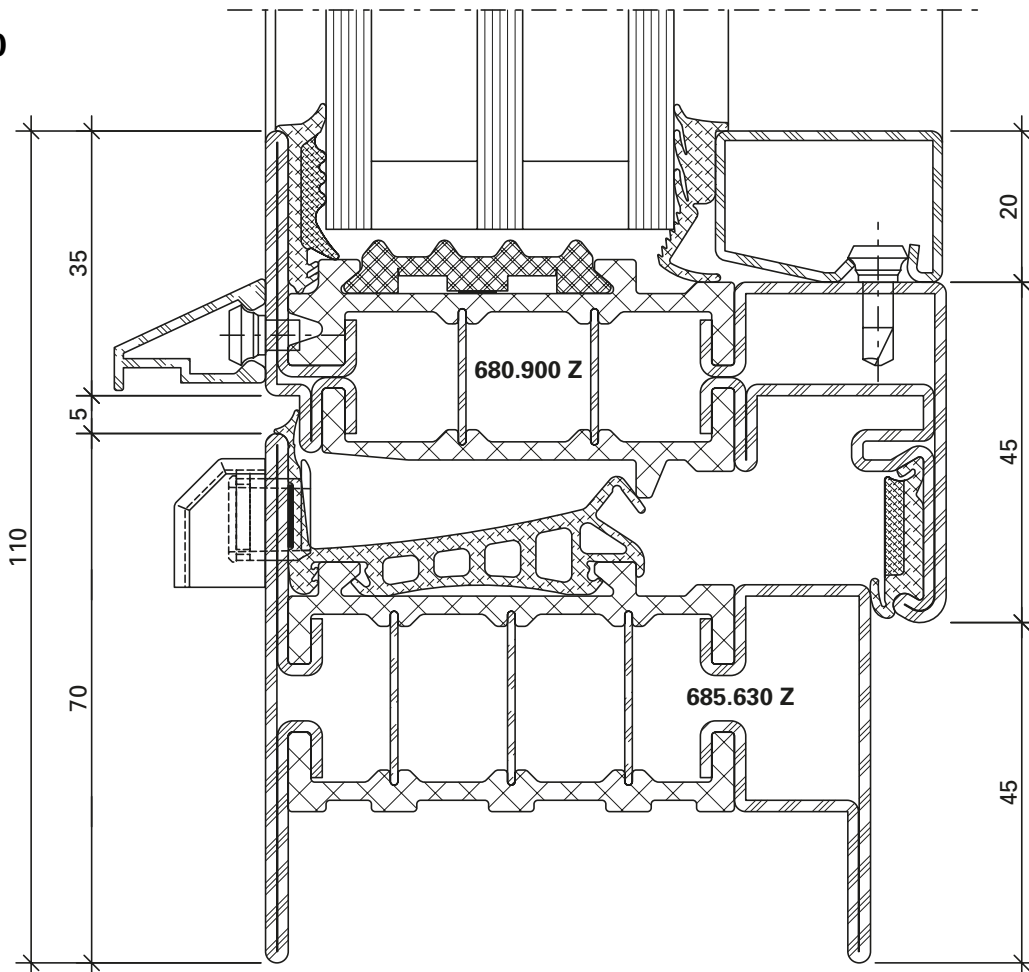

12-0201-C-009

DWG

DXF

6.0

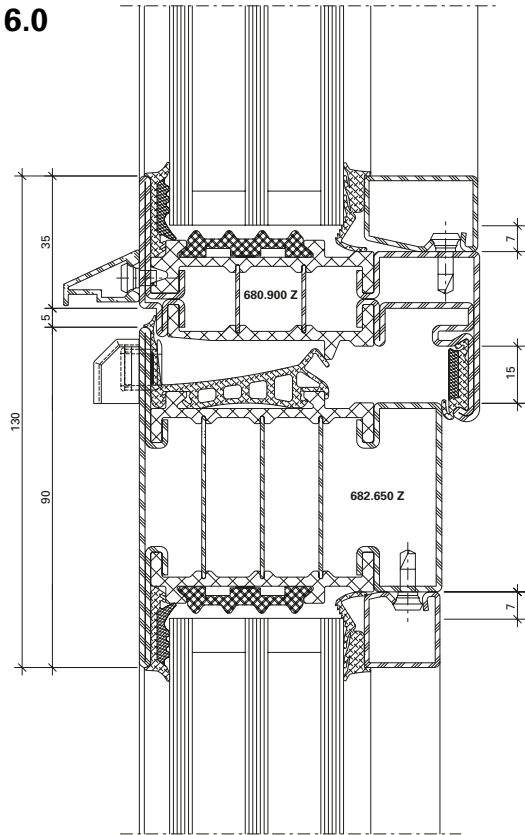

DWG 12-0201-C-016

DWG

DXF

6.1

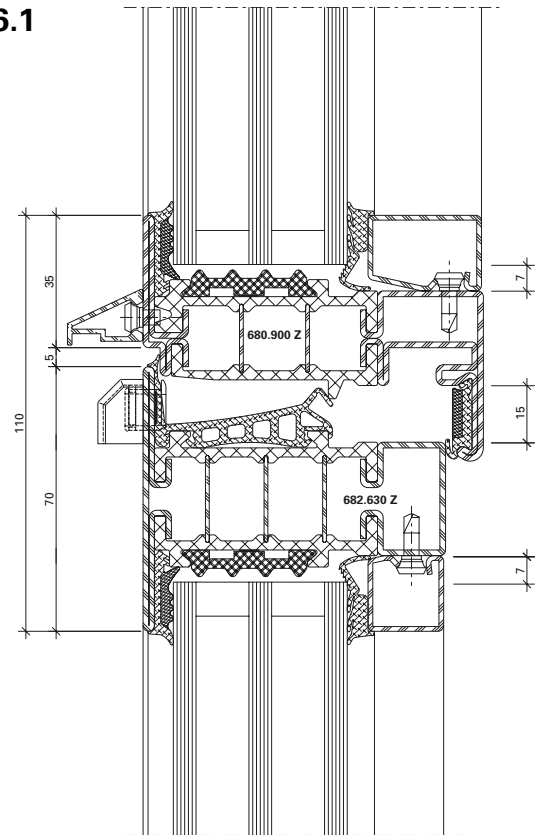

DWG 12-0201-C-019

DWG

DXF

7.0

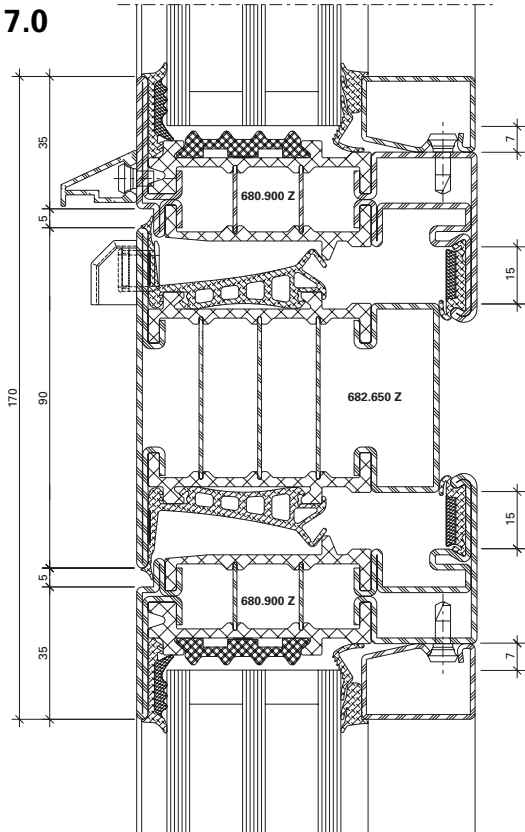

DWG 12-0201-C-018

DWG

DXF

5.1

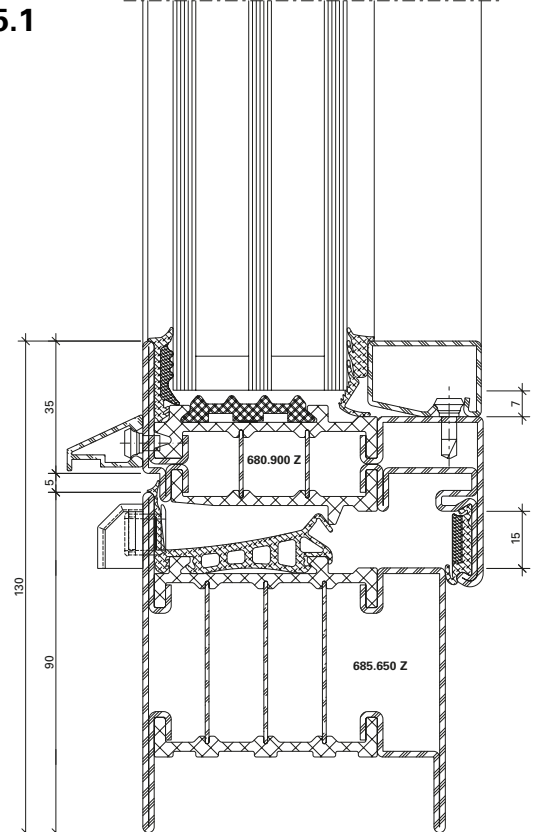

DWG 12-0201-C-008

DWG

DXF

8.0

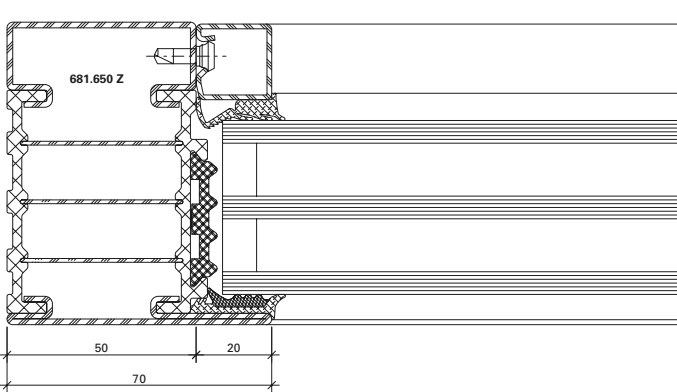

DXF

DWG

12-0201-C-012

9.0

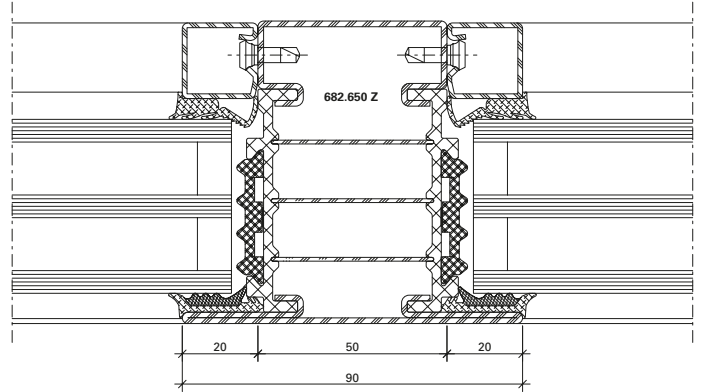

DXF

DWG

12-0201-C-014

8.1

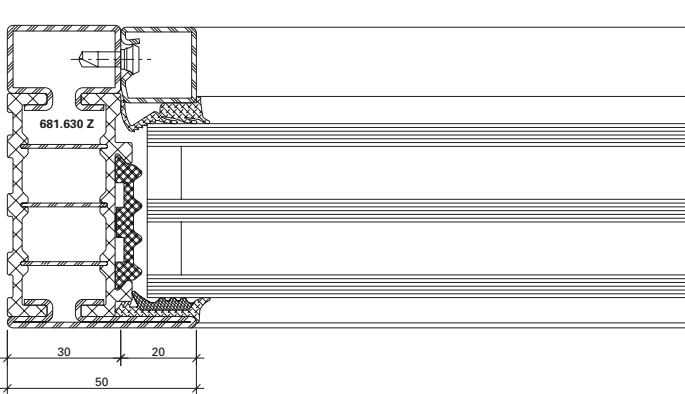

DXF

DWG

12-0201-C-013

9.1

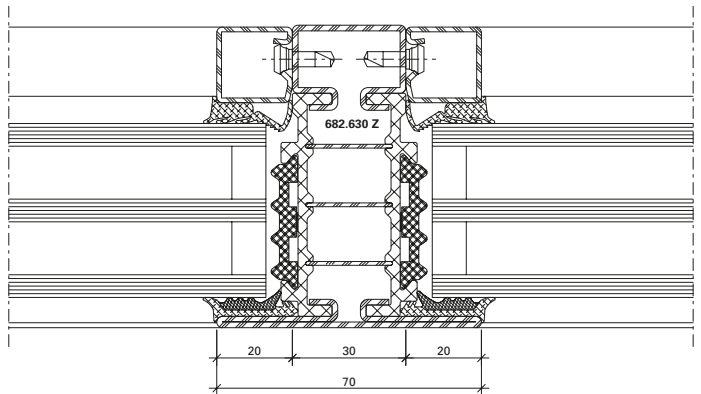

DXF

DWG

12-0201-C-015

10.0

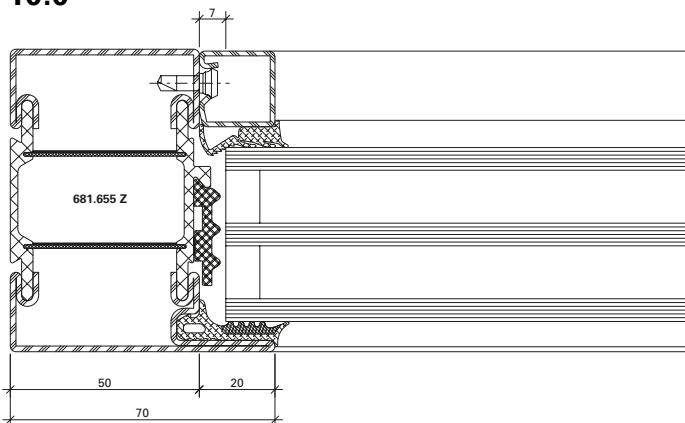

DXF

DWG

12-0204-C-003

10.1

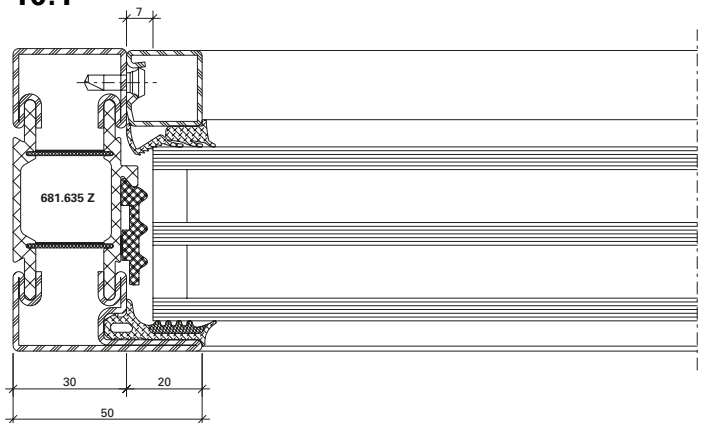

DXF

DWG

12-0204-C-004

3.1

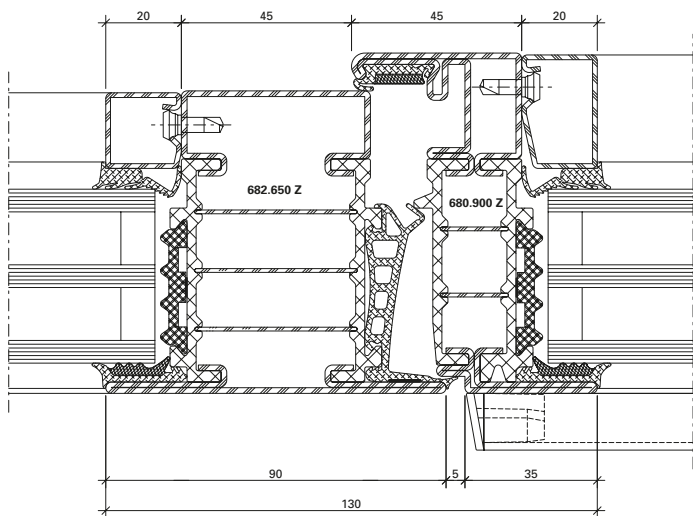

DXF **DWG** 12-0201-C-003

4.1

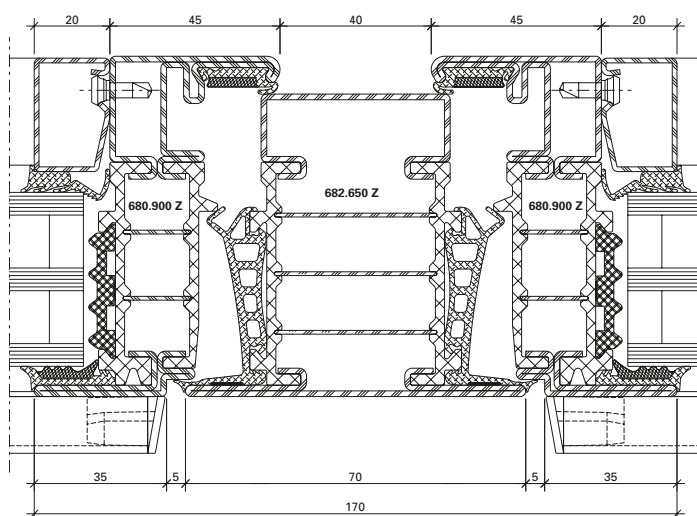

DXF **DWG** 12-0201-C-005

1.3

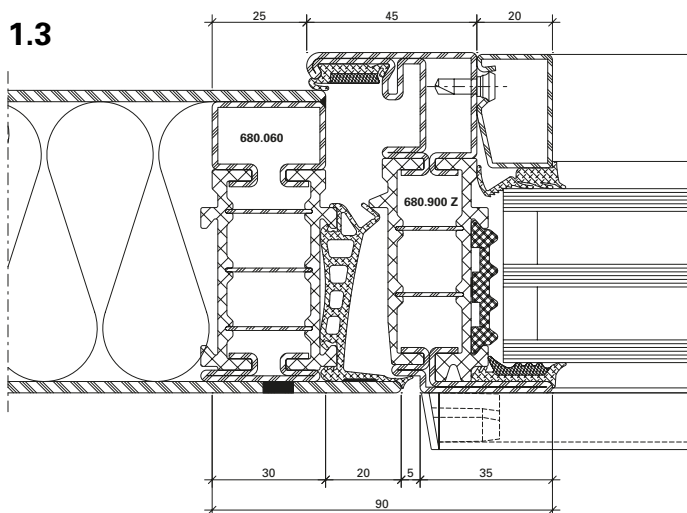

DXF **DWG** 12-0201-C-021

8.2

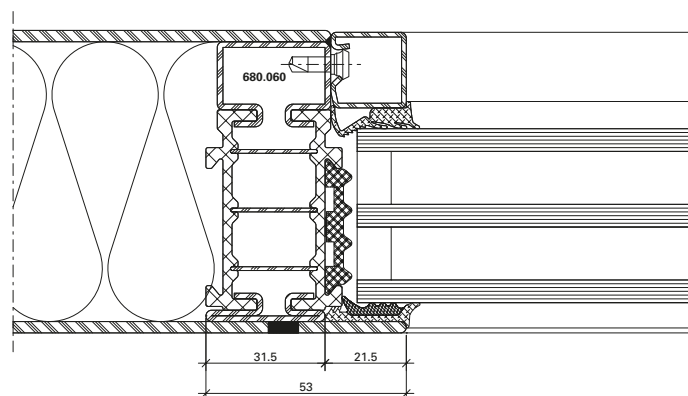

DXF **DWG** 12-0201-C-022

9.2

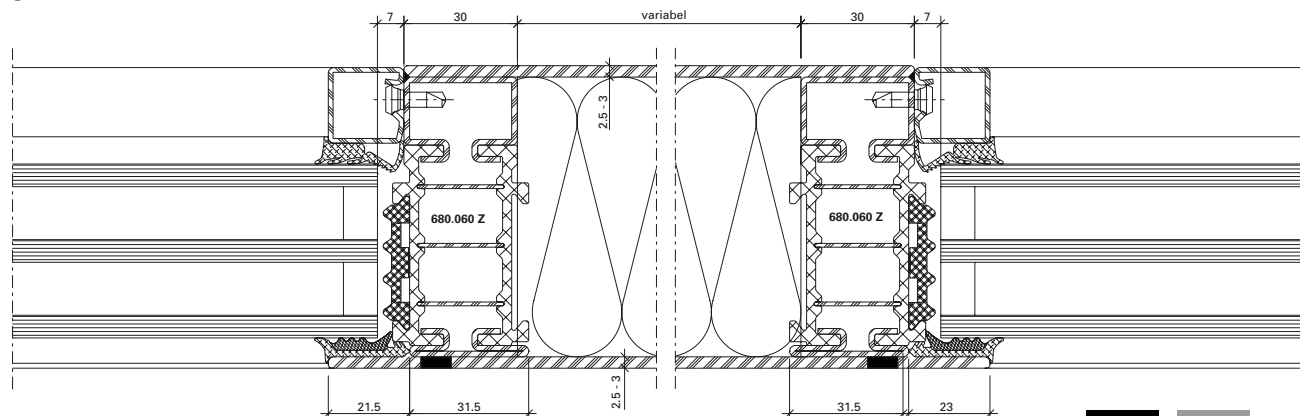

DXF **DWG** 12-0102-C-065

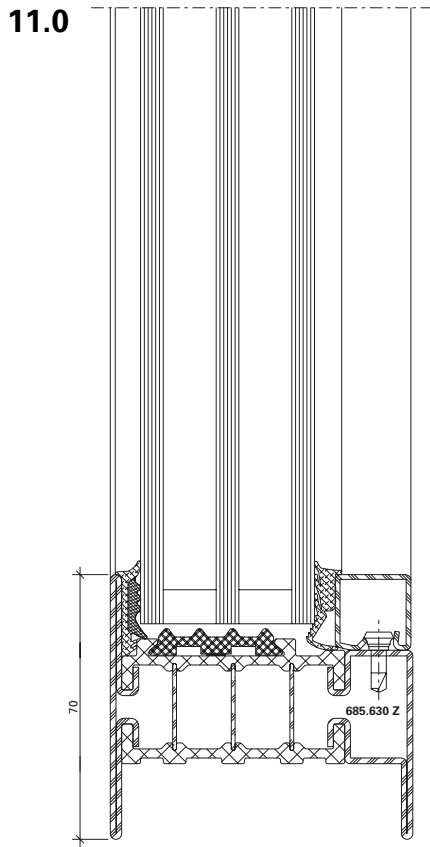

12-0201-C-011

DWG

DXF

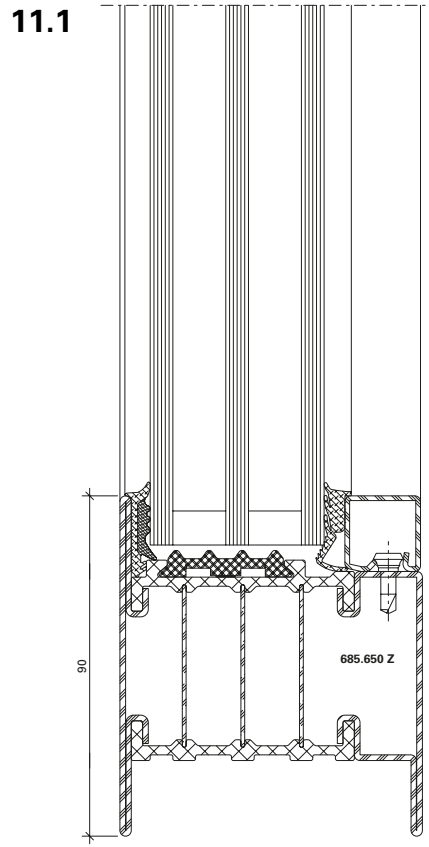

12-0201-C-010

DWG

DXF

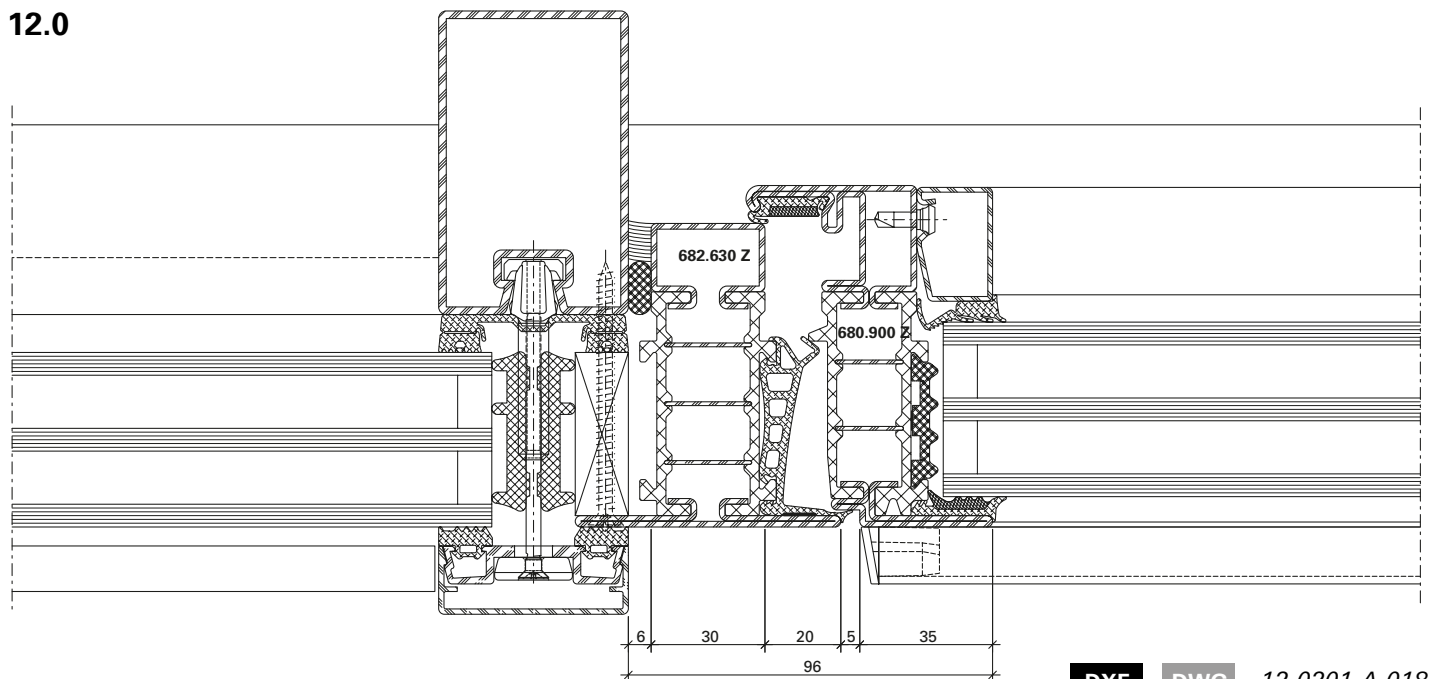

DXF

DWG

12-0201-A-018

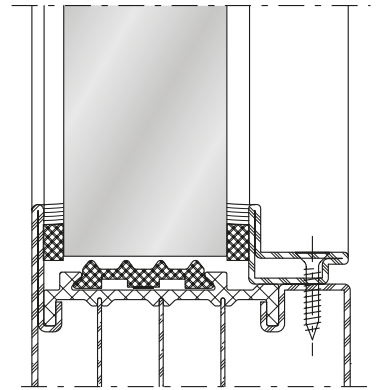
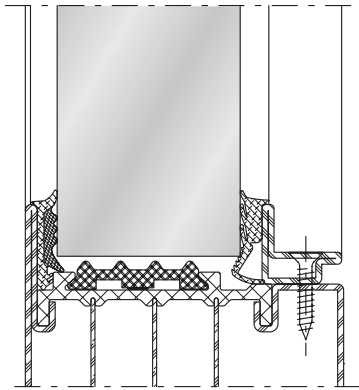
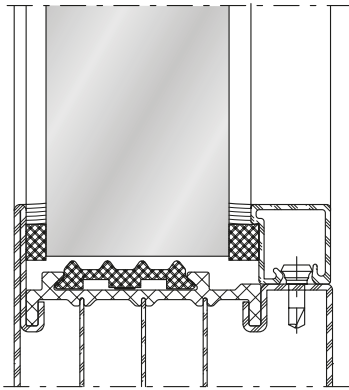
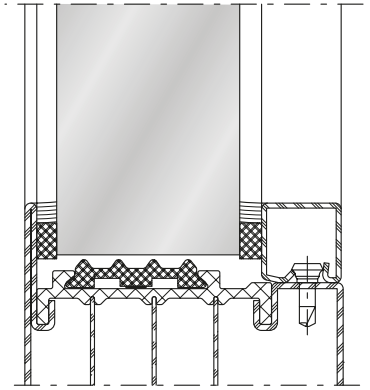
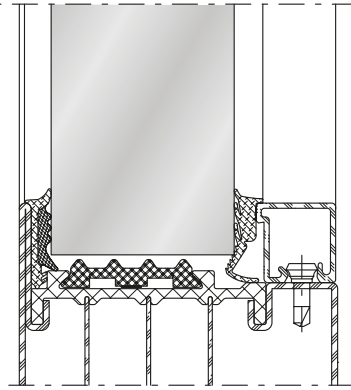
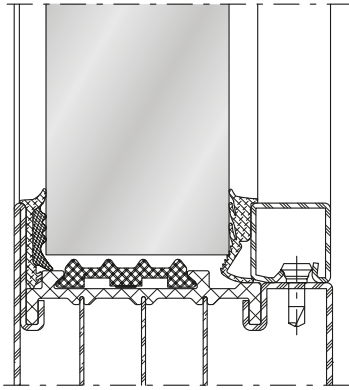

Platzbedarf
Standard-Fensterbeschlag
Bei Öffnungswinkel 90°

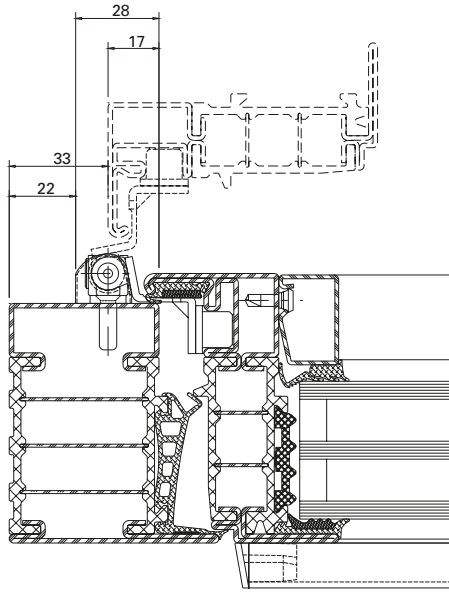

Espace nécessaire
Ferrure de fenêtre standard
À l'angle d'ouverture 90°

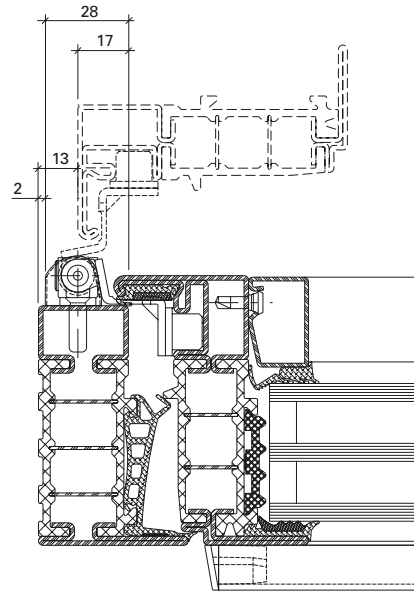

Space required
Standard window fitting
At opening angle 90°

Platzbedarf
Verdeckt liegender Fensterbeschlag
Bei Öffnungswinkel 90°

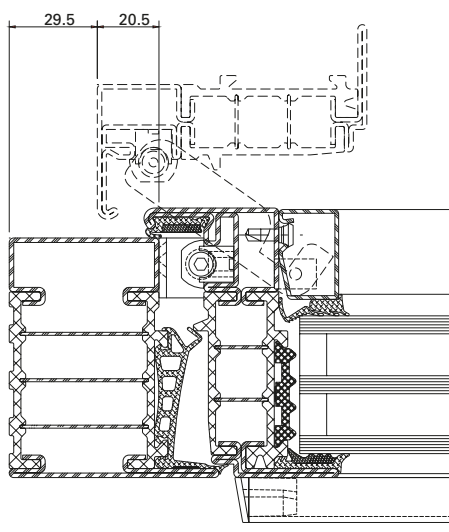

Espace nécessaire
Ferrure de fenêtre non apparente
À l'angle d'ouverture 90°

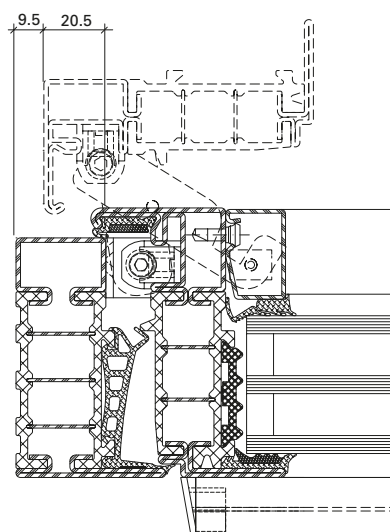

Space required
Concealed window fitting
At opening angle 90°

Platzbedarf
Standard-Fensterbeschlag
Bei Öffnungswinkel 90°

Espace nécessaire
Ferrure de fenêtre standard
À l'angle d'ouverture 90°

Space required
Standard window fitting
At opening angle 90°

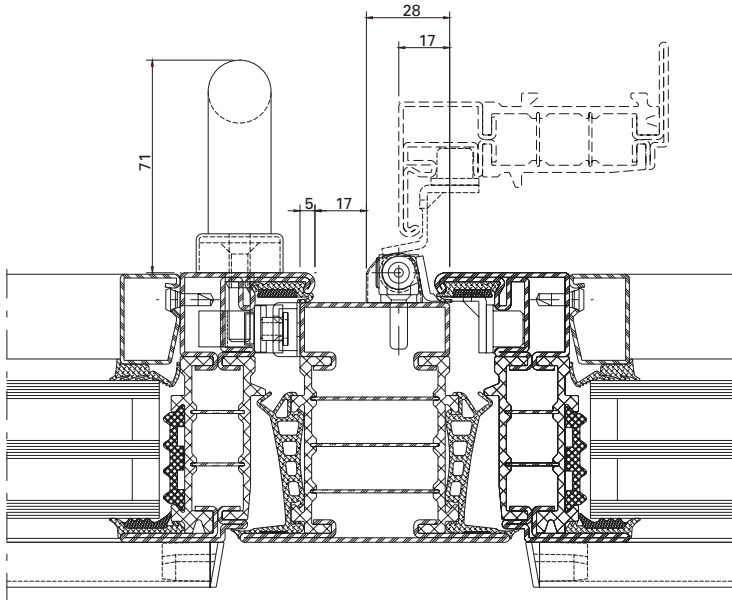

Platzbedarf
Verdeckt liegender Fensterbeschlag
Bei Öffnungswinkel 90°

Espace nécessaire
Ferrure de fenêtre non apparente
À l'angle d'ouverture 90°

Space required
Concealed window fitting
At opening angle 90°

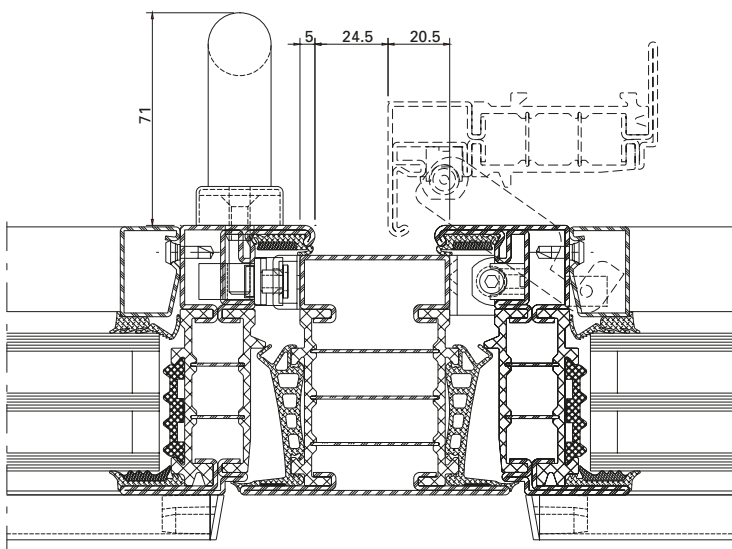

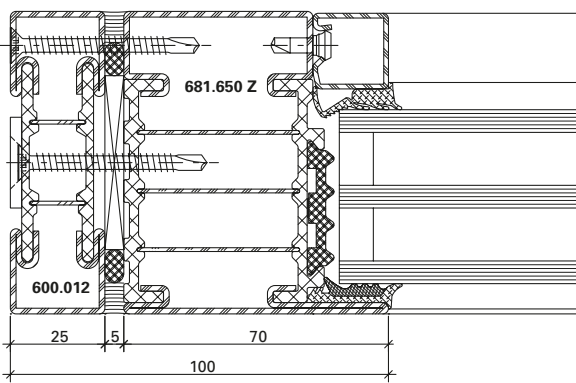

DXF **DWG** 12-0201-K-001

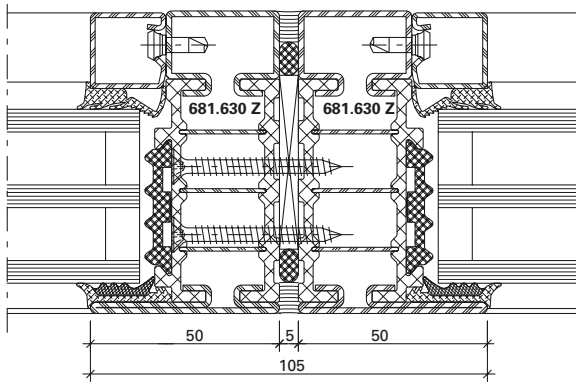

DXF **DWG** 12-0201-K-002

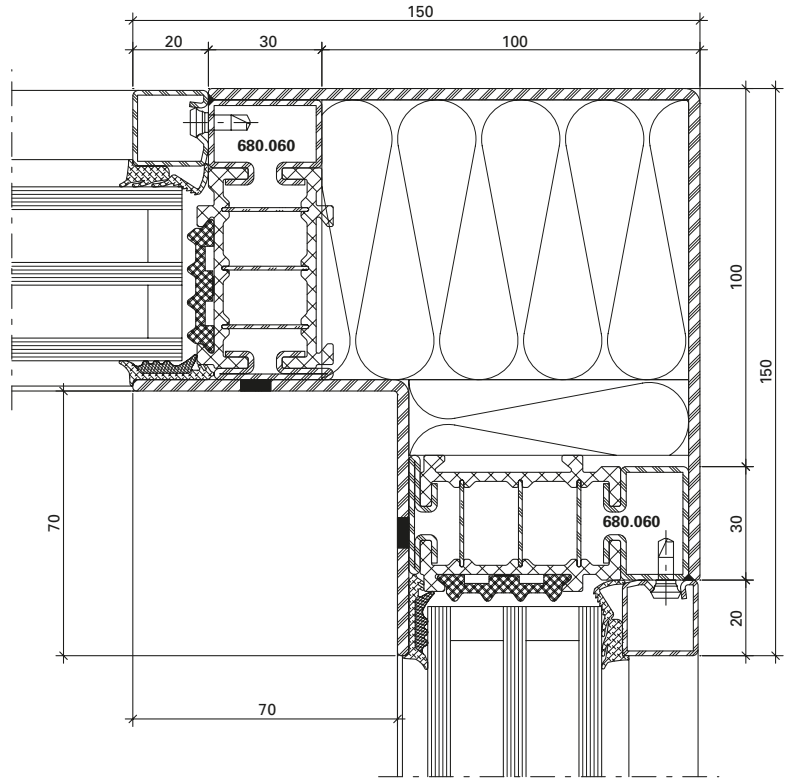

DXF **DWG** 12-0201-K-005

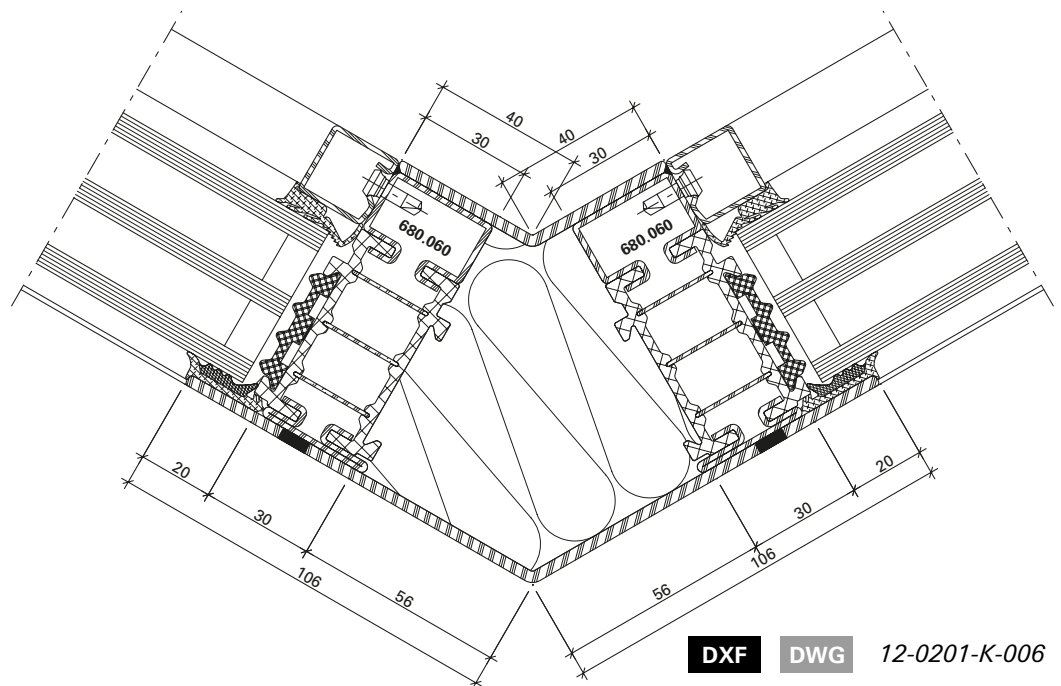

DXF **DWG** 12-0201-K-006

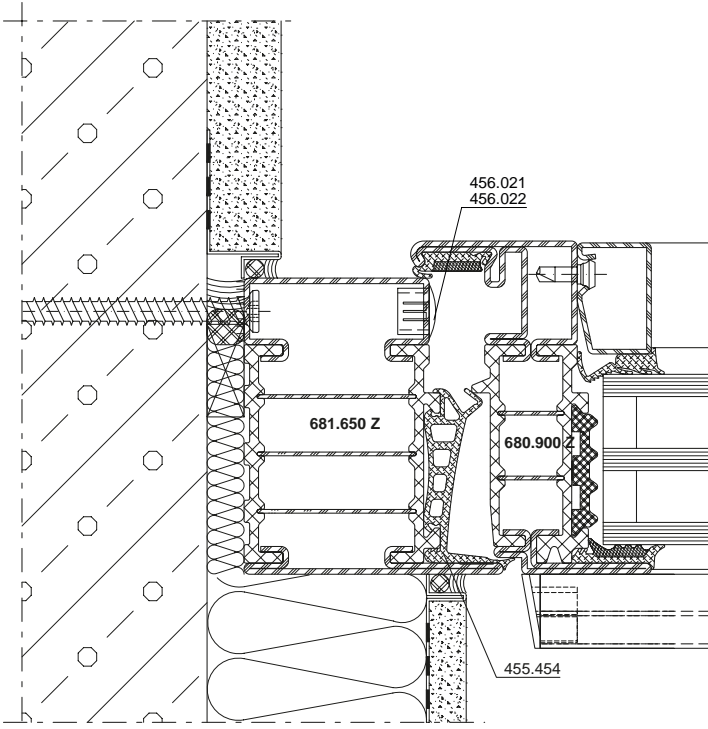

DXF **DWG** 12-0201-A-037

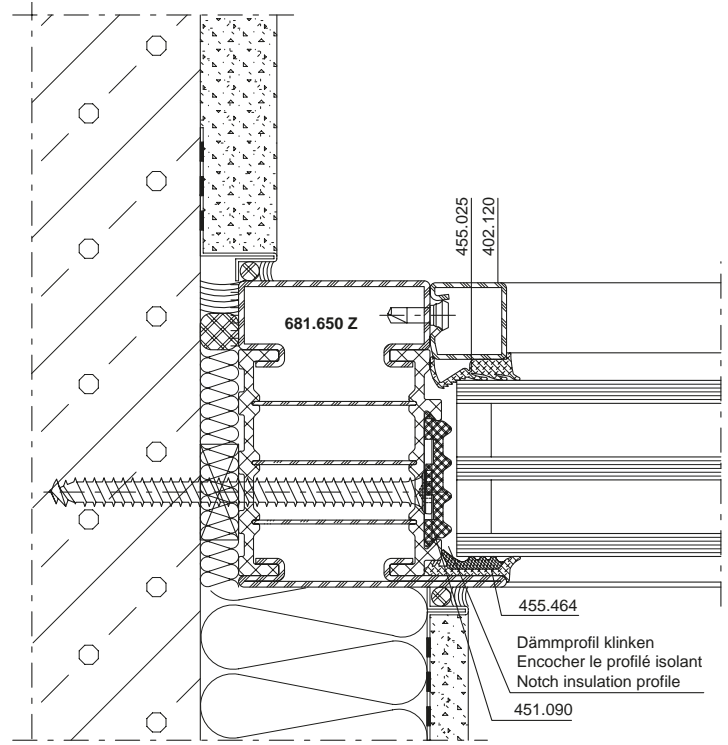

DXF **DWG** 12-0201-A-038

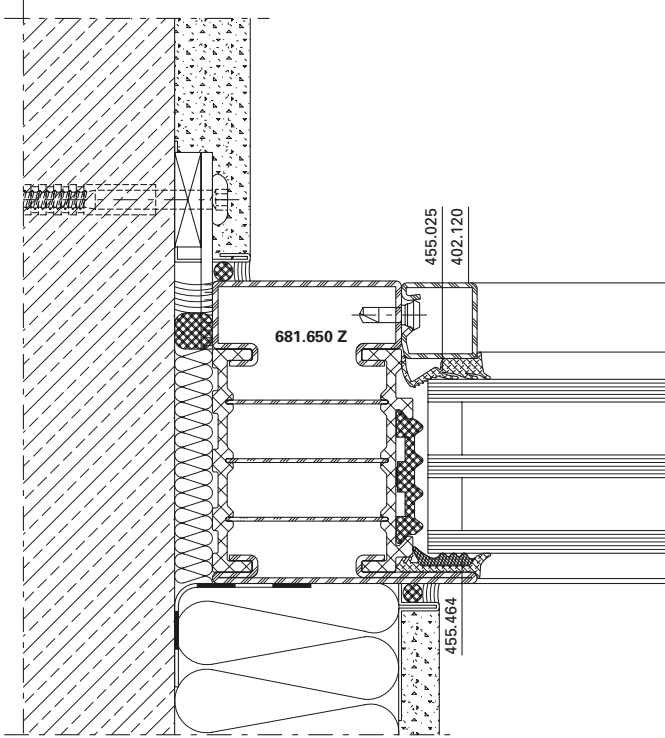

DXF **DWG** 12-0201-A-002

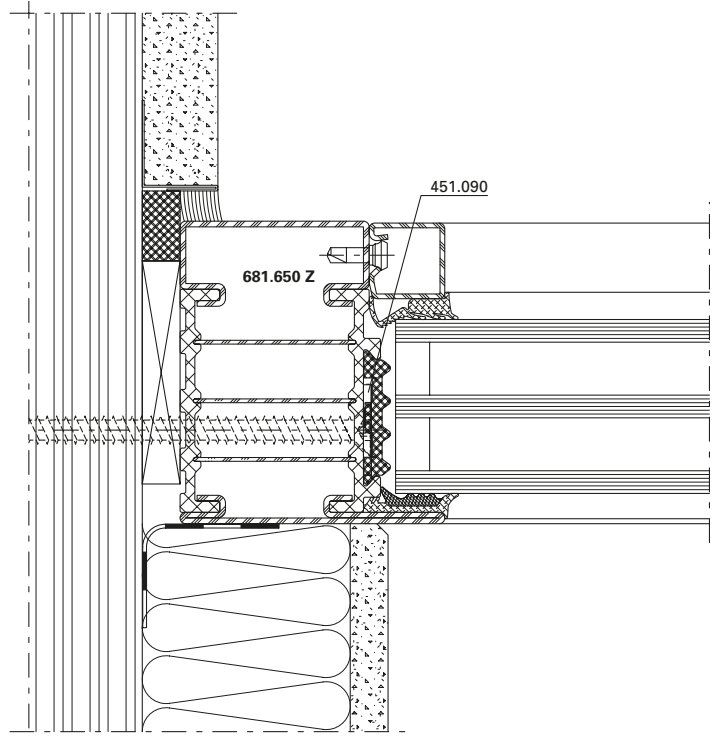

DXF **DWG** 12-0201-A-016

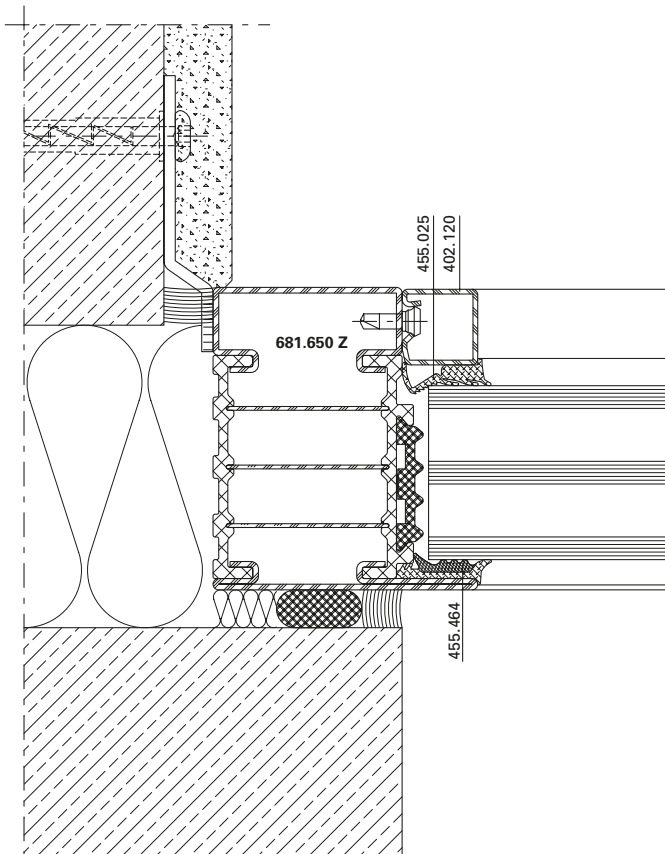

DXF **DWG** 12-0201-A-004

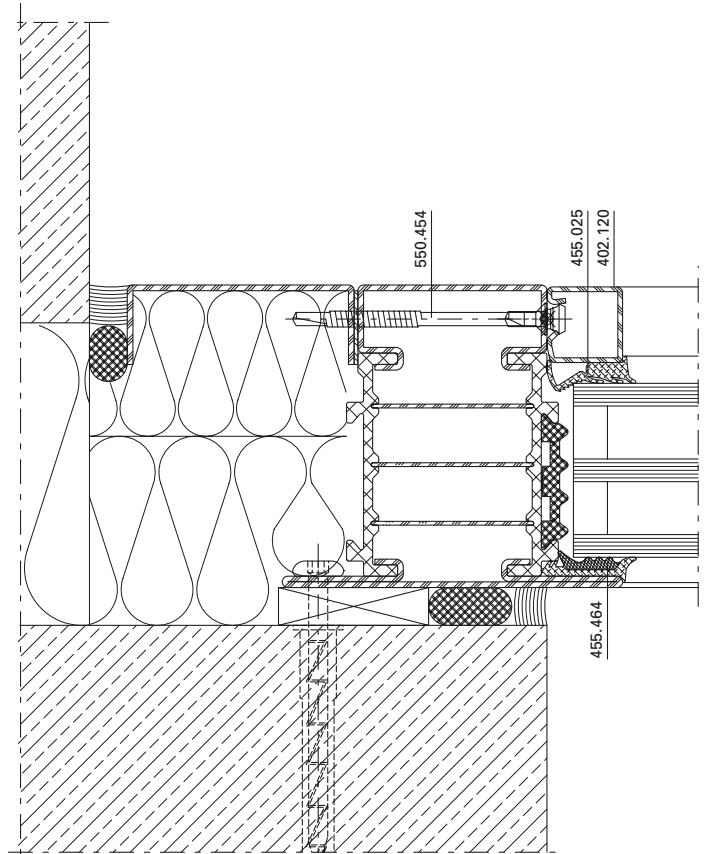

DXF **DWG** 12-0201-A-005

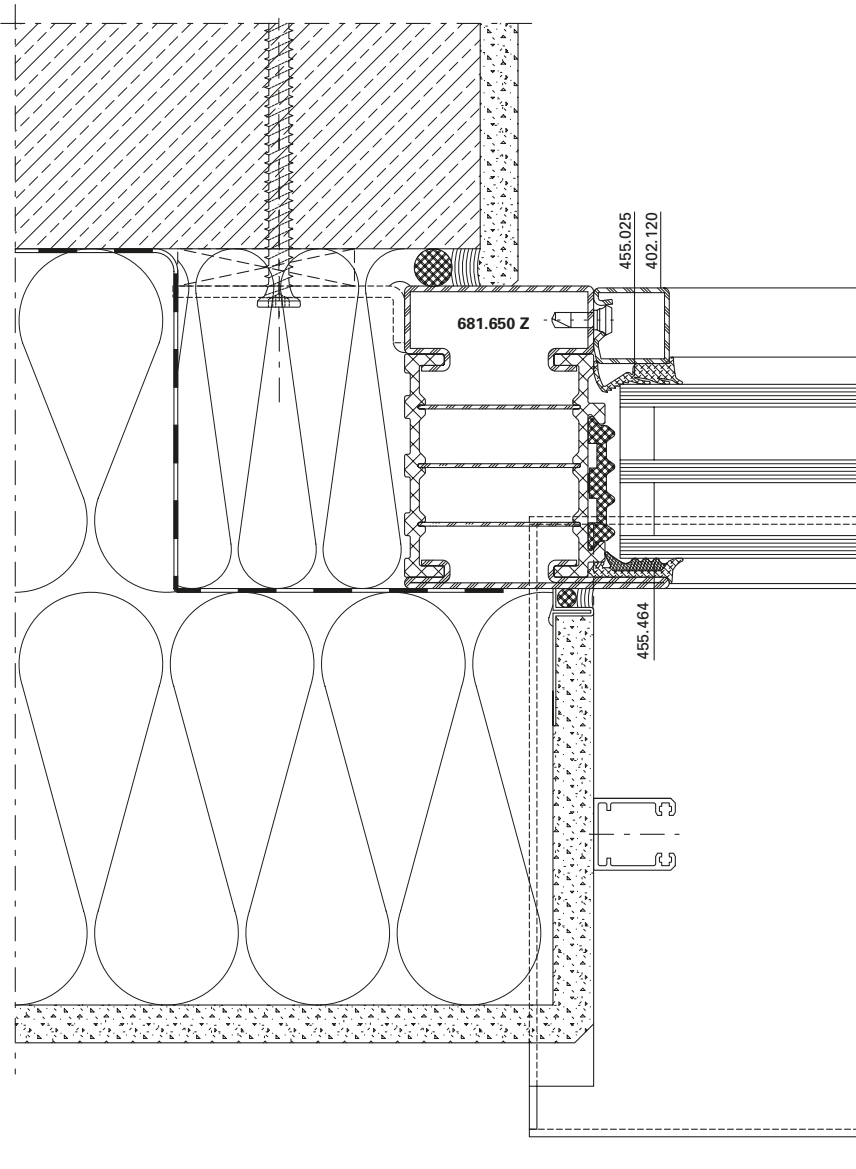

DXF **DWG** 12-0201-A-001

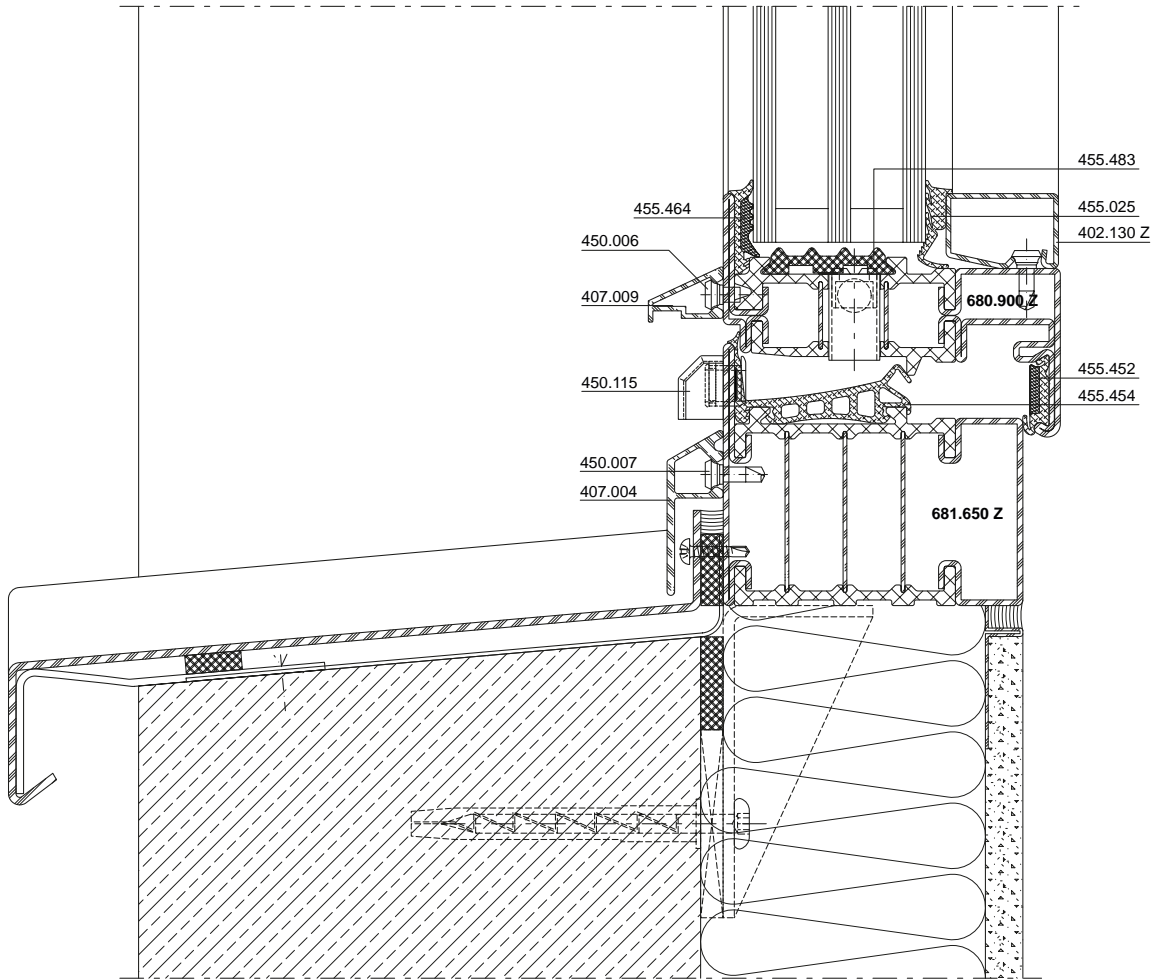

DXF

DWG

12-0201-A-014

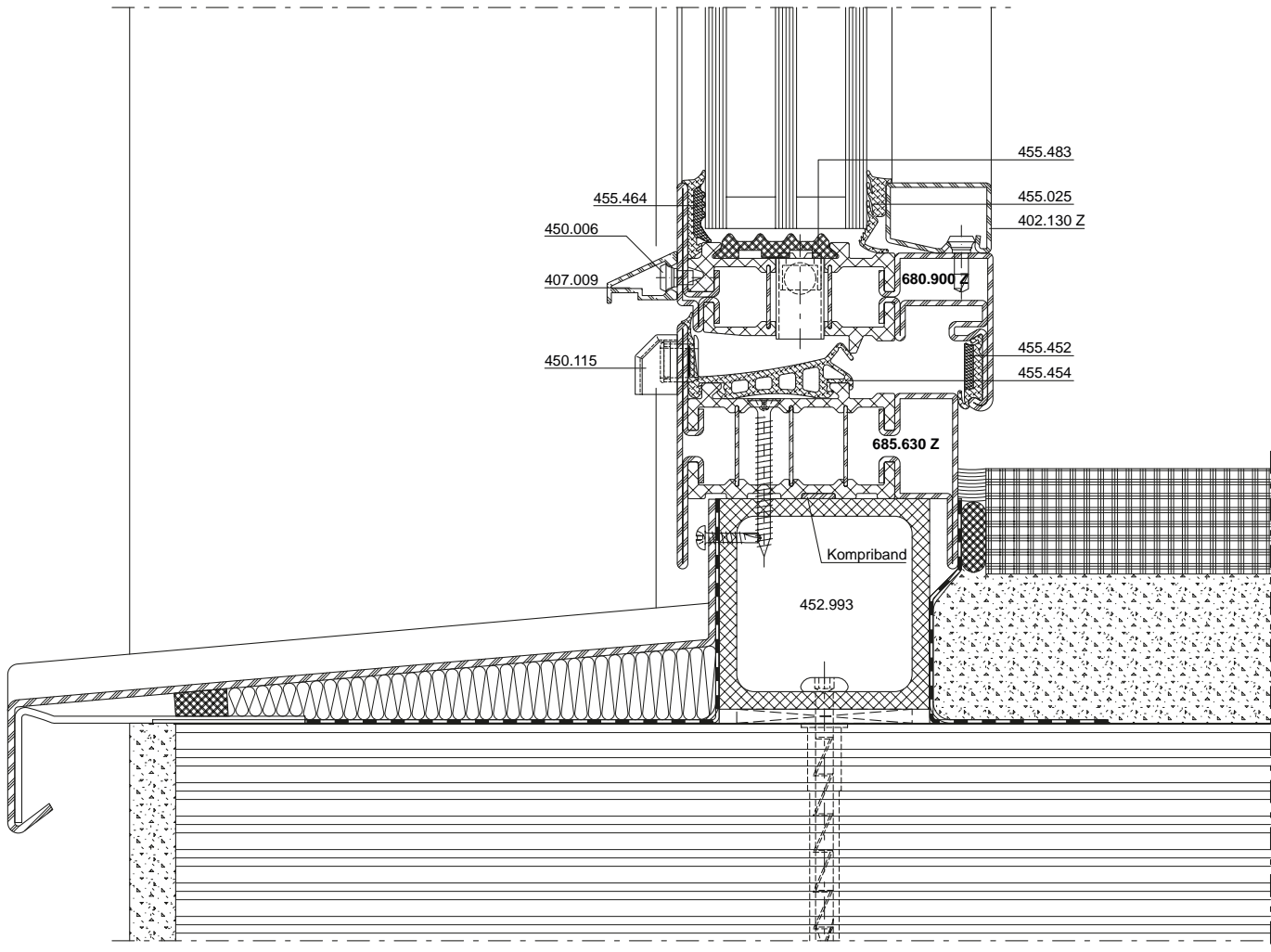

DXF DWG 12-0201-A-015

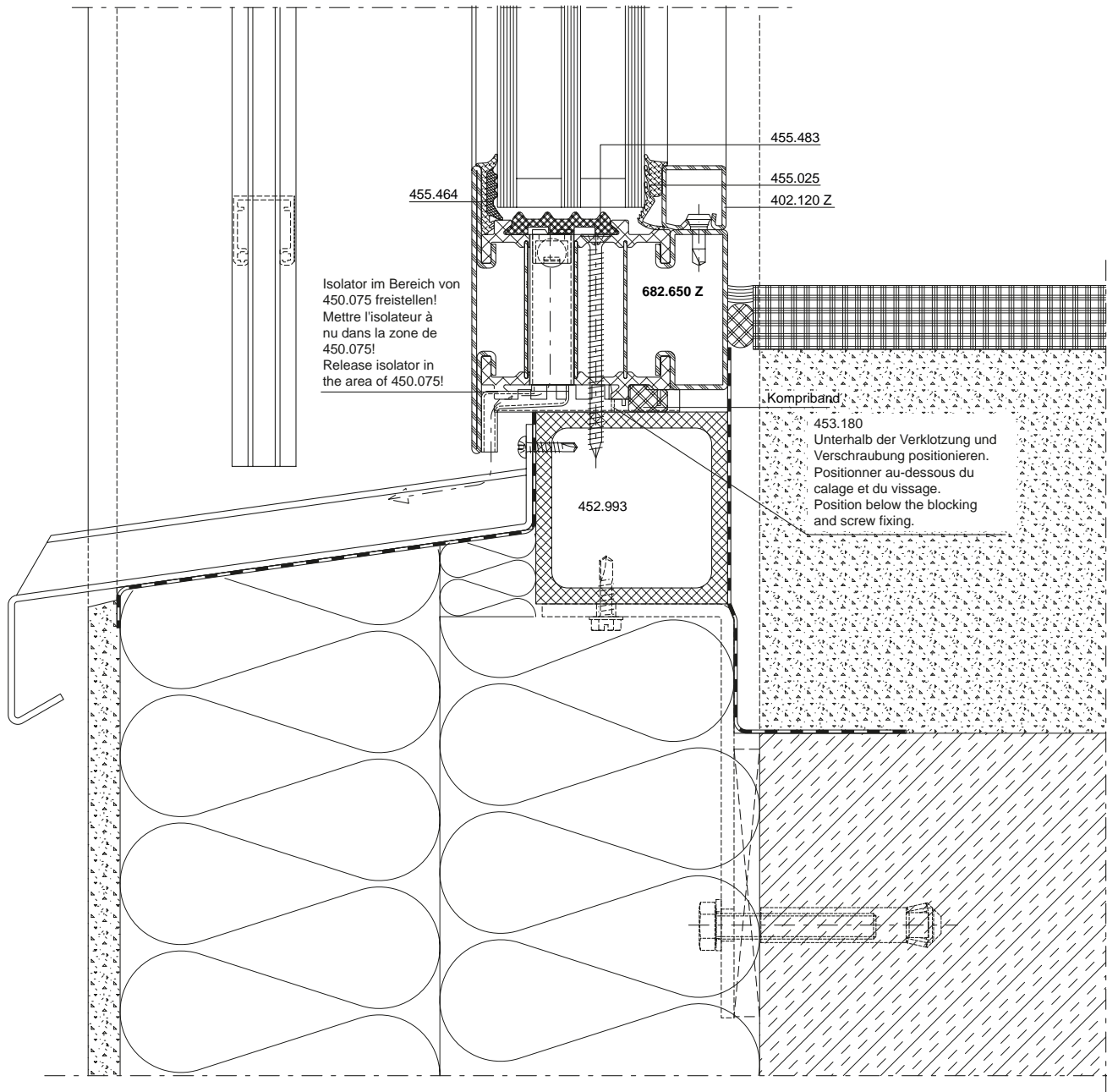

DXF

DWG

12-0201-A-006

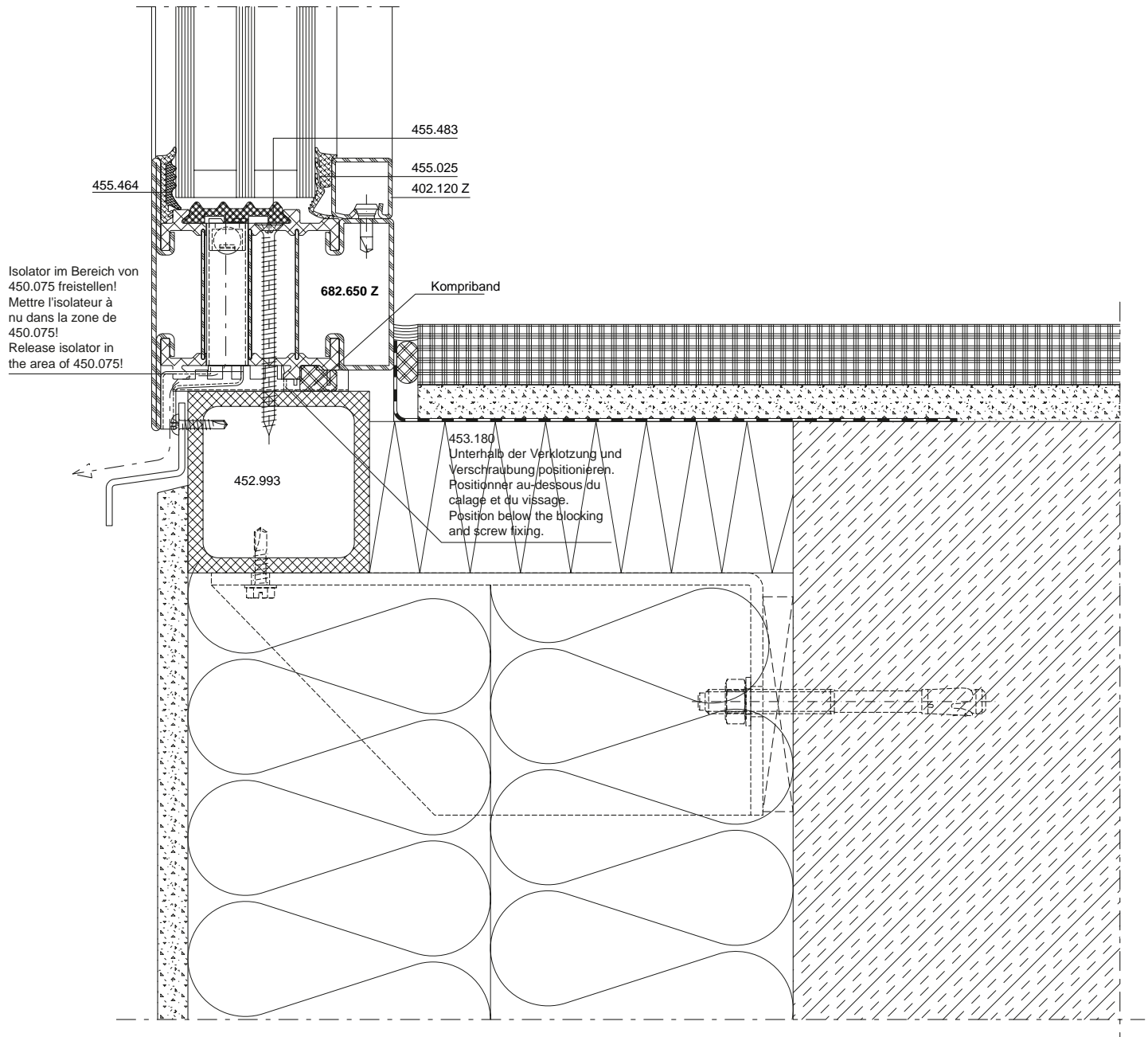

DXF

DWG

12-0201-A-008

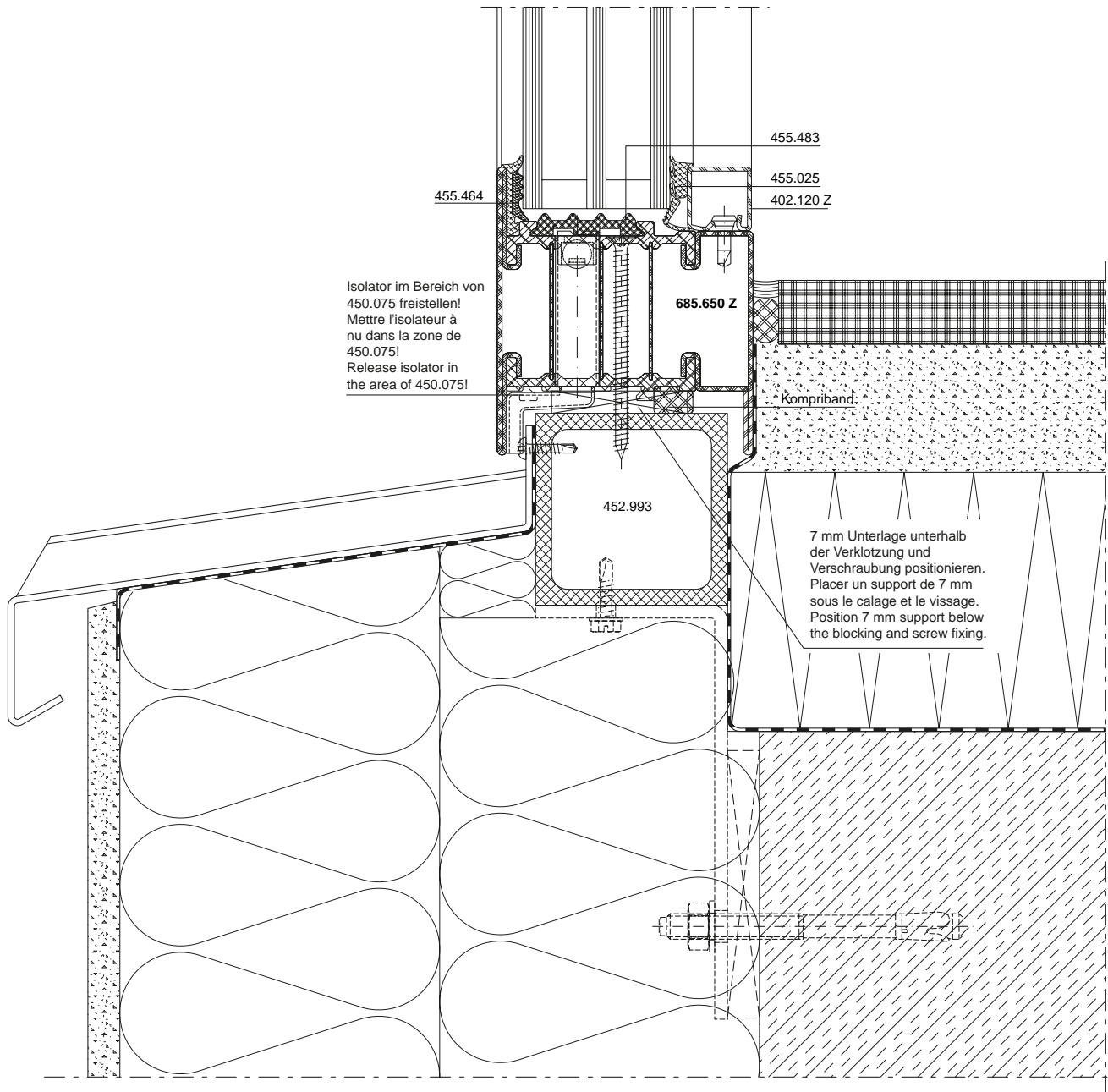

DXF

DWG

12-0201-A-009

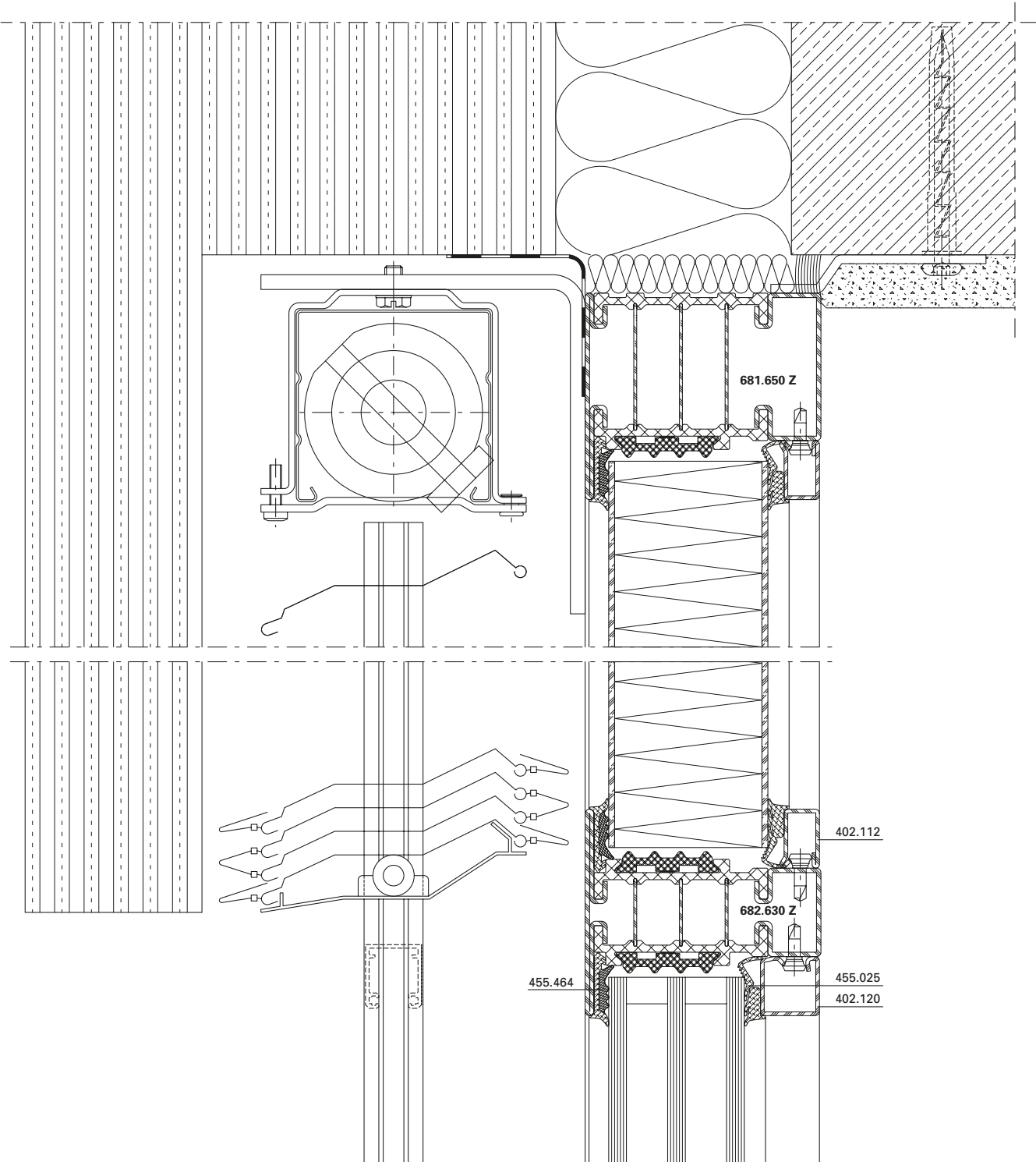

DXF

DWG

12-0201-A-010

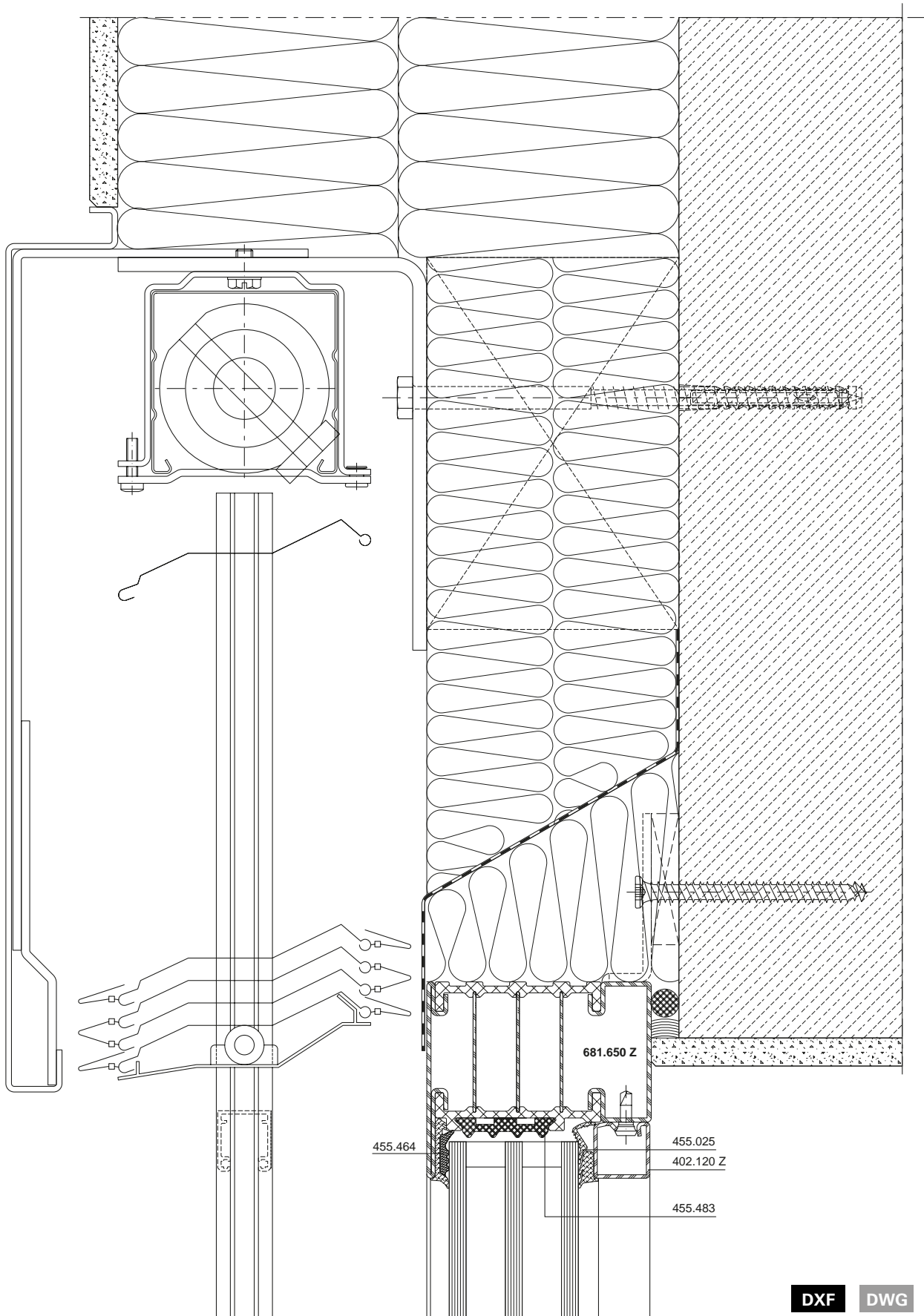

Leistungswerte
 Fenster aus Stahl

Caractéristiques de performances
 Fenêtres en acier







Performance values
 Windows made of steel

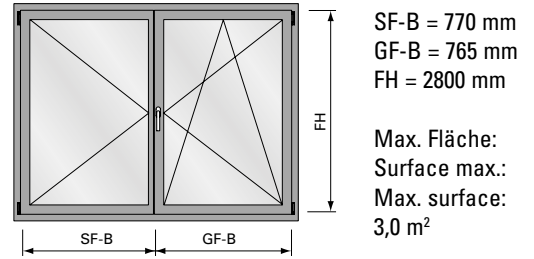
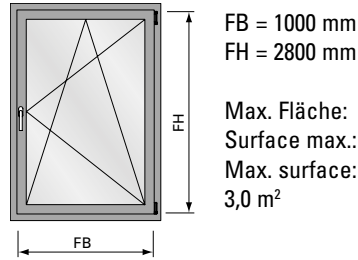

Schlagregendichtheit
 Luftdurchlässigkeit
 Widerstand bei Windlast

Étanchéité à la pluie battante
 Perméabilité à l'air
 Résistance à la pression du vent

Watertightness
 Air permeability
 Resistance to wind load

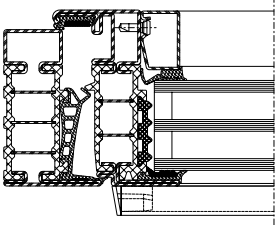

	 EN 12208	 EN 12207	 EN 12210	 EN 12208	 EN 12207	 EN 12210
	Klasse E750 Classe E750 Class E750	Klasse 4 Classe 4 Class 4	Klasse C4/B4 Classe C4/B4 Class C4/B4	Klasse 8A Classe 8A Class 8A	Klasse 4 Classe 4 Class 4	Klasse C4/B4 Classe C4/B4 Class C4/B4
Größenänderungen Variations dimensionnelles Size changes	-100%	-100%	-100%	-100%	-100%	-100%

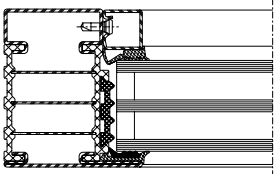
	 EN 12208	 EN 12207	 EN 12210
	Klasse E750 Classe E750 Class E750	Klasse 4 Classe 4 Class 4	Klasse C4/B4 Classe C4/B4 Class C4/B4
Grösse Festverglasung nach objektspezifischer Glasstatik Taille du vitrage fixe selon la statique du verre spécifique à l'objet Size of fixed glazing according to the glass statics of the specific project			

Leistungswerte für Sondergeometrien

Caractéristiques de performances pour géométrie spéciale

Performances values for special geometry

Schlagregendichtheit
 Luftdurchlässigkeit
 Widerstand bei Windlast

Étanchéité à la pluie battante
 Perméabilité à l'air
 Résistance à la pression du vent

Watertightness
 Air permeability
 Resistance to wind load

Atelierfenster
 Fenêtre trapézoïdale
 Studio window

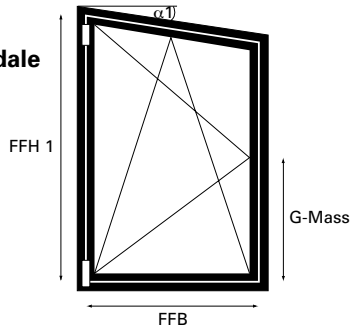

FFB = 1250 mm
 FFH 1 = 2760 mm

Max. Fläche:
 Surface max.:
 Max. surface:
 2.0 m²

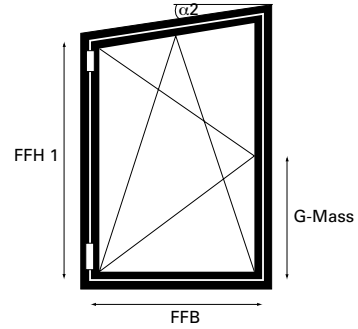

FFB = 1250 mm
 FFH 2 = 2760 mm

Max. Fläche:
 Surface max.:
 Max. surface:
 2.0 m²

	 EN 12208	 EN 12207	 EN 12210
Anschweissband (Drehfenster) Paumelle à souder (Fenêtre à la française) Weld-on hinge (Side-hung window)	Klasse 9A Classe 9A Class 9A	Klasse 4 Classe 4 Class 4	Klasse C4/B4 Classe C4/B4 Class C4/B4
Fensterbeschlag Ferrure de fenêtre Window fitting	Klasse 9A Classe 9A Class 9A	Klasse 4 Classe 4 Class 4	Klasse C4/B4 Classe C4/B4 Class C4/B4
Größenänderungen Variations dimensionnelles Size changes	-100%	-100%	-100%

Leistungswerte für Sondergeometrien

Caractéristiques de performances pour géométrie spéciale

Performances values for special geometry

Schlagregendichtheit
 Luftdurchlässigkeit
 Widerstand bei Windlast

Etanchéité à la pluie battante
 Perméabilité à l'air
 Résistance à la pression du vent

Watertightness
 Air permeability
 Resistance to wind load

Kippfenster
 Fenêtre à soufflet
 Bottom-hung window

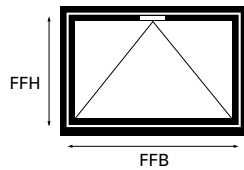

	 EN 12208	 EN 12207	 EN 12210
Anschweisband Schnäpper* Paumelle à souder Loqueteau d'imposte* Weld-on hinge Catch*	Klasse 9A Classe 9A Class 9A	Klasse 4 Classe 4 Class 4	Klasse C3/B3 Classe C3/B3 Class C3/B3
Größenänderungen Variations dimensionnelles Size changes	-100%	-100%	-100%

FFB = 2760 mm
 FFH = 960 mm

Max. Fläche:
 Surface max.:
 Max. surface:
 2.84 m²

* max. Verriegelungsabstand = 1810 mm
 * distance de verrouillage max. = 1810 mm
 * max. distance between locking points = 1810 mm

	 EN 12208	 EN 12207	 EN 12210
Anschweisband Oberlichtöffner F200* Paumelle à souder Ferrure d'imposte F200* Weld-on hinge Top light opener F200*	Klasse 9A Classe 9A Class 9A	Klasse 4 Classe 4 Class 4	Klasse C4/B4 Classe C4/B4 Class C4/B4
Größenänderungen Variations dimensionnelles Size changes	-100%	-100%	-100%

FFB = 2800 mm
 FFH = 960 mm

Max. Fläche:
 Surface max.:
 Max. surface:
 2.84 m²

* max. Verriegelungsabstand = 1440 mm
 * distance de verrouillage max. = 1440 mm
 * max. distance between locking points = 1440 mm

Leistungswerte für Sondergeometrien

Caractéristiques de performances pour géométrie spéciale

Performances values for special geometry





Schlagregendichtheit
 Luftdurchlässigkeit
 Widerstand bei Windlast

Étanchéité à la pluie battante
 Perméabilité à l'air
 Résistance à la pression du vent

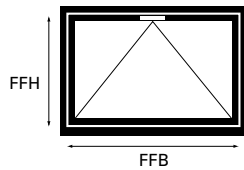
Watertightness
 Air permeability
 Resistance to wind load

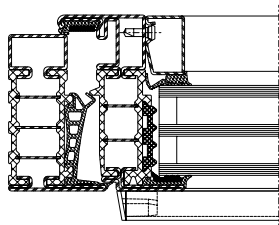
Kippfenster
 Fenêtre à soufflet
 Bottom-hung window



	 EN 12208	 EN 12207	 EN 12210	
	Anschweisband Kettenantrieb EM/2* Paumelle à souder Entraînement à chaîne EM/2* Weld-on hinge Chaîne drive EM/2*	Klasse 9A Classe 9A Class 9A	Klasse 4 Classe 4 Class 4	Klasse C4/B4 Classe C4/B4 Class C4/B4
	Größenänderungen Variations dimensionnelles Size changes	-100%	-100%	-100%

FFB = 2760 mm
 FFH = 960 mm

Max. Fläche:
 Surface max.:
 Max. surface:
 2.84 m²

- * max. Verriegelungsabstand = 1810 mm
- * distance de verrouillage max. = 1810 mm
- * max. distance between locking points = 1810 mm

Leistungswerte für Sondergeometrien

Caractéristiques de performances pour géométrie spéciale

Performances values for special geometry

Schlagregendichtheit
 Luftdurchlässigkeit
 Widerstand bei Windlast

Etanchéité à la pluie battante
 Perméabilité à l'air
 Résistance à la pression du vent

Watertightness
 Air permeability
 Resistance to wind load

Kippfenster
 Fenêtre à soufflet
 Bottom-hung window

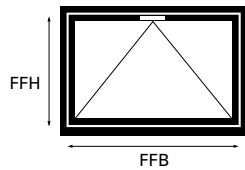

	 EN 12208	 EN 12207	 EN 12210
Kippflügelband Standard Schnäpper* Charnière d'imposte Standard Loqueteau d'imposte* Bottom-hung hinge Standard Catch*	Klasse 8A Classe 8A Class 8A	Klasse 2 Classe 2 Class 2	Klasse C3/B3 Classe C3/B3 Class C3/B3
Größenänderungen Variations dimensionnelles Size changes	-100%	-100%	-100%

FFB = 2760 mm
 FFH = 960 mm

Max. Fläche:
 Surface max.:
 Max. surface:
 2.84 m²

* max. Verriegelungsabstand = 1810 mm
 * distance de verrouillage max. = 1810 mm
 * max. distance between locking points = 1810 mm

	 EN 12208	 EN 12207	 EN 12210
Kippflügelband Standard Oberlichtöffner F200* Charnière d'imposte Standard Ferrure d'imposte F200* Bottom-hung hinge Standard Top light opener F200*	Klasse 6A Classe 6A Class 6A	Klasse 2 Classe 2 Class 2	Klasse C2/B2 Classe C2/B2 Class C2/B2
Größenänderungen Variations dimensionnelles Size changes	-100%	-100%	-100%

FFB = 2760 mm
 FFH = 960 mm

Max. Fläche:
 Surface max.:
 Max. surface:
 2.84 m²

* max. Verriegelungsabstand = 1440 mm
 * distance de verrouillage max. = 1440 mm
 * max. distance between locking points = 1440 mm

Leistungswerte für Sondergeometrien

Caractéristiques de performances pour géométrie spéciale

Performances values for special geometry





Schlagregendichtheit
 Luftdurchlässigkeit
 Widerstand bei Windlast

Étanchéité à la pluie battante
 Perméabilité à l'air
 Résistance à la pression du vent

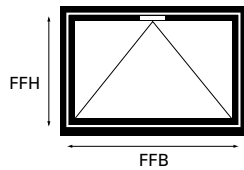
Watertightness
 Air permeability
 Resistance to wind load

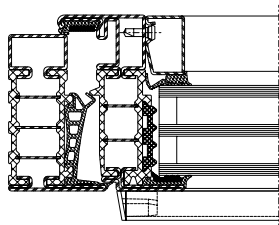
Kippfenster
 Fenêtre à soufflet
 Bottom-hung window



	 EN 12208	 EN 12207	 EN 12210	
	Kippflügelband Standard Kettenantrieb EM/2* Charnière d'imposte Standard Entraînement à chaîne EM/2* Bottom-hung hinge Standard Chaîne drive EM/2*	Klasse 7A Classe 7A Class 7A	Klasse 2 Classe 2 Class 2	Klasse C3/B3 Classe C3/B3 Class C3/B3
	Größenänderungen Variations dimensionnelles Size changes	-100%	-100%	-100%

FFB = 2760 mm
 FFH = 960 mm

Max. Fläche:
 Surface max.:
 Max. surface:
 2.84 m²

- * max. Verriegelungsabstand = 1810 mm
- * distance de verrouillage max. = 1810 mm
- * max. distance between locking points = 1810 mm

U_f-Werte
(nach EN ISO 10077-2:2018-01)

Auf den folgenden Seiten finden Sie die U_f-Werte für die verschiedenen Anwendungen von Janisol HI-Fenster.

Sie basieren auf folgenden Grundlagen:

- Stahl
- Profile bandverzinkter Stahl, unbeschichtet
 - Stahl-Glasleisten
 - Trockenverglasung

Valeurs U_f
(selon EN ISO 10077-2:2018-01)

Vous trouverez les valeurs U_f pour les différentes applications Janisol HI fenêtres dans les pages qui suivent.

Elles se basent sur les principes suivants:

- Acier
- Profilés en bande d'acier zingué, sans revêtement
 - Parcloses en acier
 - Vitrage à sec

U_f values
(according to
EN ISO 10077-2:2018-01)

On the following pages you will find the U_f values for the various applications for Janisol HI windows.

They are based on the following:

- Steel
- Strip galvanised steel profiles, uncoated
 - Steel glazing beads
 - Glazing with dry glazing

U_f-Werte
 (nach EN ISO 10077-2:2018-01)

Valeurs U_f
 (selon EN ISO 10077-2:2018-01)

U_f values
 (according to EN ISO 10077-2:2018-01)

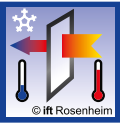
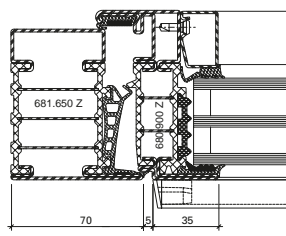
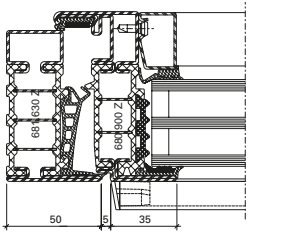
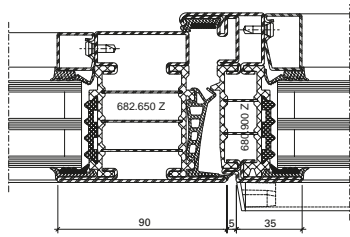
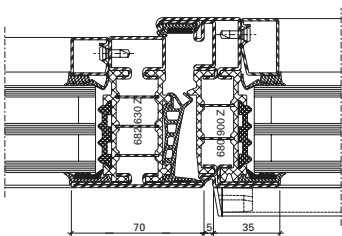
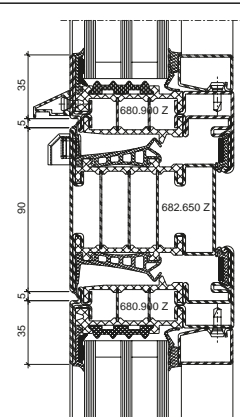
	Füllelementstärken Elements de remplissages Infill elements			
	≥ 46 mm	≥ 36 mm	≥ 36 mm*	≥ 24 mm*
	1,2 W/m²K	1,2 W/m²K	1,3 W/m²K	1,3 W/m²K
	1,3 W/m²K	1,3 W/m²K	1,4 W/m²K	1,5 W/m²K
	1,1 W/m²K	1,2 W/m²K	1,3 W/m²K	1,4 W/m²K
	1,2 W/m²K	1,3 W/m²K	1,4 W/m²K	1,5 W/m²K
	1,2 W/m²K	1,3 W/m²K	1,4 W/m²K	1,4 W/m²K

* ohne Dämmprofil
 * sans profilé isolant
 * without insulating profile

U_f-Werte
 (nach EN ISO 10077-2:2018-01)

Valeurs U_f
 (selon EN ISO 10077-2:2018-01)

U_f values
 (according to EN ISO 10077-2:2018-01)

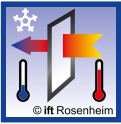
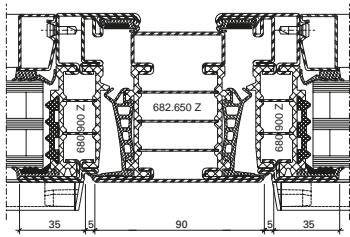
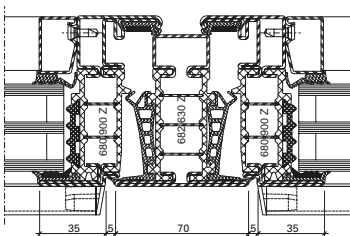
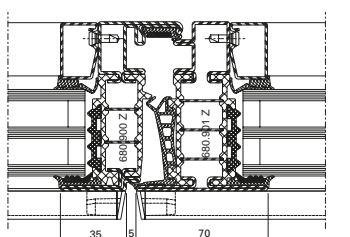
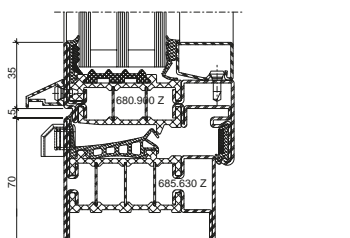
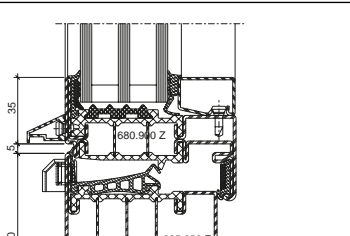
	Füllelementstärken Elements de remplissages Infill elements			
	≥ 46 mm	≥ 36 mm	≥ 36 mm*	≥ 24 mm*
	1,2 W/m ² K	1,3 W/m ² K	1,4 W/m ² K	1,4 W/m ² K
	1,3 W/m ² K	1,4 W/m ² K	1,5 W/m ² K	1,5 W/m ² K
	1,2 W/m ² K	1,3 W/m ² K	1,5 W/m ² K	1,6 W/m ² K
	1,2 W/m ² K	1,2 W/m ² K	1,3 W/m ² K	1,4 W/m ² K
	1,1 W/m ² K	1,1 W/m ² K	1,2 W/m ² K	1,2 W/m ² K

* ohne Dämmprofil
 * sans profilé isolant
 * without insulating profile

U_f-Werte
 (nach EN ISO 10077-2:2018-01)

Valeurs U_f
 (selon EN ISO 10077-2:2018-01)

U_f values
 (according to EN ISO 10077-2:2018-01)

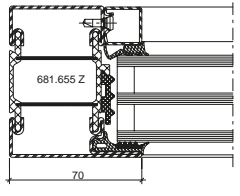
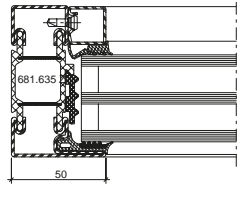
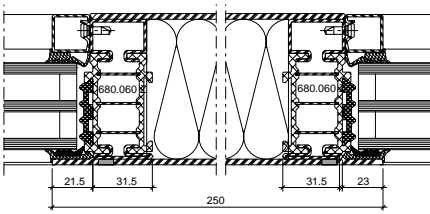
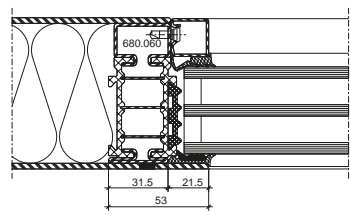
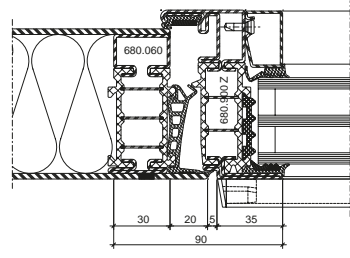
	Füllelementstärken Elements de remplissages Infill elements			
	≥ 46 mm	≥ 36 mm	≥ 36 mm*	≥ 24 mm*
	1,2 W/m²K	1,3 W/m²K	1,4 W/m²K	1,6 W/m²K
	1,4 W/m²K	1,5 W/m²K	1,7 W/m²K	1,9 W/m²K
	0,74 W/m²K	0,77 W/m²K	0,85 W/m²K	0,91 W/m²K
	1,2 W/m²K	1,3 W/m²K	1,4 W/m²K	1,5 W/m²K
	1,3 W/m²K	1,4 W/m²K	1,5 W/m²K	1,6 W/m²K

* ohne Dämmprofil
 * sans profilé isolant
 * without insulating profile

U_f-Werte
 (nach EN ISO 10077-2:2018-01)

Valeurs U_f
 (selon EN ISO 10077-2:2018-01)

U_f values
 (according to EN ISO 10077-2:2018-01)

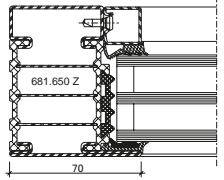
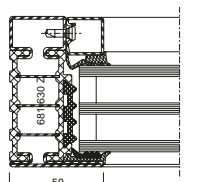
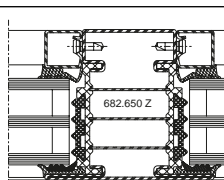
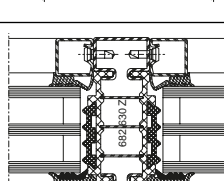
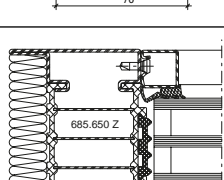
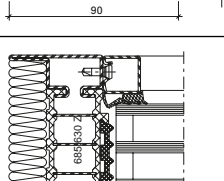
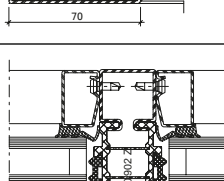
	Füllelementstärken Elements de remplissages Infill elements			
	≥ 46 mm	≥ 36 mm	≥ 36 mm*	≥ 24 mm*
	0,89 W/m²K	0,95 W/m²K	1,1 W/m²K	1,2 W/m²K
	1,0 W/m²K	1,1 W/m²K	1,3 W/m²K	1,4 W/m²K
	0,84 W/m²K	0,93 W/m²K	1,1 W/m²K	1,3 W/m²K
	0,93 W/m²K	1,0 W/m²K	1,3 W/m²K	1,5 W/m²K
	0,80 W/m²K	0,85 W/m²K	0,95 W/m²K	1,0 W/m²K
	0,88 W/m²K	0,95 W/m²K	1,1 W/m²K	1,2 W/m²K
	0,93 W/m²K	1,1 W/m²K	1,3 W/m²K	1,4 W/m²K

* ohne Dämmprofil
 * sans profilé isolant
 * without insulating profile



Schalldämmung

Ausführungsvarianten

Die nachfolgende Typenübersicht ergibt einen Überblick über die beurteilten Varianten.

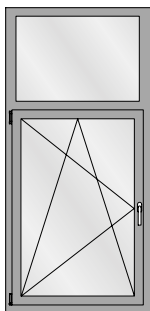
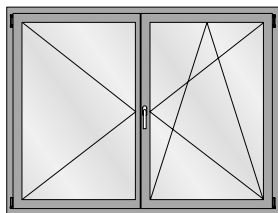
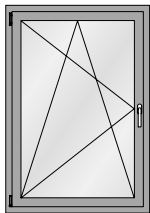

Isolation phonique

Modèles

L'aperçu des types suivant fournit une vue d'ensemble des variantes examinées.

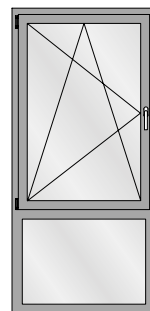
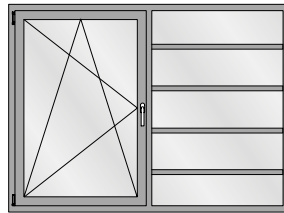
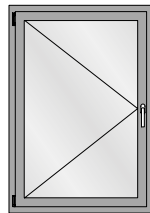

Sound insulation

Design range

The following overview of types provides an overview of the evaluated designs.



Tabelle A1
 Korrekturtabelle für Janisol HI-Fenster
 mit Mehrscheiben-Isolierglas

Tableau A1
 Tableau de correction pour les
 fenêtres Janisol HI avec vitrage isolant
 multi-vitres

Table A1
 Correction table for Janisol HI
 windows with multi-pane insulating
 glass

	1	2	7	8	9	10	11	12	13	14	15
	$R_{W(C, Ctr)}$ dB	Isolierglaseinheit Unité d'isolation Insulating glass unit $R_{W, P, Glas}$ dB	Korrekturen Corrections Corrections								
			K_{RA} dB	K_S dB	K_{FV} dB	K_{Nass} dB	$K_{G 0,4}$ dB	$K_{G 1,0}$ dB	$K_{G 1,8}$ dB	$K_{G 2,6}$ dB	$K_{G 3,2}$ dB
1	33 (-2; -6)	31	-2	0	-1	0	0	0	-1	-2	-3
2	34 (-2; -6)	32	-2	0	-1	0	0	0	-1	-2	-3
3	35 (-2; -6)	34	-2	0	-1	0	0	0	-1	-2	-3
4	36 (-2; -6)	35	-2	0	-1	-1	0	0	-1	-2	-3
5	37 (-2; -6)	37	-2	0	0	-1	0	0	-1	-2	-3
6	38 (-2; -6)	39	-2	0	0	-1	0	0	-1	-2	-3
7	39 (-2; -6)	40	-2	0	0	-1	0	0	-1	-2	-3
8	40 (-2; -4)	41	-2	0	0	-1	-1	0	-1	-2	-3
9	41 (-2; -4)	42	0	0	0	-1	-2	0	-1	-2	-3
10	42 (-2; -4)	43	0	-1	0	-1	-2	0	-1	-2	-3
11	43 (-2; -4)	44	0	-2	0	-1	-2	0	-1	-2	-3
12	44 (-2; -5)	45	0	-2	0	-1	-3	0	-1	-2	-3
13	45 (-2; -5)	49	0	-2	+1	-1	-3	0	-1	-2	-3
14	46 (-2; -6)	50	-1	-3	0	-1	-4	-1	-1	-2	-3

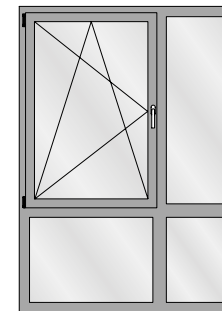
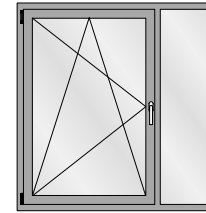
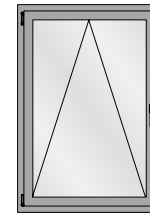
Der aus der Tabelle A1 abzulesende Wert für die Schalldämmung $R_{W, Fenster}$ beträgt:

La valeur à relever sur le tableau A1 concernant l'isolement contre les sons aériens $R_{W, Fenêtre}$ est la suivante:

The value taken from table A1 for the sound insulation $R_{W, Window}$ is:

$$R_{W, Fenster} = R_W + K_{RA} + K_S + K_{FV} + K_{Nass} + K_{G 0,4} + K_{G 1,8} + K_{G 2,6} + K_{G 3,2} \text{ dB}$$

K_{RA} Korrekturwert für einen Rahmenanteil < 30%. Der Rahmenanteil ist die Gesamtfläche des Fensters abzüglich der sichtbaren Scheibengröße. K_{RA} darf bei Festverglasungen nicht berücksichtigt werden.

K_S Korrekturwert für Stulpfenster

K_{FV} Korrekturwert für Festverglasungen mit erhöhtem Scheibenanteil

K_{Nass} Korrekturwert für Nassverglasung

$K_{G 0,4}$ Korrekturwert für Einzelscheiben mit einer Glasfläche $\leq 0,4 \text{ m}^2$. Die Korrektur gilt auch für Konstruktionen mit glasteilenden Sprossen.

$K_{G 1,0}$ Korrekturwert für Einzelscheiben mit einer Glasfläche $\geq 1,0 \text{ m}^2$

$K_{G 1,8}$ Korrekturwert für Einzelscheiben mit einer Glasfläche $\geq 1,8 \text{ m}^2$

$K_{G 2,6}$ Korrekturwert für Einzelscheiben mit einer Glasfläche $\geq 2,6 \text{ m}^2$

$K_{G 3,2}$ Korrekturwert für Einzelscheiben mit einer Glasfläche $\geq 3,2 \text{ m}^2$

R_W bewertetes Schalldämm-Mass des Fensters in Abhängigkeit von der Schalldämmung $R_{W,P, Glas}$

$R_{W,P, Glas}$ bewertetes Schalldämm-Mass (Prüfwert) der Isolierverglasung. Die Werte müssen über eine Prüfung nach ISO 140-3 an einem Prüfmuster im Format 1230 x 1480 mm ermittelt und durch einen Prüfbericht einer anerkannten Prüfstelle nachgewiesen werden. Alternativ können generische Daten nach DIN EN 12758 verwendet werden.

K_{RA} Valeur de correction pour un pourcentage de cadre < 30%. Le pourcentage du cadre est la surface totale de la fenêtre déduite de la dimension de vitre visible. K_{RA} ne doit pas être pris en compte sur les vitrages fixes.

K_S Valeur de correction pour fenêtres à deux vantaux

K_{FV} Valeur de correction pour vitrages fixes à fort pourcentage de vitre

K_{Nass} Valeur de correction pour vitrage avec mastic

$K_{G 0,4}$ Valeur de correction pour vitres individuelles avec une surface vitrée $\leq 0,4 \text{ m}^2$. La correction s'applique aussi aux constructions à meneaux séparant les vitres.

$K_{G 1,0}$ Valeur de correction pour vitres individuelles avec surface vitrée $\geq 1,0 \text{ m}^2$

$K_{G 1,8}$ Valeur de correction pour vitres individuelles avec surface vitrée $\geq 1,8 \text{ m}^2$

$K_{G 2,6}$ Valeur de correction pour vitres individuelles avec surface vitrée $\geq 2,6 \text{ m}^2$

$K_{G 3,2}$ Valeur de correction pour vitres individuelles avec surface vitrée $\geq 3,2 \text{ m}^2$

R_W Mesure d'isolement contre les sons aériens des fenêtres évaluée suivant l'isolement phonique $R_{W,P, vitrage}$

$R_{W,P, vitrage}$ Mesure d'isolement contre les sons aériens (valeur d'essai) du vitrage isolant évaluée. Les valeurs doivent être déterminées par un essai suivant ISO 140-3 sur un spécimen de format 1230x1480 mm et attestées par le procès-verbal d'un bureau de vérification homologué. Alternativement, il est possible d'utiliser des données génériques suivant DIN EN 12758.

K_{RA} Correction value for a frame proportion < 30%. The frame proportion is the total surface area of the window less the visible pane area. K_{RA} must not be taken into account for fixed glazing.

K_S Correction value for double-vent windows

K_{FV} Correction value for fixed glazing with increased proportion of pane

K_{Nass} Correction value for glazing with sealing

$K_{G 0,4}$ Correction value for single panes with a glass area $\leq 0,4 \text{ m}^2$. The correction also applies to buildings with glazing bars

$K_{G 1,0}$ Correction value for single panes with a glass area $\geq 1,0 \text{ m}^2$

$K_{G 1,8}$ Correction value for single panes with a glass area $\geq 1,8 \text{ m}^2$

$K_{G 2,6}$ Correction value for single panes with a glass area $\geq 2,6 \text{ m}^2$

$K_{G 3,2}$ Correction value for single panes with a glass area $\geq 3,2 \text{ m}^2$

R_W Airborne sound reduction index of windows depending on the sound insulation $R_{W,P, glazing}$

$R_{W,P, glazing}$ Airborne sound reduction index (test value) of insulating glazing. The values must be calculated using a test conducted in accordance with ISO 140-3 for a specimen with the dimensions 1230 x 1480 mm and confirmed by a test report of a recognised test centre. Alternatively, generic data can be used in accordance with DIN EN 12758.

Grafische Planungsdaten wie z.B. Anwendungsbeispiele, Konstruktionsdetails, Anschlüsse am Bau, die in unseren physischen oder elektronischen Dokumentationsunterlagen enthalten sind, sind schematische Darstellungen. Gleiches gilt für digitale Medien wie CAD Dateien oder BIM Modelle.

Sie sollen den ausführenden Metallbauer und/oder Fachplaner bei der Planung und Ausführung eines Projektes unterstützen. Sie sind im konkreten Anwendungsfall durch den ausführenden Metallbauer und/oder Fachplaner auf die Verwendbarkeit im konkreten betroffenen Projekt hinsichtlich rechtlichen/regulatorischen aber auch technischen objektspezifischen Anforderungen zu überprüfen und ggfs. eigenverantwortlich anzupassen.

Bei der Überprüfung, der spezifischen Planung und der Umsetzung sind die objektspezifischen Rahmenbedingungen (Material der Bausubstanz, Dimension des Einbauelements, Farbe, Exposition, Lasteinwirkung, etc.) sowie der geltende Stand der Technik einschliesslich aller anwendbaren Normen und technischen Richtlinien eigenverantwortlich zu beachten.

Falls das vorliegende Dokument Differenzen zur aktuellen deutschen Version (Artikel Nr. K1214220) aufweist, gilt in jedem Fall der deutsche Originaltext in der jeweils geltenden Fassung im Jansen Docu Center.

Alle Ausführungen dieser Dokumentation haben wir sorgfältig und nach bestem Wissen zusammengestellt. Wir können aber keine Verantwortung für die Benutzung der vermittelten Vorschläge und Daten übernehmen. Wir behalten uns technische Änderungen ohne Vorankündigung vor.

Les données de planification graphiques, comme les exemples d'application, détails de construction et raccordements au bâtiment, fournies dans notre documentation physique et numérique sont des représentations schématiques. Il en va de même pour les médias numériques comme les fichiers CAD ou modèles BIM.

Leur but est de faciliter la planification et réalisation d'un projet par les constructeurs métalliques et/ou concepteurs. Concrètement, elles doivent être vérifiées par le constructeur métallique et/ou le concepteur et, le cas échéant, modifiées de son propre chef pour s'assurer qu'elles concordent avec le projet concerné et qu'elles répondent aux exigences techniques spécifiques ainsi qu'aux dispositions légales et réglementaires.

Lors de la vérification, de la planification spécifique et de la mise en œuvre, il y a lieu de tenir compte des conditions spécifiques à l'objet (matériaux du bâtiment, dimension de l'élément d'insert, couleur, exposition, effet de charge, etc.) ainsi que de l'état actuel de la technique, y compris toutes les normes et directives techniques applicables.

En cas de divergence entre le présent document et la version allemande (no d'article K1214220), c'est dans tous les cas le texte original allemand qui prévaut dans sa version actuelle disponible dans le Jansen Docu Center.

Nous avons apporté le plus grand soin à l'élaboration de cette documentation. Cependant, nous déclinons toute responsabilité pour l'utilisation faite de nos propositions et de nos données.

Nous nous réservons le droit de procéder à des modifications techniques sans préavis.

Graphical planning data such as application examples, construction details, connections on site that are contained in our physical or electronic documentation components are schematic representations. The same applies to digital media such as CAD files or BIM models.

They are intended to support the metal worker and/or design engineer in planning and executing projects. In the specific case of application they are to be checked by the metal worker and/or design engineer in terms of their usability in the specific project concerned with regard to legal/regulatory and technical property-specific requirements and adjusted if necessary at the latter's own responsibility.

The property-specific underlying conditions (construction material, dimensions of installation element, colour, exposure, load effect etc.) and current state of the art including all applicable norms and technical guidelines are to be taken into consideration at the metal worker and/or design engineer's own responsibility during the review, specific planning and implementation.

If there are any differences between this document and the current German version (item number K1214220), the latest version of the original German text in the Jansen Docu Center shall prevail.

All the information contained in this documentation is given to the best of our knowledge and ability. However, we decline all responsibility for the use made of these suggestions and data.

We reserve the right to effect technical modifications without prior warning.

Inhaltsverzeichnis
Sommaire
Content

Janisol HI Fenster
Janisol HI fenêtres
Janisol HI windows

Systemübersicht

Merkmale
Leistungseigenschaften
Systemausführungen
Typenübersicht

Sommaire du système

Caractéristiques
Caractéristiques de performance
Exécutions de système
Sommaire des types

Summary of system

Characteristics
Performance characteristics
System versions
Summary of types

2

Profilsortiment

Assortiment de profilé

Range of profiles

9

Beispiele

Schnittpunkte
Konstruktionsdetails
Anschlüsse am Bau

Exemples

Coupes de détails
Détails de construction
Raccords au mur

Examples

Section details
Construction details
Attachment to structure

12

Leistungseigenschaften

Caractéristiques de performance

Performance characteristics

38







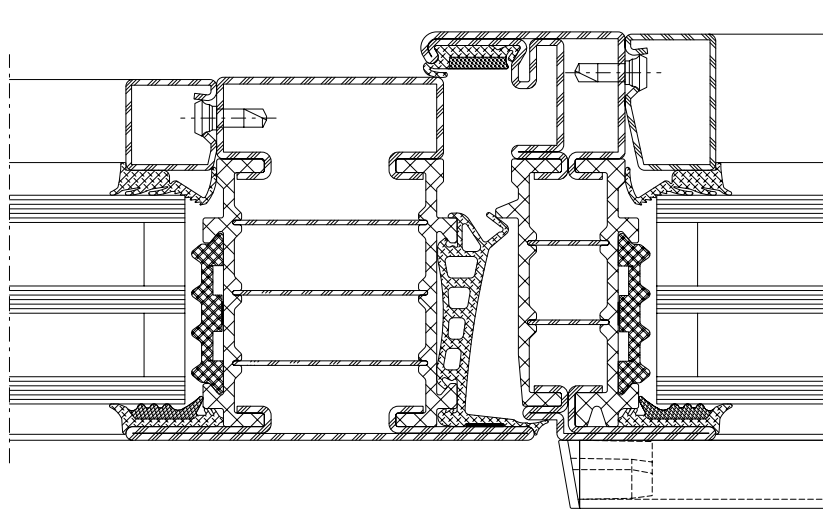

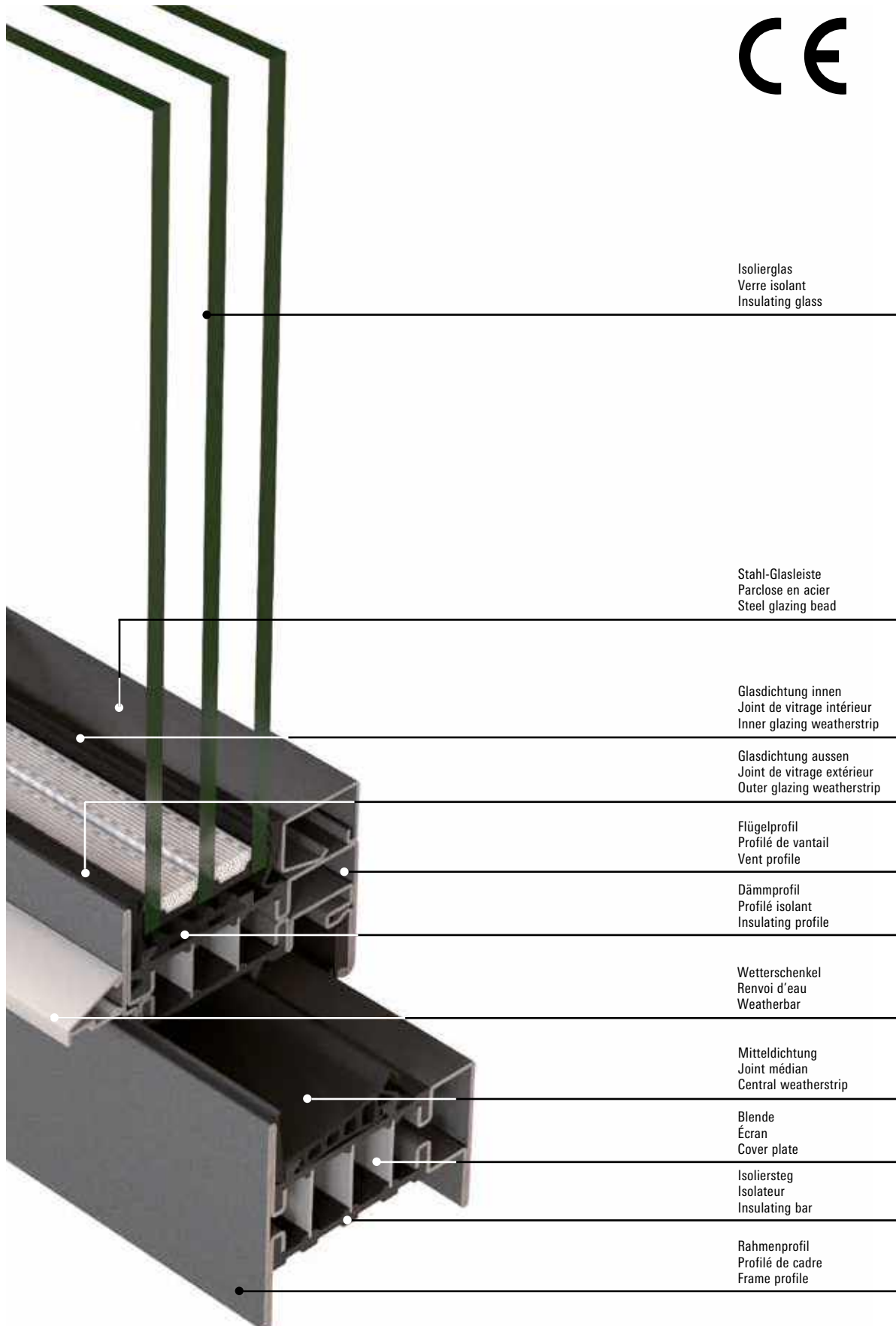



Merkmale
Caractéristiques
Characteristics

Janisol HI Fenster
Janisol HI fenêtres
Janisol HI windows

- Hervorragende wärmetechnische Eigenschaften für maximale Anforderungen
- Bautiefe Flügel 90 mm, Festverglasung 80 mm
- Schmale Profilansichten: Rahmen 50 resp. 70 mm, Pfosten/Riegel 70 resp. 90 mm, Flügel 35 mm, Stulpflügelpartie 110 mm
- Isolierstege mit besten bauphysikalischen Eigenschaften aus glasfaserverstärktem Kunststoff
- Mit Euro-Beschlagsnute für Dreh-, Drehkipp-, Stulp- und Kippflügel-Fenster
- Fensterflügel Größen bis max. 2800 mm Höhe
- Fensterflügel-Gewichte: verdeckt liegend bis 180 kg, aufgesetzt bis 150 kg
- Glasdicke für Fensterflügel 24-67 mm, für Festverglasung 24-57 mm
- Systemprüfung nach Produktnorm EN 14351-1 für alle Fenster-Öffnungsarten
- Sehr gute statische Werte, hohe mechanische Festigkeiten
- Dauerfunktionsprüfung nach EN 12400 Drehfenster Klasse 4 Drehkippfenster Klasse 3
- Für Nasslack- oder Pulverbeschichtung geeignet
- Excellentes propriétés thermiques répondant à des exigences maximum
- Profondeur de montage vantail 90 mm, vitrage fixe 80 mm
- Profilés très fins: Cadre 50 et 70 mm, montant/traverse 70 ou 90 mm, vantail 35 mm, partie à deux vantaux à la française 110 mm
- Traverses isolantes aux excellentes propriétés physiques en matière plastique renforcé par fibres de verre
- Avec rainure de ferrure Euro pour fenêtres à la française, oscillo-battantes, à deux vantaux et à soufflet
- Tailles d'ouvrant de fenêtre jusqu'à max. 2800 mm de hauteur
- Poids des ouvrants de fenêtre: non apparents jusqu'à 180 kg, plaqués jusqu'à 150 kg
- Épaisseur de vitrage pour ouvrants de fenêtre 24-67 mm, pour vitrage fixe 24-57 mm
- Contrôle du système selon la norme produit EN 14351-1 pour tous les types d'ouverture de fenêtre
- Très bonnes valeurs statiques, résistances mécaniques élevées
- Durabilité mécanique selon EN 12400 Fenêtres à la française classe 4 Fenêtres oscillo-battantes classe 3
- Convient au revêtement à la peinture liquide ou poudre
- Outstanding thermal properties for the most exacting requirements
- Basic depth of vent 90 mm, fixed glazing 80 mm
- Narrow profile face widths: frame 50 or 70 mm, mullion/transom 70 or 90 mm, vent 35 mm, double-vent meeting stile assembly 110 mm
- Insulating bars with optimum structural properties made from glass fibre-reinforced plastic
- With Euro fittings groove for side-hung, turn/tilt, double-vent and bottom-hung windows
- Window vent dimensions up to max. 2800 mm in height
- Window vent weights: concealed up to 180 kg, surface-mounted up to 150 kg
- Glass thickness for window vent 24-67 mm, for fixed glazing 24-57 mm
- System testing in accordance with product standard EN 14351-1 for all window opening types
- Excellent structural values, high levels of mechanical strength
- Mechanical durability in accordance with EN 12400 Side-hung windows class 4 Turn/tilt windows class 3
- Suitable for wet paint or powder coating





Norm	Eigenschaft Caractéristique Characteristic	Klassifizierung/Wert Classification / Valeur Classification / Value														
		npd	C1 (400)	C2 (800)	C3 (1200)	C4 (1600)	C5 (2000)	1A (0)	2A (50)	3A (100)	4A (150)	5A (200)	6A (250)	7A (300)	8A (450)	9A (600)
 EN 12210	Widerstandsfähigkeit bei Windlast Résistance à la pression du vent Resistance to wind load	npd	C1 (400)	C2 (800)	C3 (1200)	C4 (1600)	C5 (2000)									
 EN 12208	Schlagregendichtheit Etanchéité à la pluie battante Watertightness	npd	1A (0)	2A (50)	3A (100)	4A (150)	5A (200)	6A (250)	7A (300)	8A (450)	9A (600)	Exxx (>750)				
 EN ISO 10140	Schalldämmung R_w (C, C_{tr}) (dB) Isolation phonique R_w (C, C_{tr}) (dB) Sound insulation R_w (C, C_{tr}) (dB)	npd	bis R_w 46 dB (-2; -6) jusqu'à R_w 46 dB (-2; -6) up to R_w 46 dB (-2; -6)													
 EN ISO 10077-2	Wärmedurchgangskoeffizient U_f (W/(m²·K)) Transmission thermique U_f (W/(m²·K)) Thermal production U_f (W/(m²·K))	npd	ab 0,74 W/m ² ·K à partir de 0,74 W/m ² ·K from 0,74 W/m ² ·K													
 EN 12207	Luftdurchlässigkeit Perméabilité à l'air Air permeability	npd	1 (150)	2 (300)	3 (600)	4 (600)										
 EN 14024	Tragfähigkeit von Sicherheitsvorrichtungen Capacité portante des dispositifs de sécurité Load-bearing capacity of safety devices		Anforderung erfüllt Exigence remplie Requirement satisfied													
 EN 14024	Metallprofile mit thermischer Trennung Profilés en métal. avec rupture de pont thermique Metal profiles with thermal barrier		CW / TC2													
 EN 12400	Dauerfunktionsprüfung Durabilité mécanique Mechanical durability	D	1 5'000	2 10'000	3 20'000	4 50'000	5 100'000	6 200'000	7 500'000	8 1'000'000						
 EN 13115	Bedienkräfte Forces de manœuvre Operating forces	npd	0	1	2											
 EN 1627	Einbruchhemmung Anti-effraction Burglar resistance	npd	1	2	3	4	5	6								
 ISO 16000	Gefährliche Substanzen Substances dangereuses Dangerous substances	npd	Anforderung erfüllt Exigence remplie Requirement satisfied													
 DIN 18008-4	Vorgefertigte absturzsichernde Verglasung Vitrage anti-chutes préfabriqué Prefabricated glazing suitable for safety barrier loading		Anhang D.1.2 erfüllt Annexe D.1.2 remplie Appendix D.1.2 satisfied													

npd = keine Leistung festgestellt
(no performance determined)

npd = Aucune performance déterminée
(no performance determined)

npd = no performance determined



Einbruchhemmende Janisol HI Fenster

- Flügelgrößen bis 1475 x 2800 mm
- Dreh-, Drehkipp-, Stulpfenster und Festverglasungen
- Beschlag als Komplettseinheit geliefert
- Prüfungen nach EN 1627 bis 1630 bis RC3

Fenêtres anti-effraction Janisol HI

- Dimensions de vantail jusqu'à 1475 x 2800 mm
- Fenêtres ouvrant à la française, oscillo-battantes, à deux vantaux et vitrages fixes
- Ferrures livrées comme unité complète
- Contrôlé selon les normes EN 1627 à 1630 jusqu'à RC3

Burglar-resistant Janisol HI windows

- Vent sizes up to 1475 x 2800 mm
- Side-hung, turn/tilt and double-vent windows and fixed glazing
- Fitting supplied as complete unit
- Tests in accordance with EN 1627 to 1630 up to RC3

Jansen Docu Center

Die Plattform zum effizienten Arbeiten mit Jansen Dokumentationen. Im Jansen Docu Center stehen alle Produktinformationen jederzeit digital in der aktuellsten Version zur Verfügung: von Architekten-Informationen über Bestell- und Fertigungskatalogen bis hin zu Anleitungen und Prospekten sowie Videos.

Die Inhalte können einfach und schnell aufgerufen werden. Ein für den Anwender komfortables papierloses Arbeiten, das zahlreiche Vorteile bietet.

Download CAD Daten

DXF

DWG

Sie können die Zeichnungen in den Formaten DXF und/oder DWG herunterladen. Klicken Sie auf das entsprechende Icon und der Download erfolgt.

Die Hinweise «Artikelbibliothek/Türbeschläge/Fensterbeschläge» bedeuten, dass Sie mit einem Klick die gesamte Artikelbibliothek des entsprechenden Systems herunterladen (Profile, Beschläge, Glasleisten, Zubehör etc.).

Info und Beratung

Gerne beraten wir Sie persönlich und stehen Ihnen bei Fragen zur Verfügung. Bitte schreiben Sie uns Ihre Anliegen an: info@jansen.com

Jansen Docu Center

La plate-forme pour travailler efficacement avec les documentations Jansen. Le Jansen Docu Center met à votre disposition les informations sur les produits, en format numérique et dans une version actualisée: des catalogues de commande et de fabrication aux instructions et prospectus, en passant par les informations destinées aux architectes et vidéos.

Les contenus sont facilement et rapidement accessibles. Une manière de travailler confortable et offrant de nombreux avantages.

Télécharger fichiers DAO

DXF

DWG

Vous pouvez télécharger les dessins aux formats DXF et/ou DWG. Cliquez sur l'icône correspondante et le téléchargement s'effectuera.

Les indications «Bibliothèque des articles/Ferures de porte/Ferrures de fenêtres» signifie que vous téléchargez la totalité de la bibliothèque des articles du système donné (profilés, ferrures, parcloles, accessoires etc.).

Info et conseils

Nous vous conseillons volontiers individuellement et sommes à votre disposition si vous avez des questions à poser. Veuillez nous envoyer votre requête à: info@jansen.com

Jansen Docu Center

The platform for working efficiently with Jansen documentation. The latest version of all the product information is available digitally at any time in the Jansen Docu Center – from order and fabrication manuals to architect information, instructions and brochures and videos.

The content can be retrieved quickly and easily. The user can work conveniently without paper, which has numerous benefits.

Download CAD files

DXF

DWG

You can download the drawings in DXF and/or DWG format. Click on the relevant icon to begin the download.

The items «Article library/Door fittings/Window fittings» means that you download the entire article library for the corresponding system with one click (profiles, fittings, glazing beads, accessories etc.).

Information and advice

We would be delighted to provide you with advice in person and are available to answer any questions you may have. Please write to us with your queries at: info@jansen.com

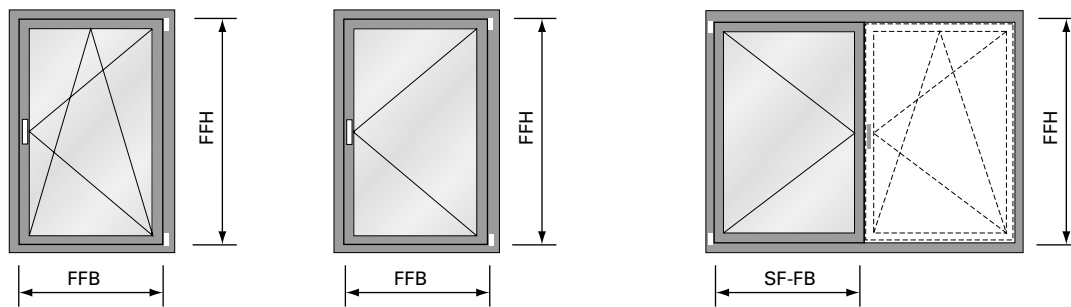

*Flügelgrößen Drehkipp-,
 Drehfenster und Stulpfenster:*

Max.	FFH = 2760 mm
	FFB = 1435 mm
	SF-FB = 1435 mm
Min.	FFH = 600 mm
	FFB = 600 mm
	SF-FB = 370 mm*
	SF-FB = 480 mm**
Max. Fläche:	3.0 m ²
Max. Gewicht:	180 kg
FFB/FFH:	≤ 2

*Grandeurs du vantail fenêtre
 oscillo-battante, à la française et
 fenêtre à deux vantaux:*

Max.	FFH = 2760 mm
	FFB = 1435 mm
	SF-FB = 1435 mm
Min.	FFH = 600 mm
	FFB = 600 mm
	SF-FB = 370 mm*
	SF-FB = 480 mm**
Surface max.:	3.0 m ²
Poids max.:	180 kg
FFB/FFH:	≤ 2

*Size of sash turn/tilt, side-hung and
 double-sash windows:*

Max.	FFH = 2760 mm
	FFB = 1435 mm
	SF-FB = 1435 mm
Min.	FFH = 600 mm
	FFB = 600 mm
	SF-FB = 370 mm*
	SF-FB = 480 mm**
Max. surface:	3.0 m ²
Max. weight:	180 kg
FFB/FFH:	≤ 2

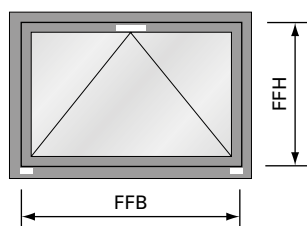

Flügelgröße Kipp-Fenster:

Max.	FFH = 2760 mm
	FFB = 2760 mm
Min.	FFH = 600 mm
	FFB = 600 mm
Max. Fläche:	3.0 m ²
Max. Gewicht:	80 kg
	(2 Bänder)
	120 kg
	(3 Bänder)
FFB/FFH:	≤ 2

*Grandeur du vantail fenêtre à
 soufflet:*

Max.	FFH = 2760 mm
	FFB = 2760 mm
Min.	FFH = 600 mm
	FFB = 600 mm
Surface max.:	3.0 m ²
Poids max.:	80 kg
	(2 paumelles)
	120 kg
	(3 paumelles)
FFB/FFH:	≤ 2

Size of sash bottom-hung window:

Max.	FFH = 2760 mm
	FFB = 2760 mm
Min.	FFH = 600 mm
	FFB = 600 mm
Max. surface:	3.0 m ²
Max. weight:	80 kg
	(2 hinges)
	120 kg
	(3 hinges)
FFB/FFH:	≤ 2

* Standard-Fensterbeschlag
 ** Verdeckt liegender Fensterbeschlag

* Ferrure de fenêtre Standard
 ** Ferrure de fenêtre non apparente

* Standard window fitting
 ** Concealed window fitting

Empfehlung Jansen:
 Flügelhöhe und Flügelbreite 1 mm ins
 Minus schneiden betreffend Sollmass.

Recommandation Jansen:
 Couper la hauteur et la largeur de
 vantail à 1 mm de moins que la cote
 de consigne.

Jansen recommendation:
 Cut sash height and sash width 1 mm
 into the minus relative to the target
 dimension.

Typenübersicht
Sommaire des types
Summary of types

Janisol HI Fenster
Janisol HI fenêtres
Janisol HI windows

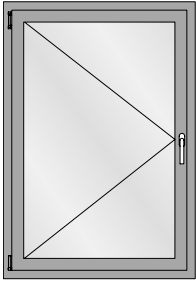

Drehflügel
 Fenêtre à la française
 Side-hung window

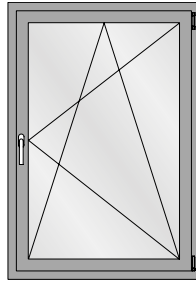

Drehkipp-Flügel
 Vantail oscillo-battant
 Turn/tilt window

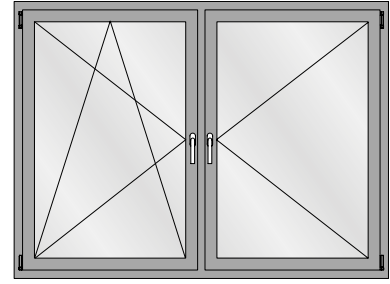

Drehkipp/Drehflügel (mit Pfosten)
 Vantail oscillo-battant/fenêtre à la française
 (avec montant)
 Side-hung/turn/tilt window (with mullion)

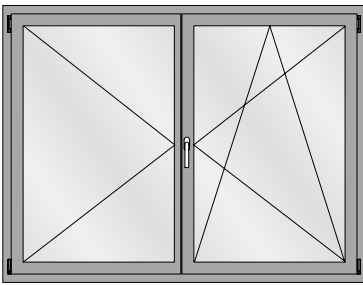

Drehkipp/Drehflügel (Stulpfenster)
 Vantail oscillo-battant/fenêtre à la française
 (Fenêtre à deux vantaux)
 Side-hung/turn/tilt window (Double-vent window)

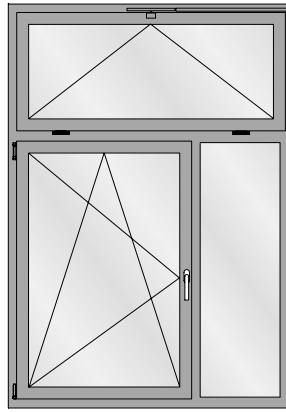

Drehkipp-Flügel mit Festverglasung und Oberlicht
 Vantail oscillo-battant avec vitrage fixe et imposte
 Turn/tilt window with fixed lights and top lights

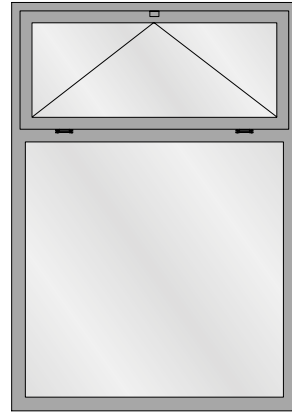

Festverglasung mit Oberlicht
 Vitrage fixe avec imposte
 Fixed lights with top light

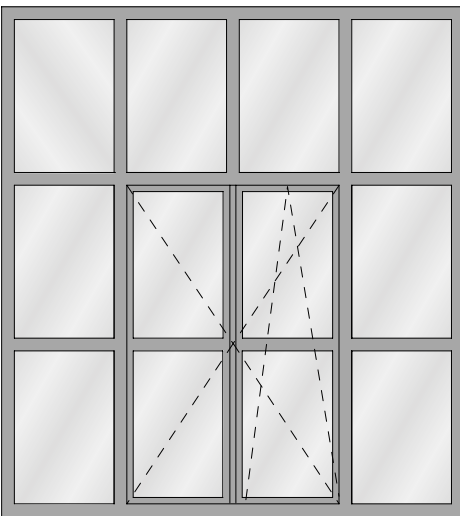

Drehkipp-Flügel mit Festverglasung
 Vantail oscillo-battant avec vitrage fixe et imposte
 Turn/tilt window with fixed lights and top lights

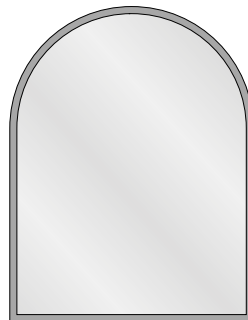

Festverglasung mit Rundbogen
 Vitrage fixe avec demi-rond
 Fixed lights with round arched

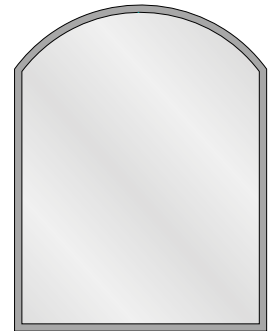
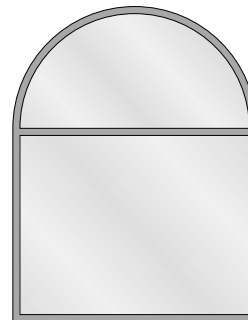

Profilübersicht
Sommaire des profilés
Summary of profiles

Janisol HI Fenster
 Janisol HI fenêtres
 Janisol HI windows

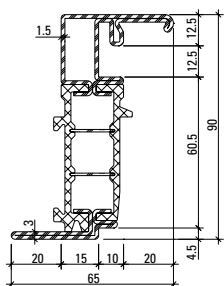

680.900 Z

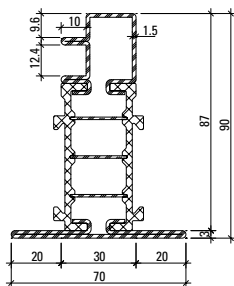

680.901 Z

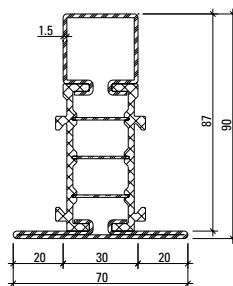

680.902 Z

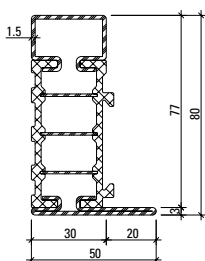

681.630 Z

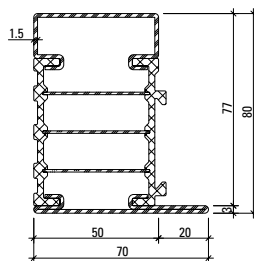

681.650 Z

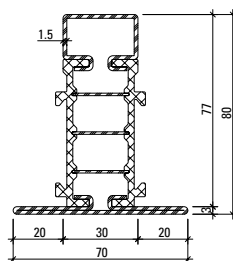

682.630 Z

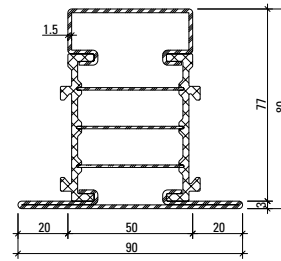

682.650 Z

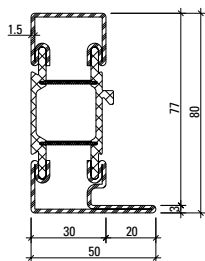

681.635 Z*

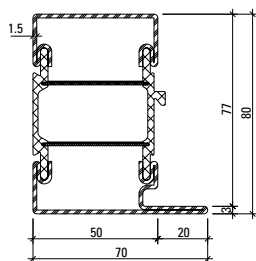

681.655 Z*

*in Kombination mit Bogen
 *en combinaison avec des cintres
 *in combination with arched design

Profil-Nr.	G kg/m	I _x cm ⁴	W _x cm ³	I _y cm ⁴	W _y cm ³	U m ² /m
681.630 Z	3,713	25,83	5,65	5,61	1,85	0,297
681.650 Z	4,331	32,30	7,21	15,97	4,04	0,337
682.630 Z	4,194	31,56	6,24	9,87	2,82	0,352
682.650 Z	4,816	38,99	7,94	24,03	5,34	0,392
680.900 Z	4,735					0,388
680.901 Z	4,618					0,390
680.902 Z	4,426	38,56	6,90	10,73	3,07	0,372
681.635 Z	3,784	26,93	5,71	7,49	2,42	0,310
681.655 Z	4,286	33,47	7,25	21,06	5,28	0,348

Artikelbibliothek
 Bibliothèque des articles
 Article library

DXF **DWG**

Profilübersicht
Sommaire des profilés
Summary of profiles

Janisol HI Fenster
 Janisol HI fenêtres
 Janisol HI windows

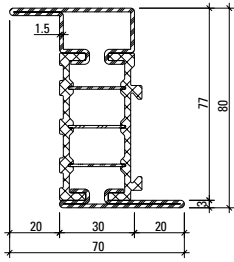

683.630 Z

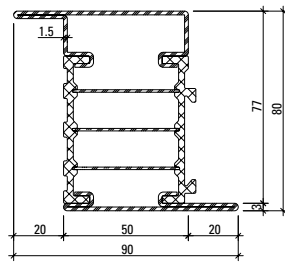

683.650 Z

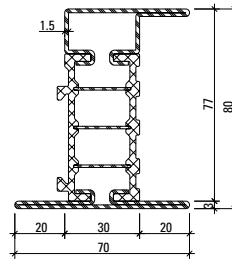

685.630 Z

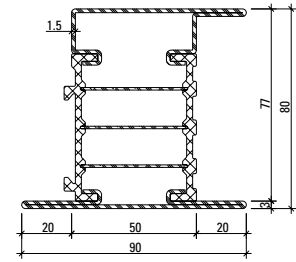

685.650 Z

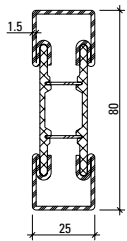

600.012
600.012 Z

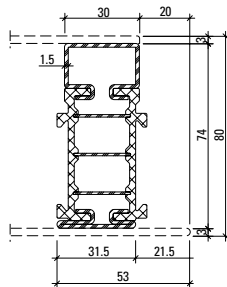

680.060 Z



Werkstoffe

Artikel-Nr.

ohne Zusatz = blank

mit Z = bandverzinkter Stahl

Isolator = glasfaserverstärkter Kunststoff

Matériaux

No. d'article

sans supplément = brut

avec Z = bande d'acier zinguée

Isolateur = matière plastique renforcé par fibres de verre

Materials

Part no.

without addition = bright

with Z = strip galvanised steel

Insulator = glassfibre reinforced plastic

Profil-Nr.	G kg/m	Ix cm ⁴	Wx cm ³	Iy cm ⁴	Wy cm ³	U m ² /m
683.630 Z	4,170	32,73	7,98	10,09	2,88	0,336
683.650 Z	4,787	38,93	9,50	24,43	5,42	0,376
685.630 Z	4,637	38,31	8,65	13,46	3,51	0,374
685.650 Z	5,258	47,62	10,93	30,13	6,14	0,415
600.012	3,254	19,67	4,92	2,93	2,34	0,224
680.060 Z	3,214	17,21	4,55	2,54	1,48	0,266

Bogenfenster
Fenêtres cintrées
Arched windows

Janisol HI Fenster
 Janisol HI fenêtres
 Janisol HI windows

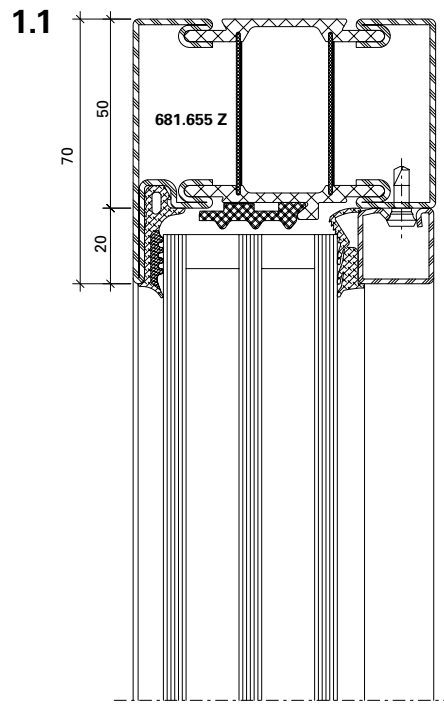
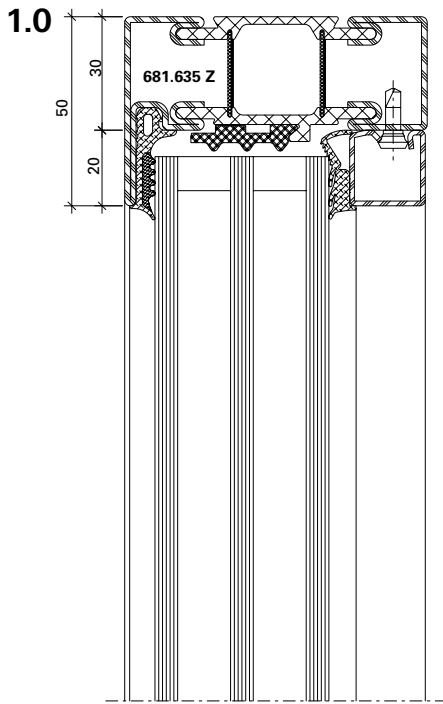
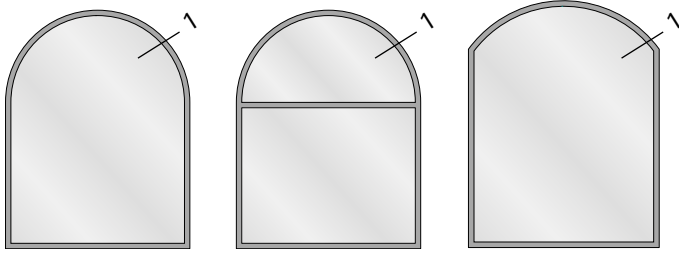

Profil	Min. Radius
Profilé	Rayon min.
Profile	Min. radius
	R

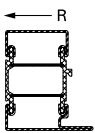

681.635 Z	700 mm
681.655 Z	750 mm

Andere Profiltypen sowie im Grundriss gebogene Profile auf Anfrage.

Autres types de profilés et profilés au tracé cintré sur demande.

Die Radien-Angaben beziehen sich auf die Fertigung im Hause Jansen.

Les rayons indiqués concernent la fabrication des cintres par la société Jansen.

Stahl-Glasleisten	Min. Radius
Parcloses en acier	Rayon min.
Steel glazing beads	Min. radius
	R



402.112 Z	500 mm
402.115 Z	500 mm
402.120 Z	600 mm
402.125 Z	750 mm
402.130 Z	1000 mm
402.136 Z	500 mm
402.141 Z	500 mm

Stahl-Glasleisten	Min. Radius
Parcloses en acier	Rayon min.
Steel glazing beads	Min. radius
	R



62.507 Z	300 mm
62.508 Z	300 mm
62.509 Z	300 mm

Aluminium-Glasleisten	Min. Radius
Parcloses en aluminium	Rayon min.
Aluminium glazing beads	Min. radius
	R



404.112	400 mm
404.115	400 mm
404.120	400 mm
404.125	450 mm
404.130	500 mm
404.135	600 mm

Other profile types and profiles curved in the floor plan are available on request.

The radius information refers to the production of the arches at the Jansen.

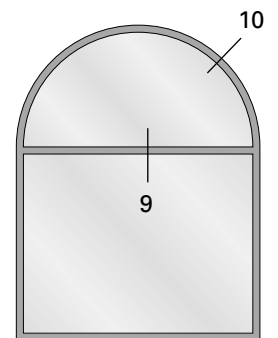
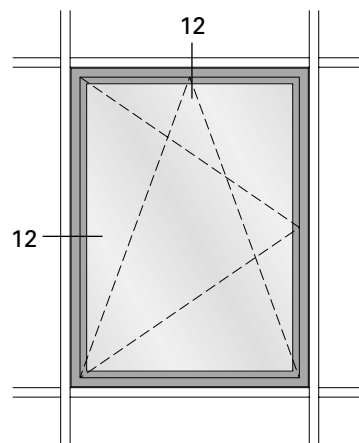
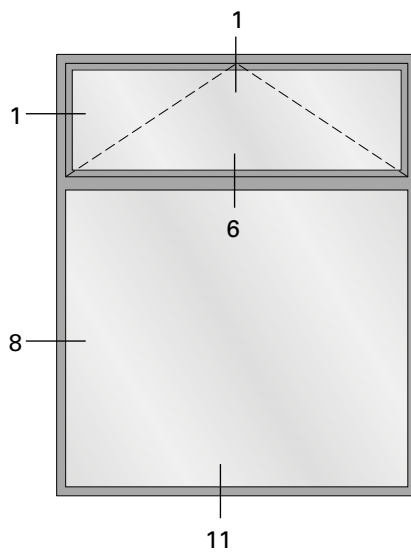
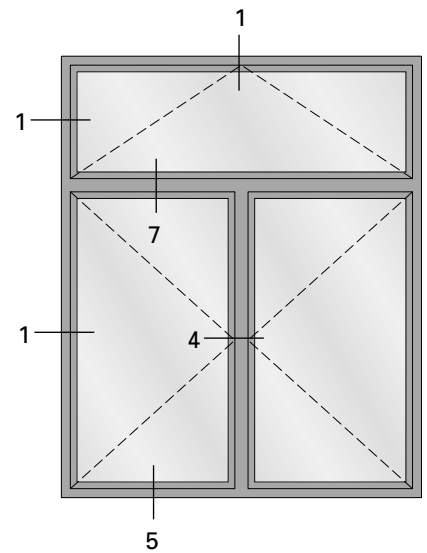
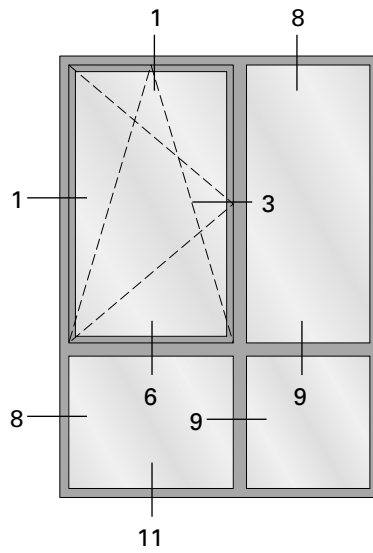
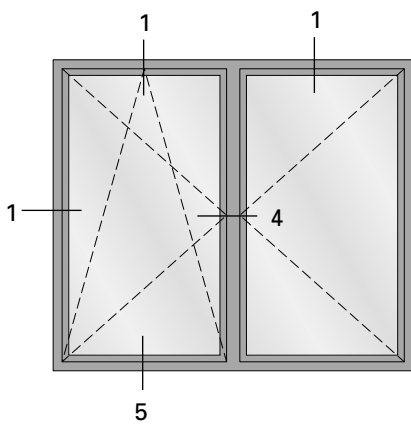
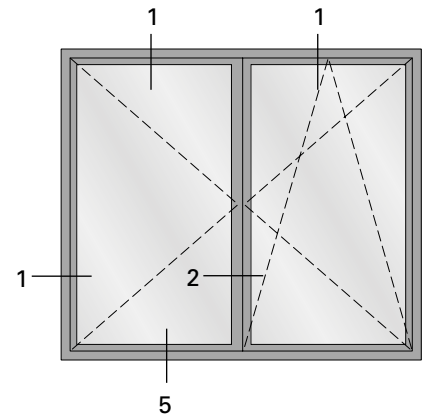
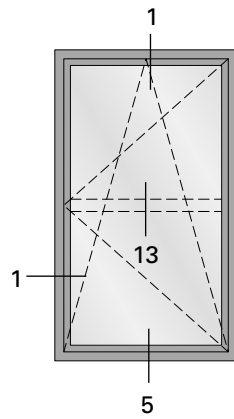
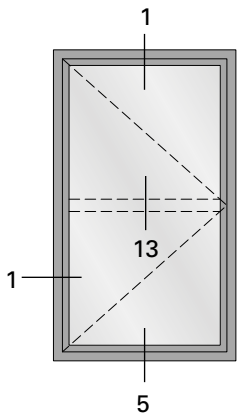

1.0

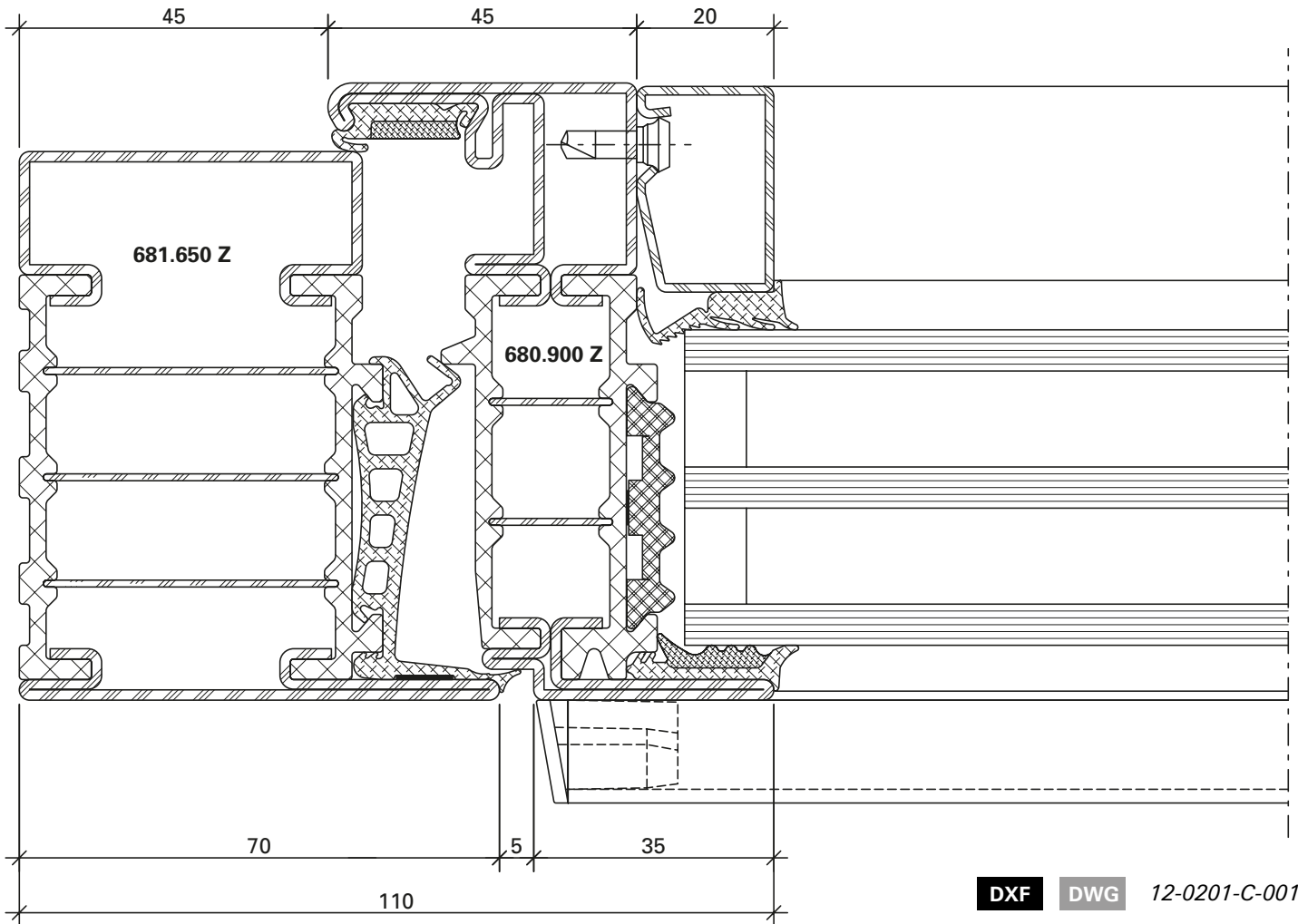

DXF

DWG

12-0201-C-001

1.1

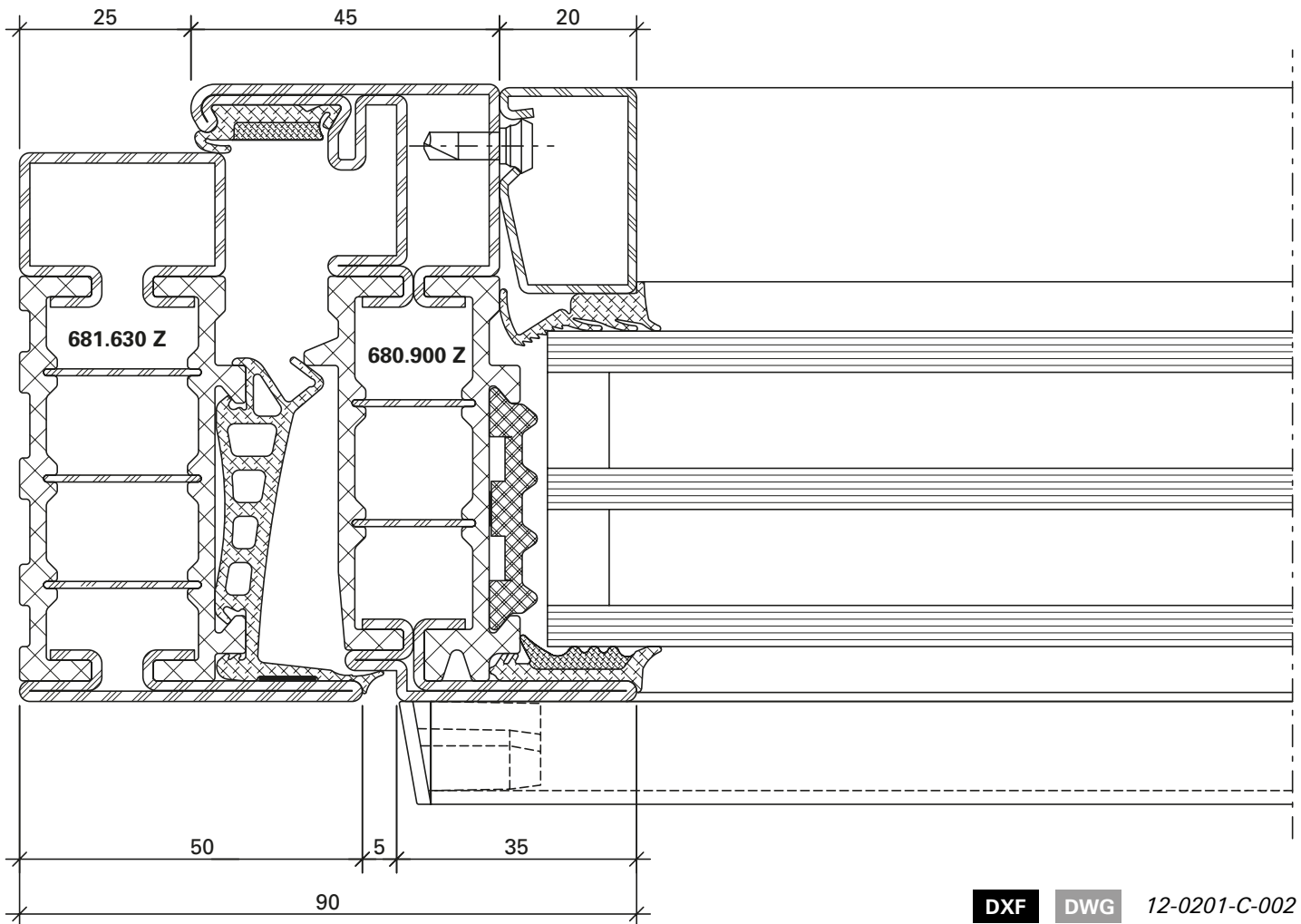

DXF

DWG

12-0201-C-002

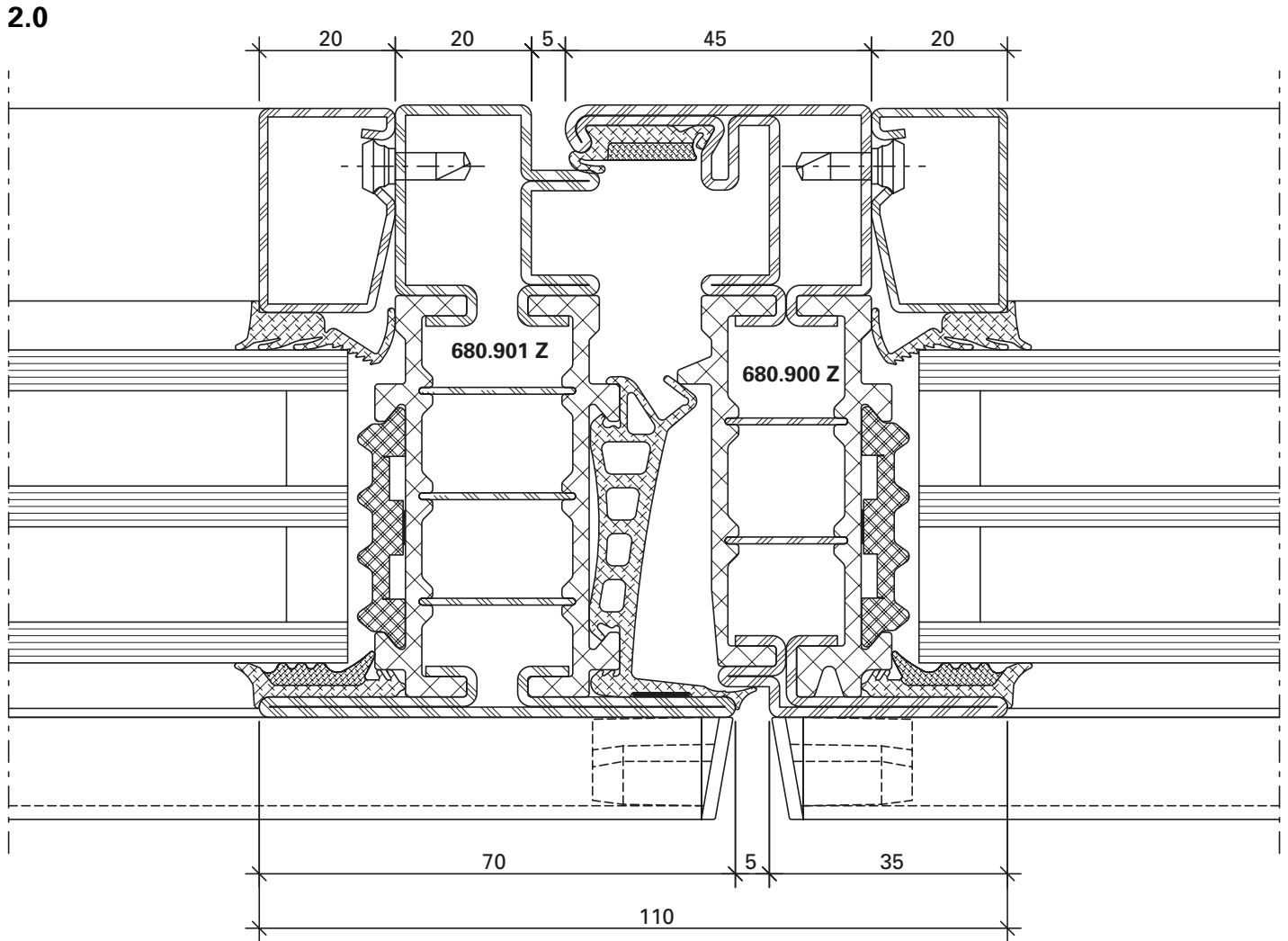

DXF DWG 12-0201-C-007

3.0

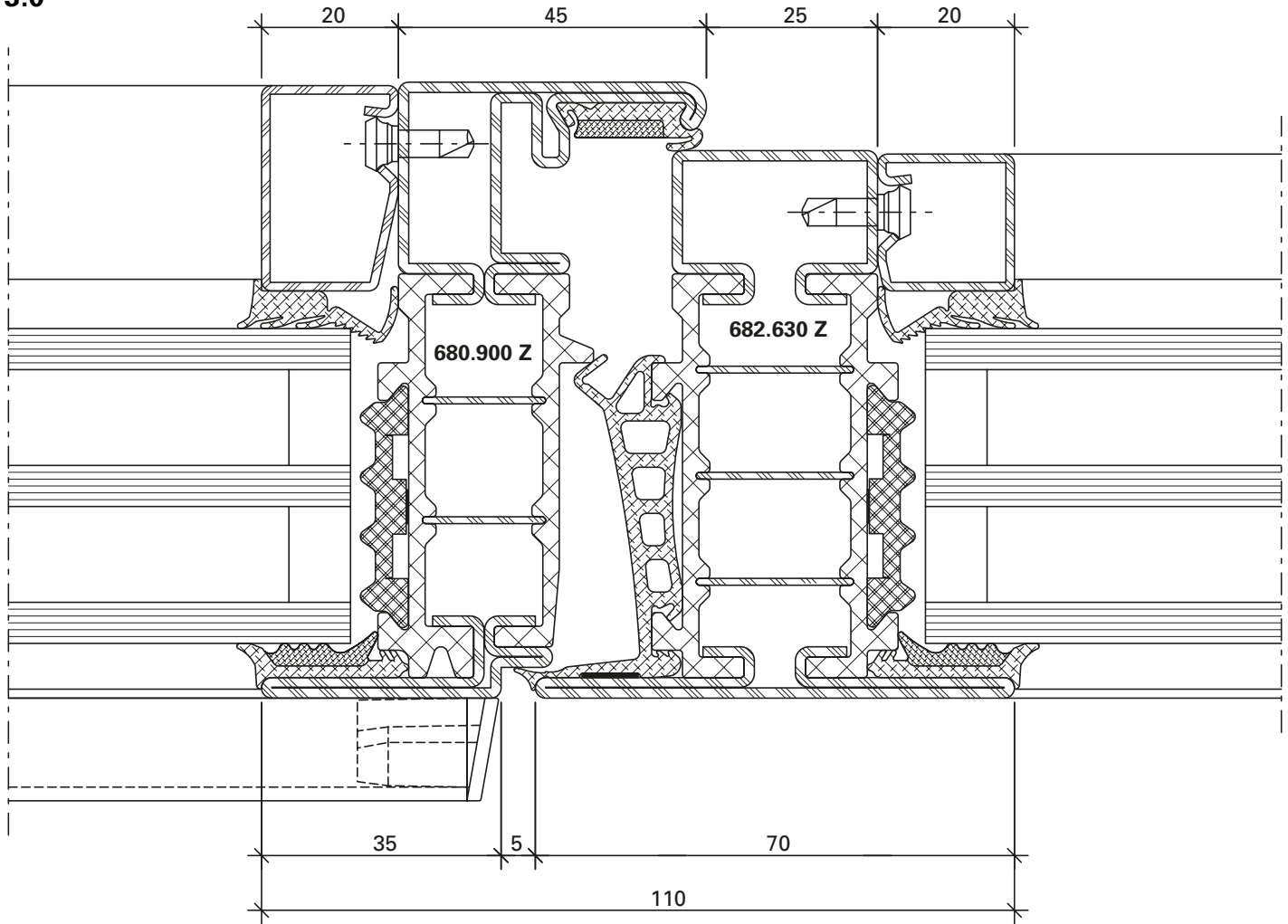

DXF

DWG

12-0201-C-004

4.0

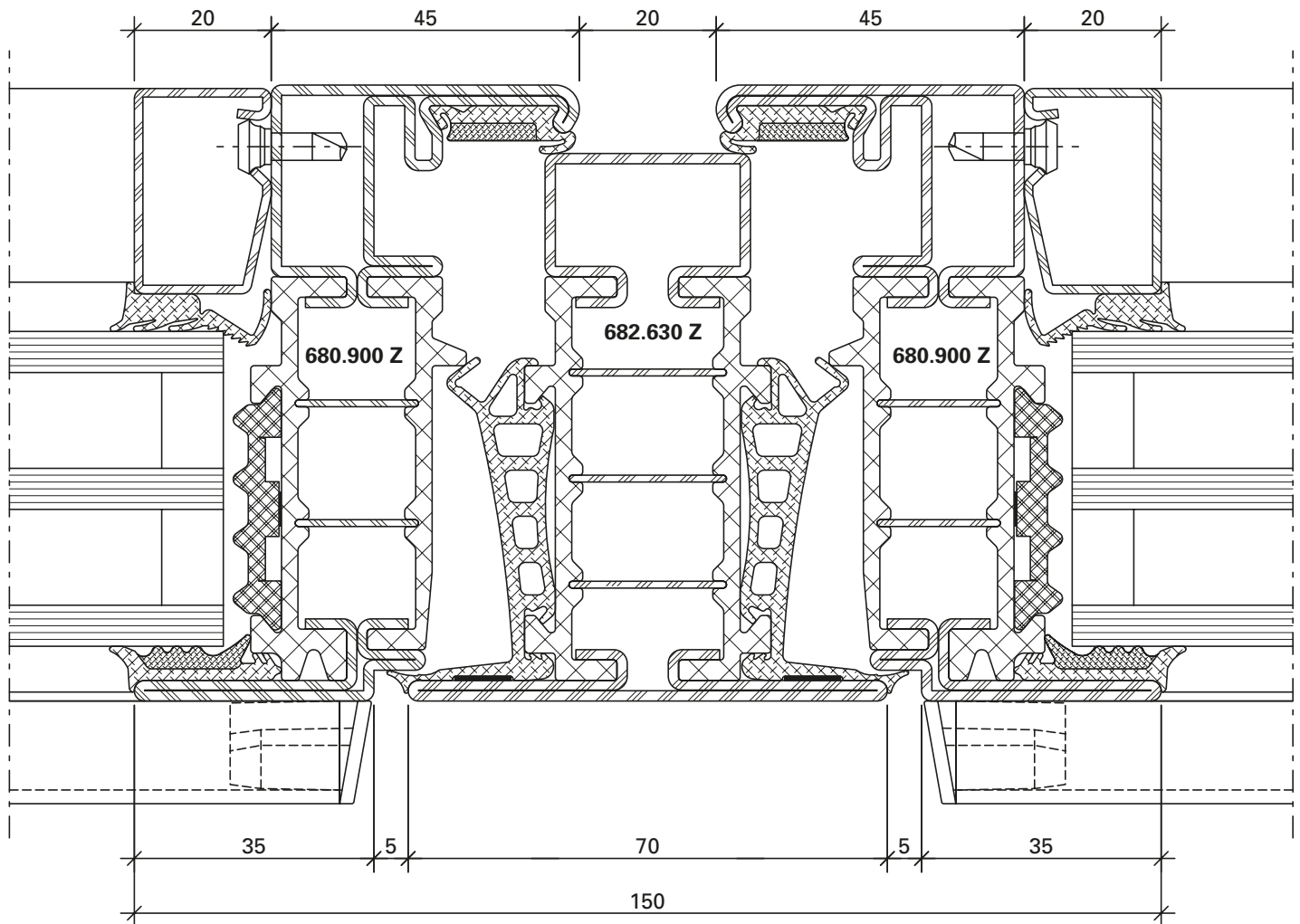

DXF DWG 12-0201-C-006

13.0

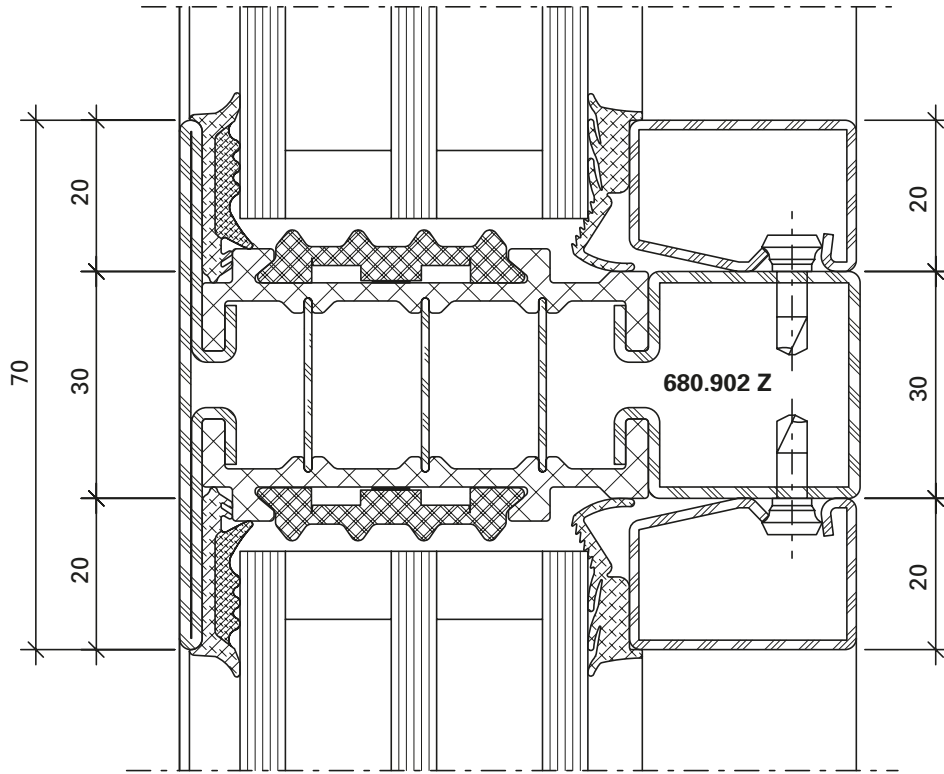

12-0201-C-020

DWG

DXF

5.0

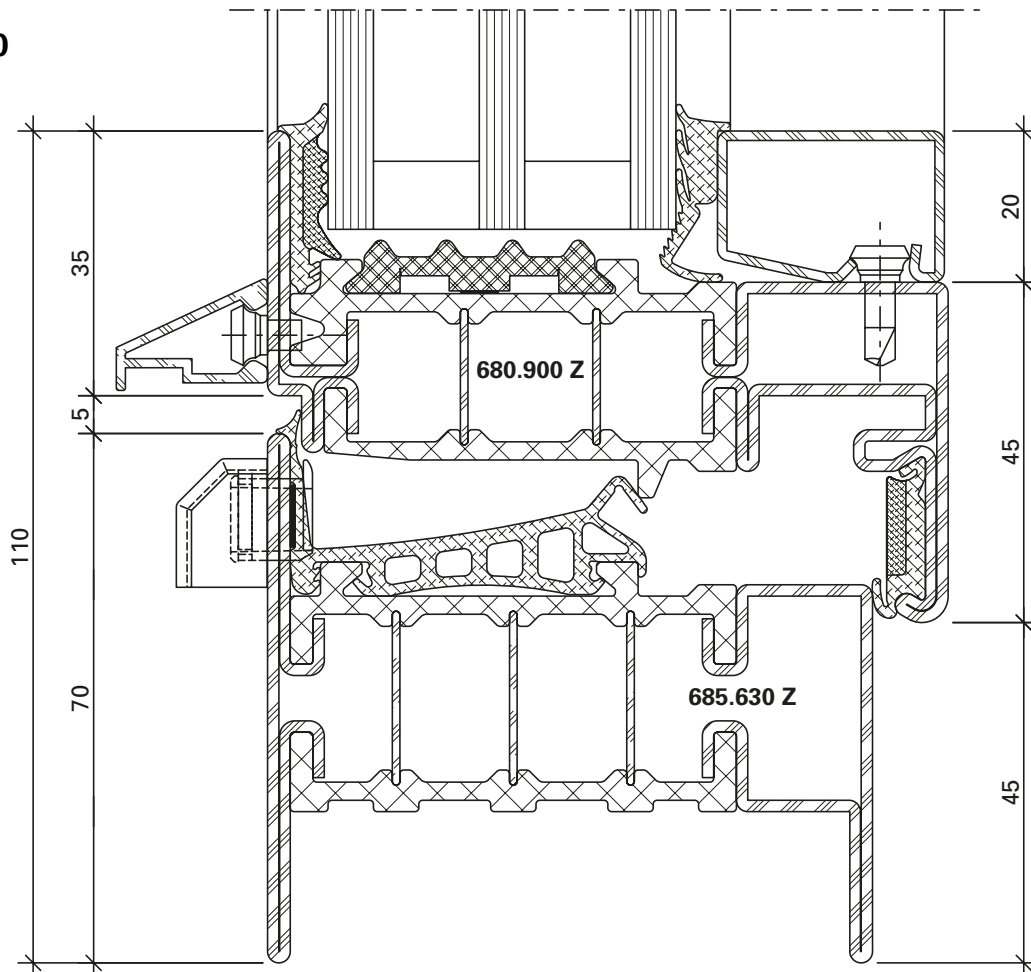

12-0201-C-009

DWG

DXF

6.0

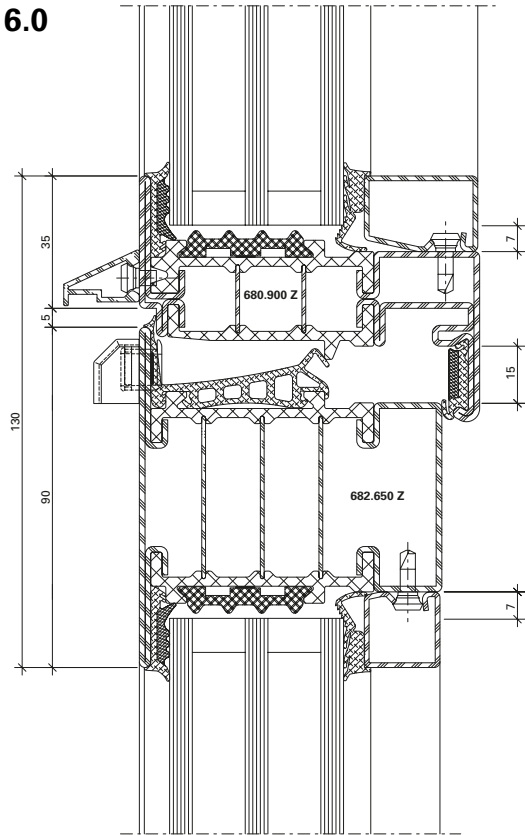

DWG 12-0201-C-016

DWG

DXF

6.1

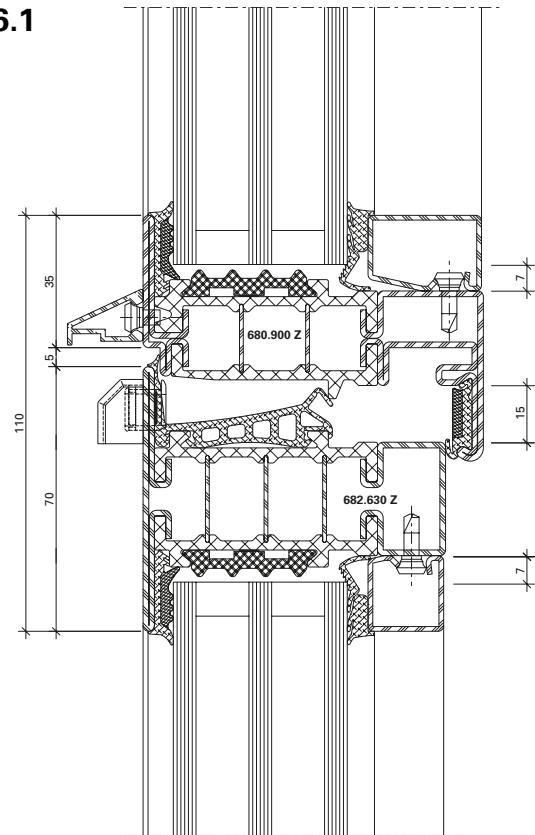

DWG 12-0201-C-019

DWG

DXF

7.0

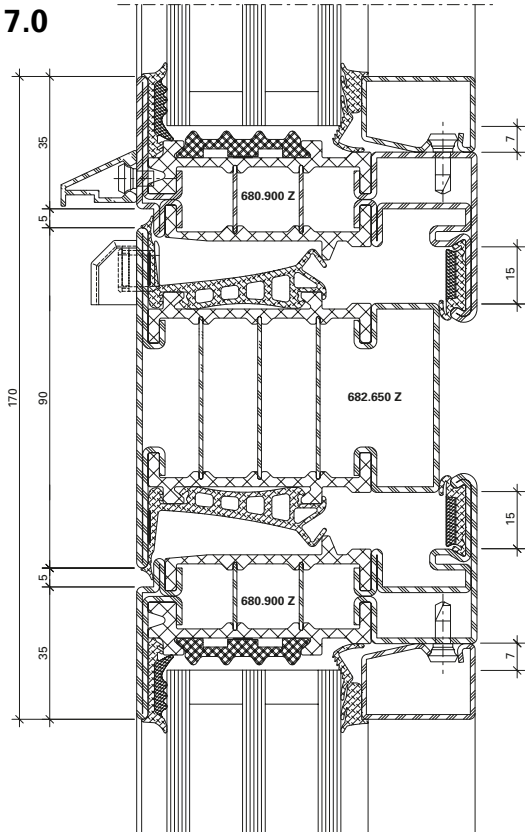

DWG 12-0201-C-018

DWG

DXF

5.1

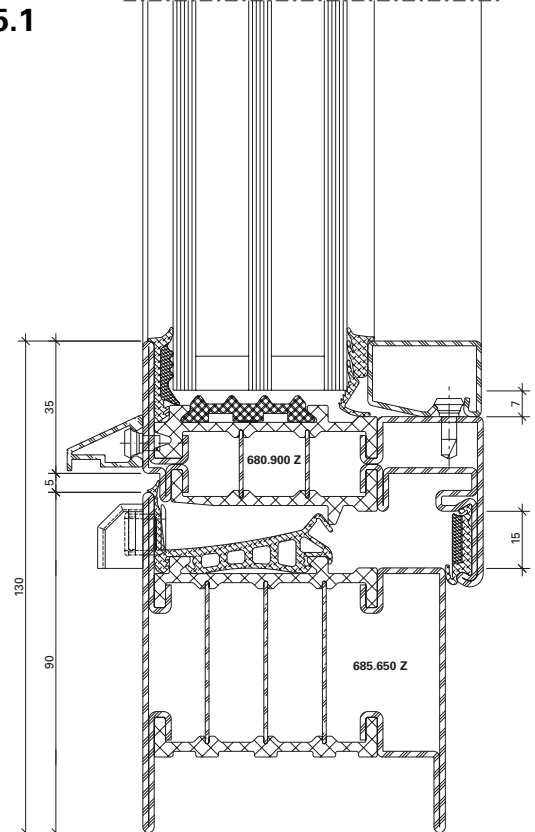

DWG 12-0201-C-008

DWG

DXF

8.0

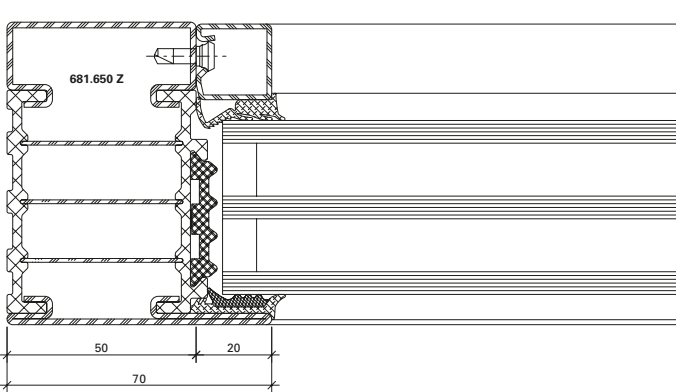

DXF

DWG

12-0201-C-012

9.0

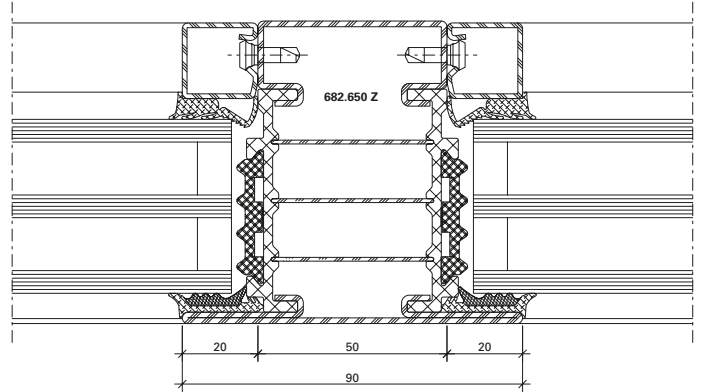

DXF

DWG

12-0201-C-014

8.1

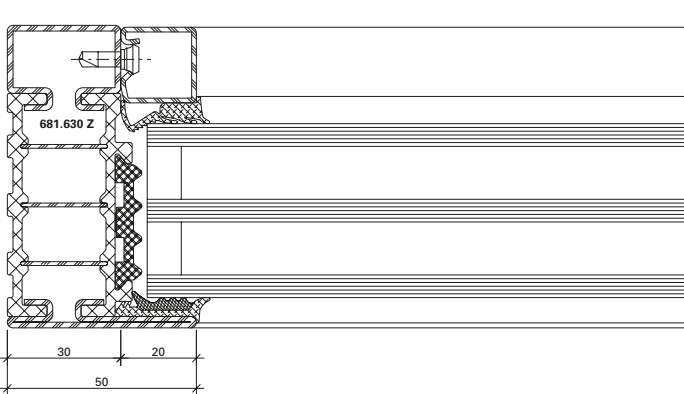

DXF

DWG

12-0201-C-013

9.1

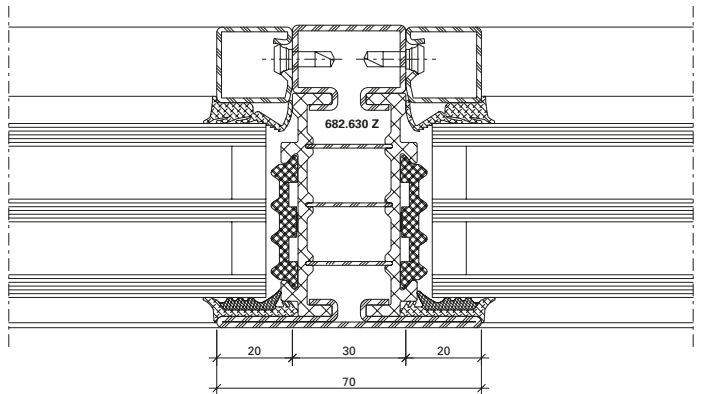

DXF

DWG

12-0201-C-015

10.0

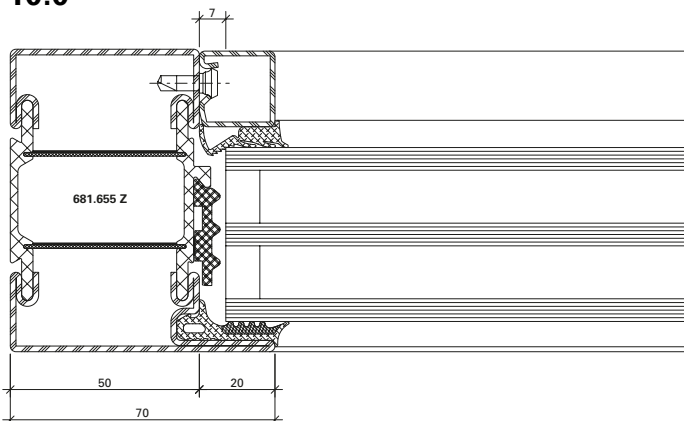

DXF

DWG

12-0204-C-003

10.1

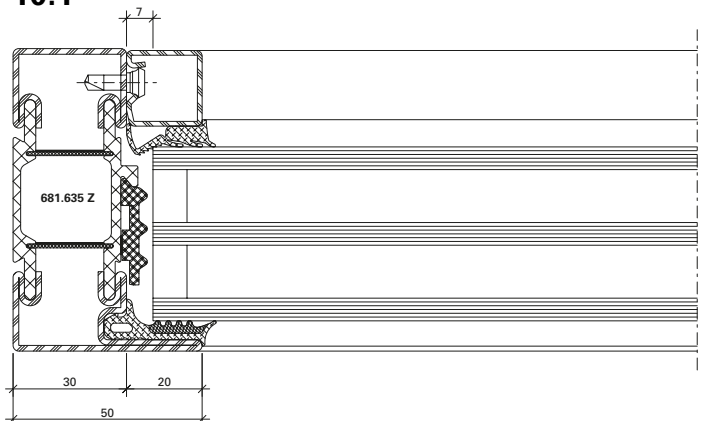

DXF

DWG

12-0204-C-004

3.1

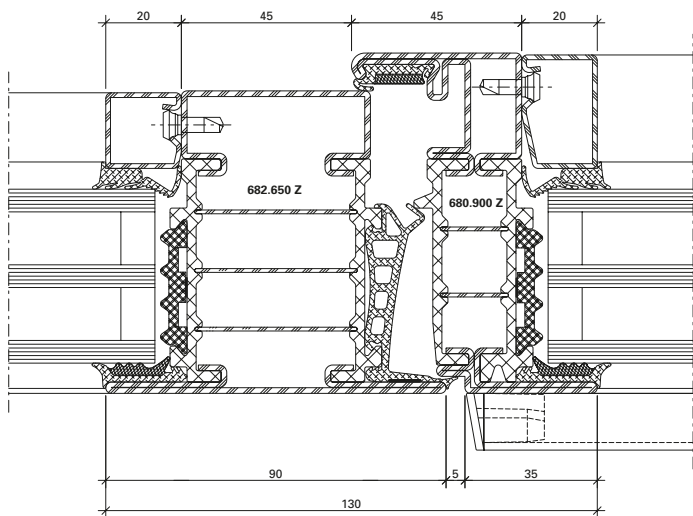

DXF **DWG** 12-0201-C-003

4.1

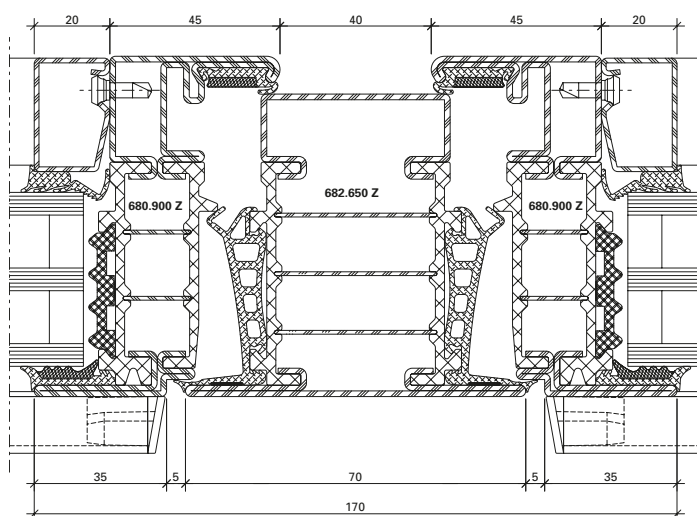

DXF **DWG** 12-0201-C-005

1.3

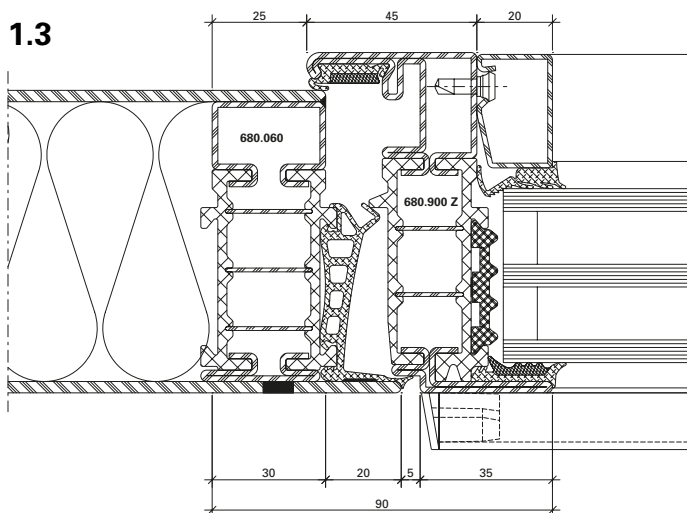

DXF **DWG** 12-0201-C-021

8.2

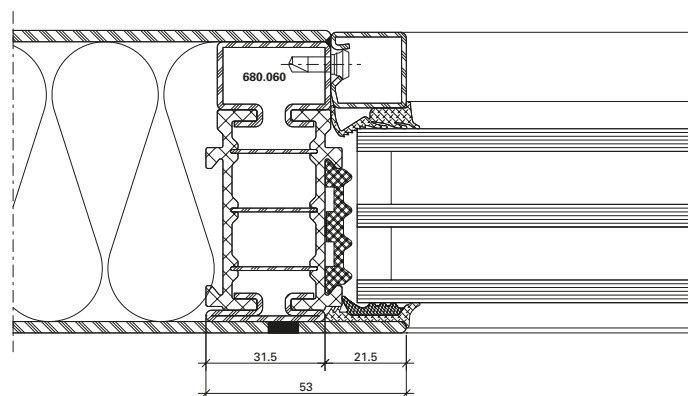

DXF **DWG** 12-0201-C-022

9.2

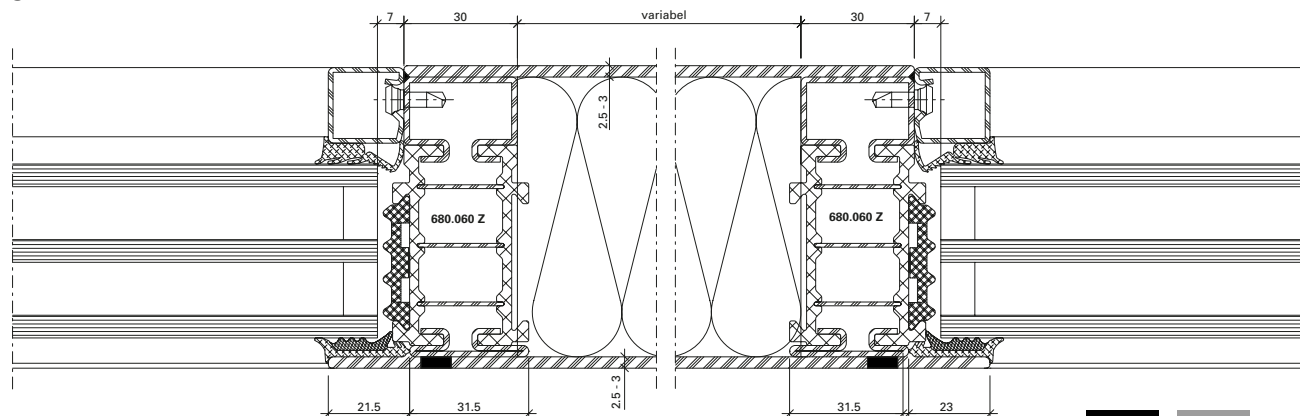

DXF **DWG** 12-0102-C-065

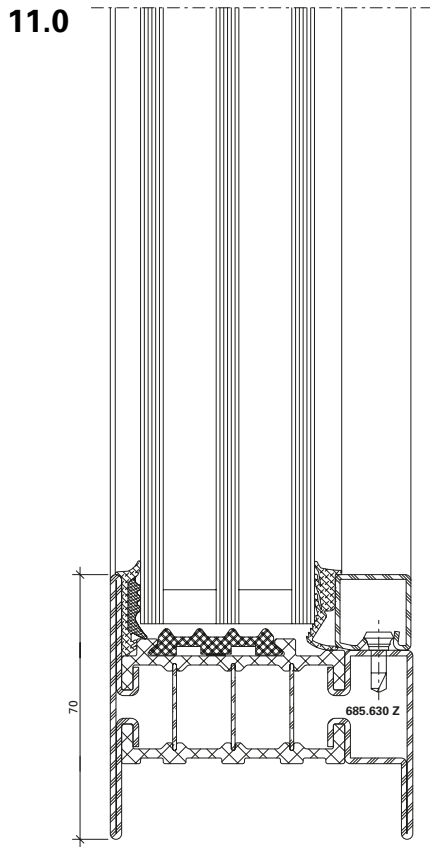

12-0201-C-011

DWG

DXF

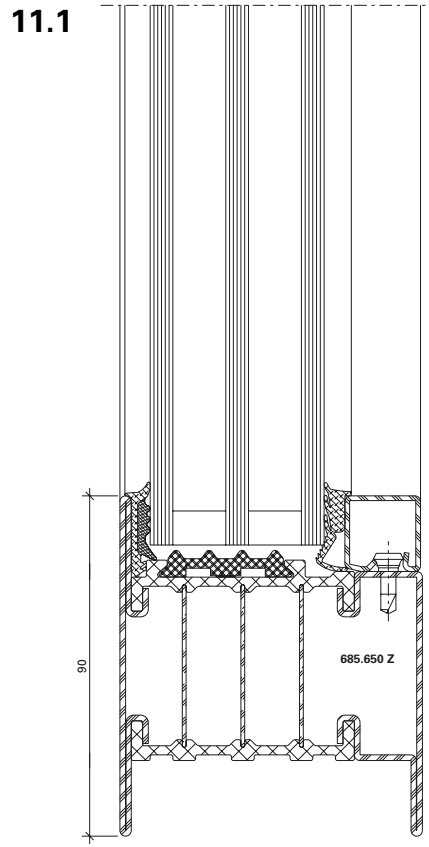

12-0201-C-010

DWG

DXF

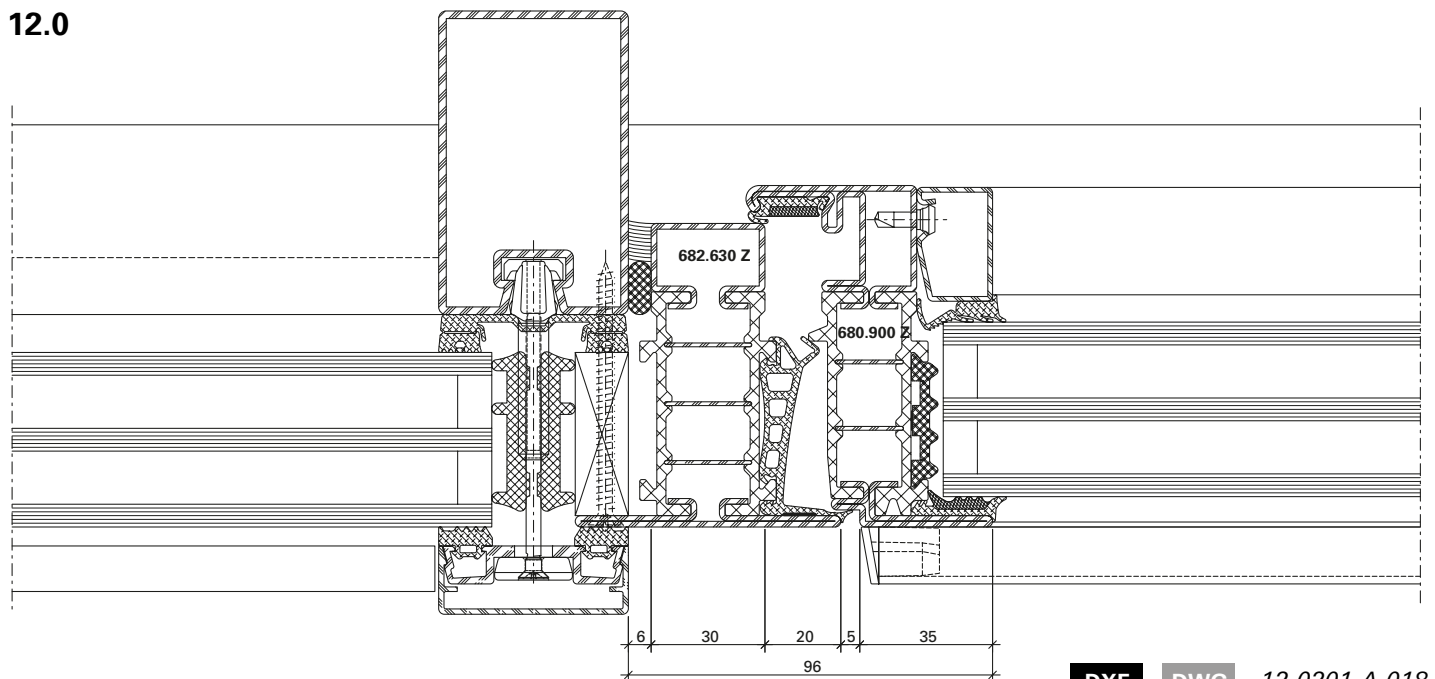

DXF

DWG

12-0201-A-018

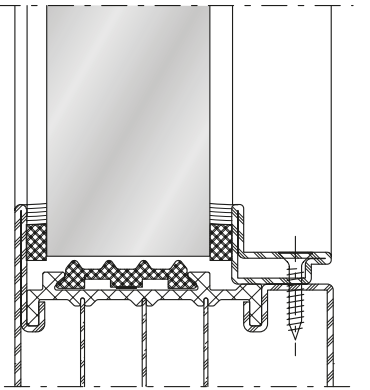
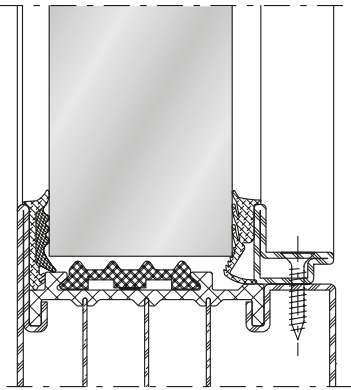
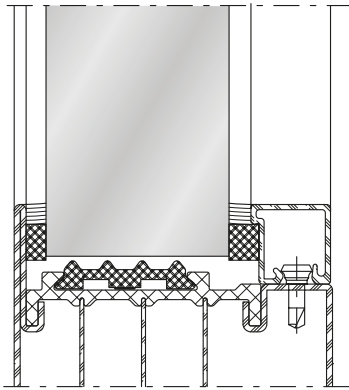
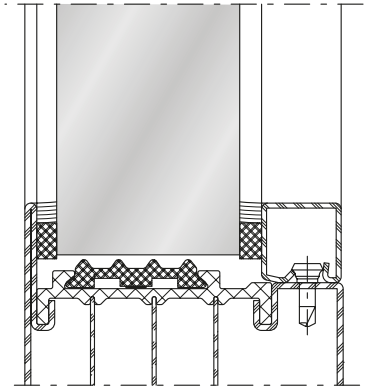
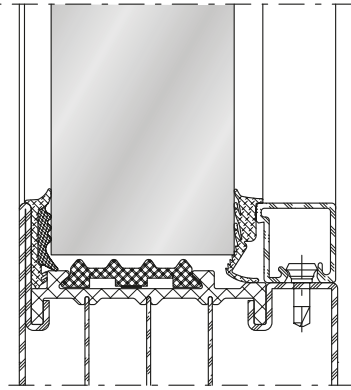
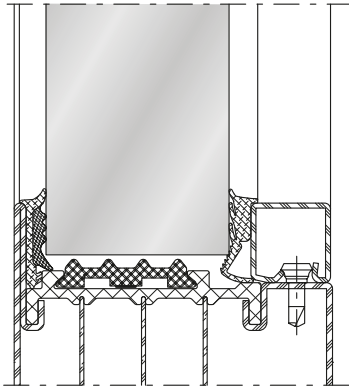

Platzbedarf
Standard-Fensterbeschlag
Bei Öffnungswinkel 90°

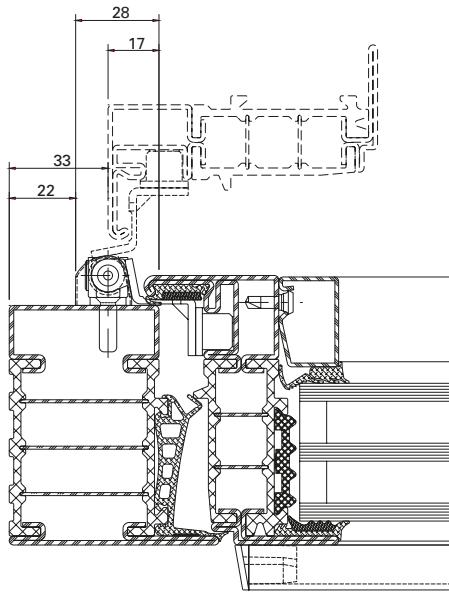

Espace nécessaire
Ferrure de fenêtre standard
À l'angle d'ouverture 90°

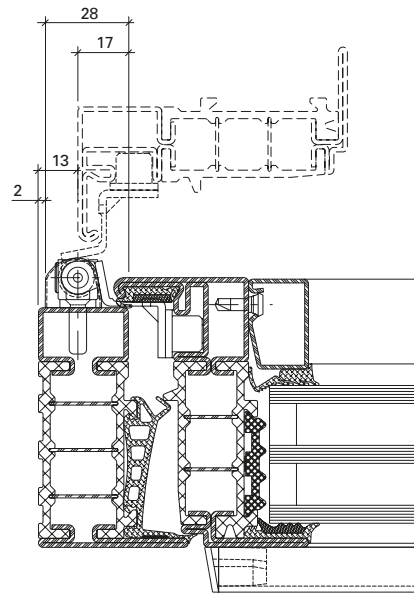

Space required
Standard window fitting
At opening angle 90°

Platzbedarf
Verdeckt liegender Fensterbeschlag
Bei Öffnungswinkel 90°

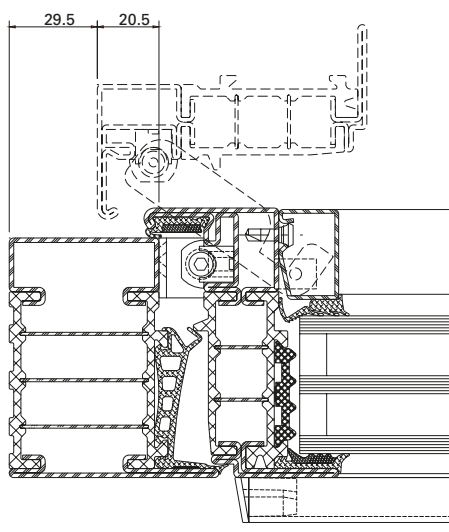

Espace nécessaire
Ferrure de fenêtre non apparente
À l'angle d'ouverture 90°

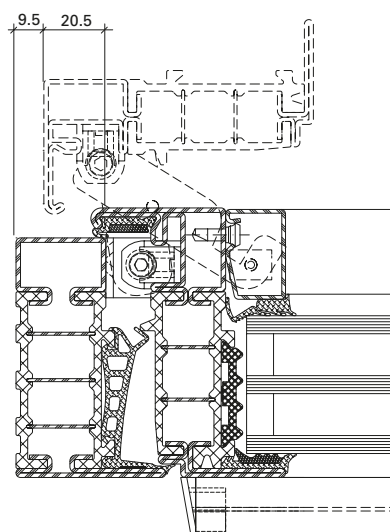

Space required
Concealed window fitting
At opening angle 90°

Platzbedarf
Standard-Fensterbeschlag
Bei Öffnungswinkel 90°

Espace nécessaire
Ferrure de fenêtre standard
À l'angle d'ouverture 90°

Space required
Standard window fitting
At opening angle 90°

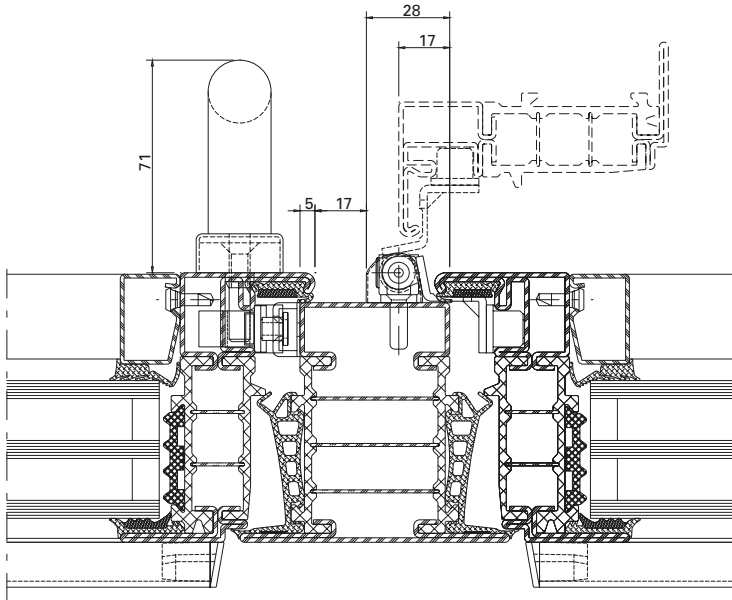

Platzbedarf
Verdeckt liegender Fensterbeschlag
Bei Öffnungswinkel 90°

Espace nécessaire
Ferrure de fenêtre non apparente
À l'angle d'ouverture 90°

Space required
Concealed window fitting
At opening angle 90°

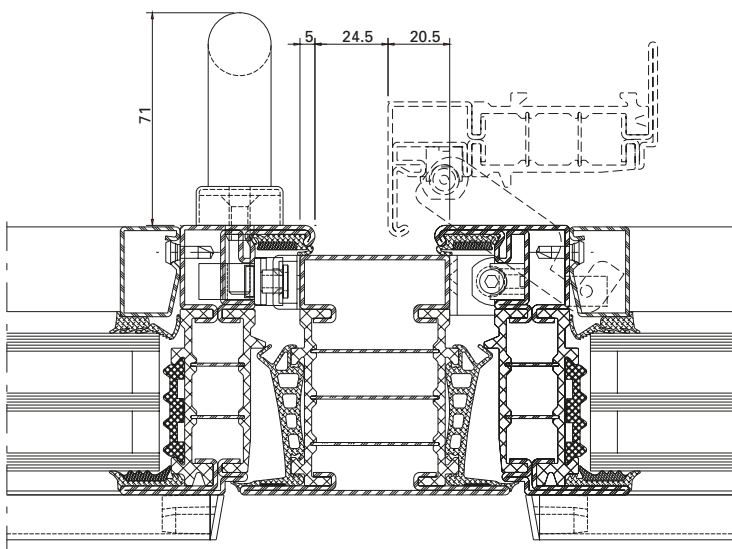

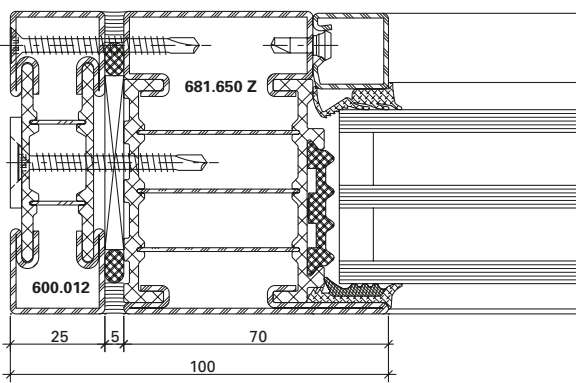

DXF **DWG** 12-0201-K-001

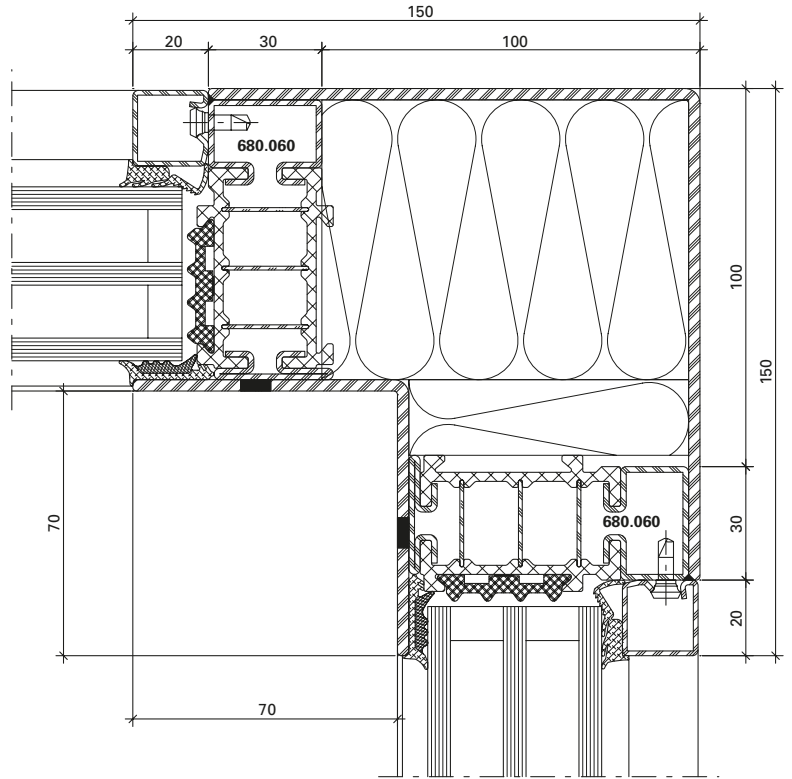

DXF **DWG** 12-0201-K-005

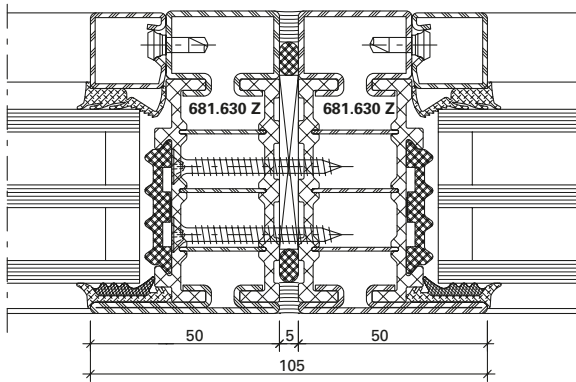

DXF **DWG** 12-0201-K-002

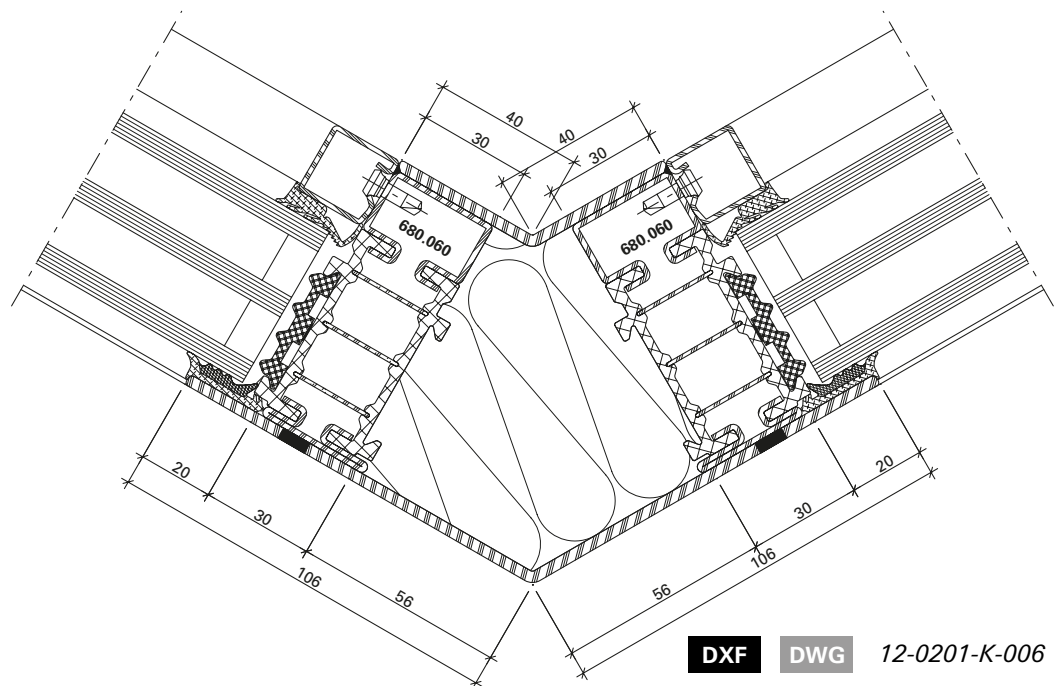

DXF **DWG** 12-0201-K-006

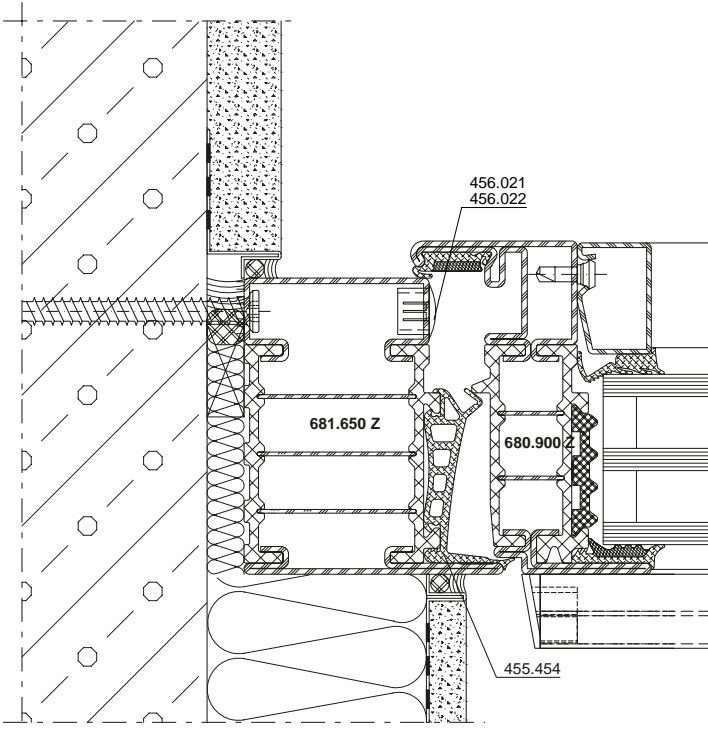

DXF **DWG** 12-0201-A-037

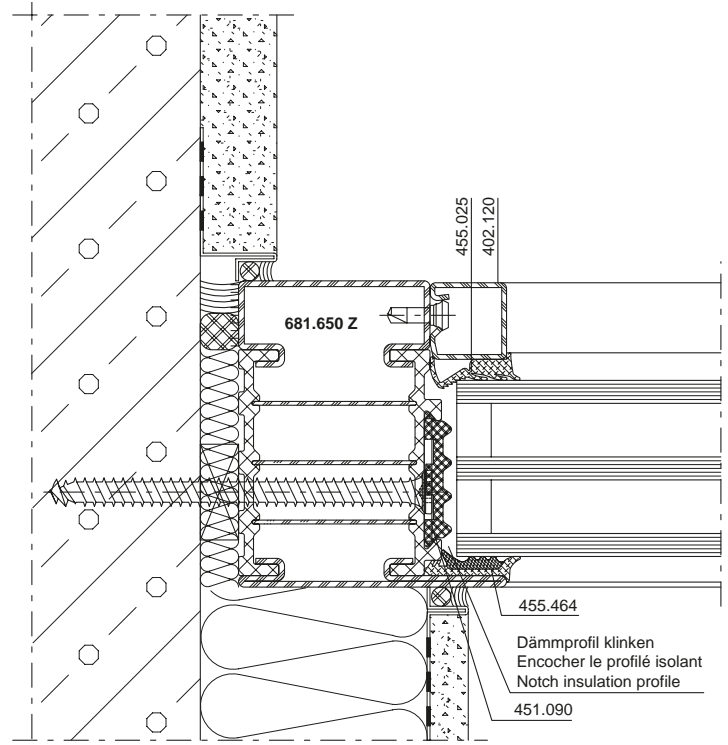

DXF **DWG** 12-0201-A-038

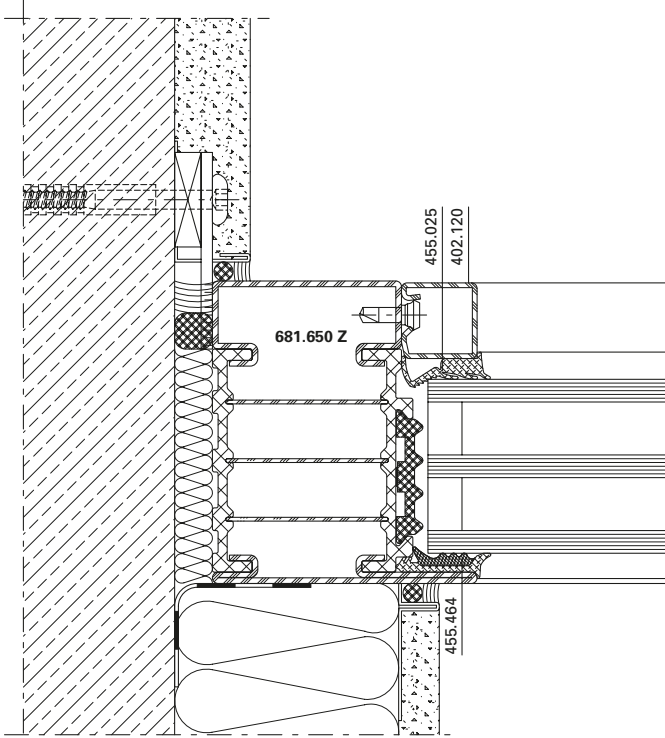

DXF DWG 12-0201-A-002

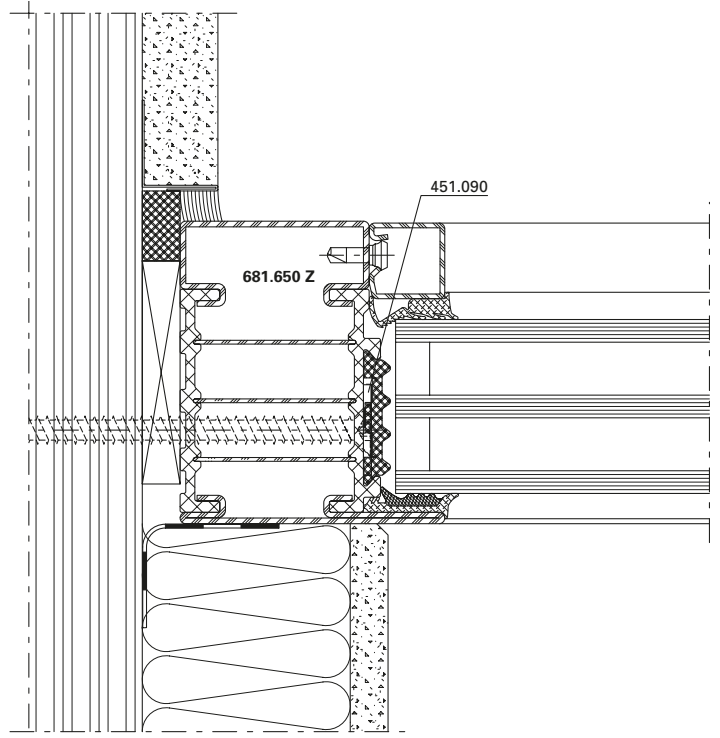

DXF DWG 12-0201-A-016

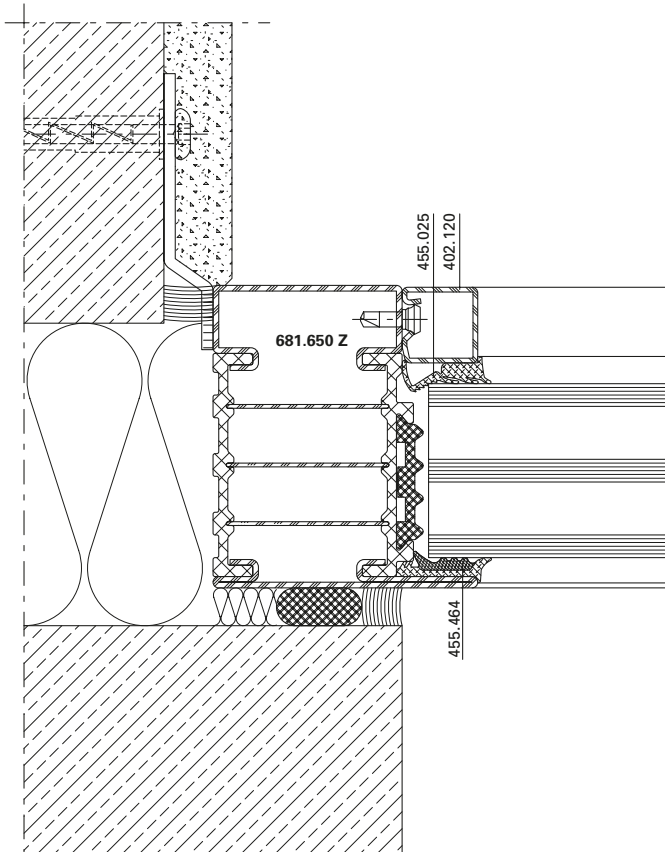

DXF DWG 12-0201-A-004

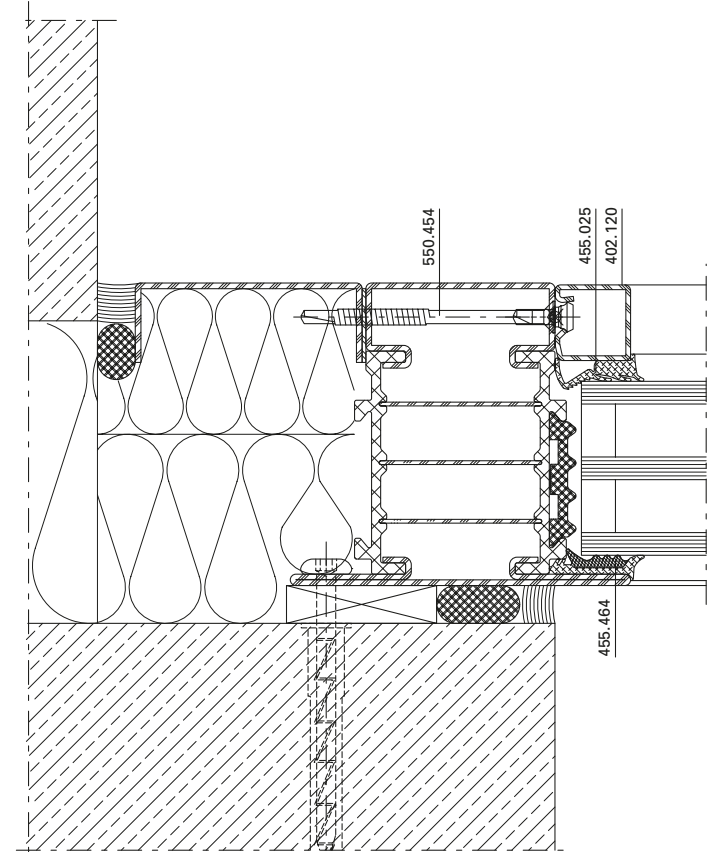

DXF DWG 12-0201-A-005

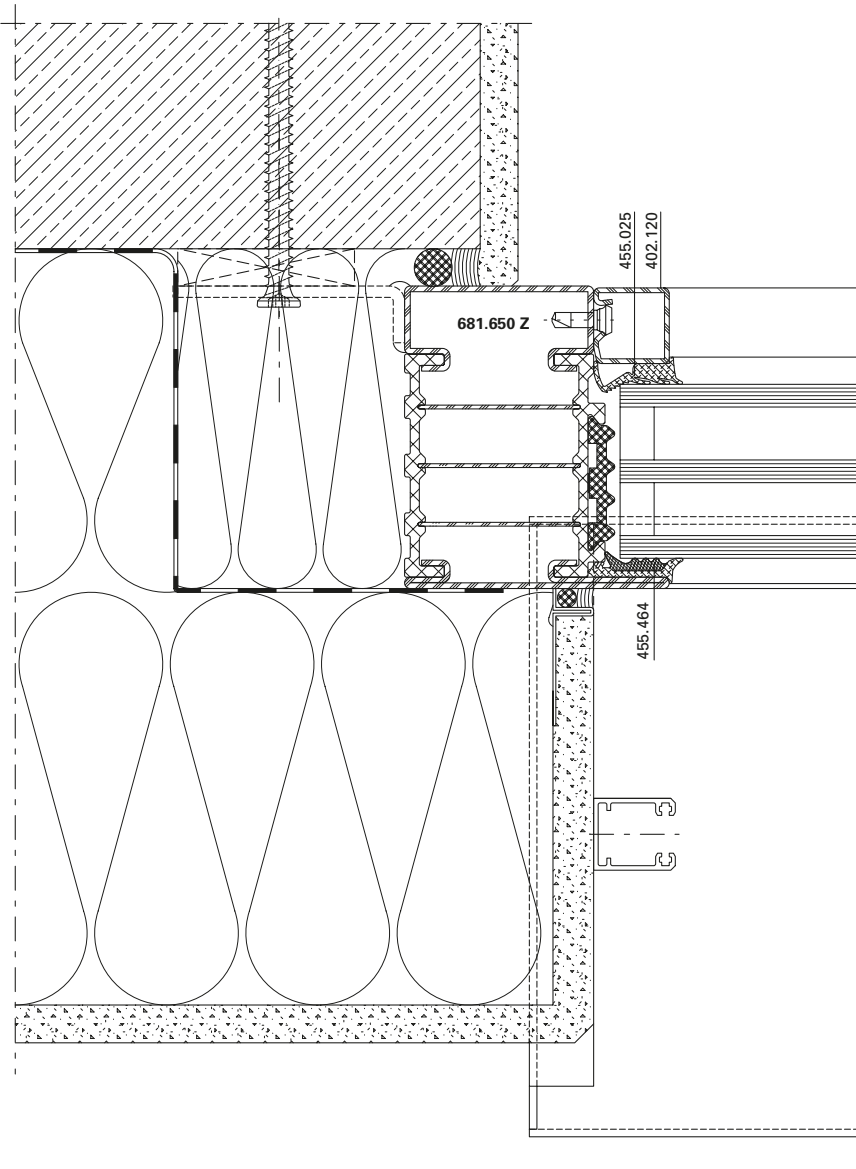

DXF **DWG** 12-0201-A-001

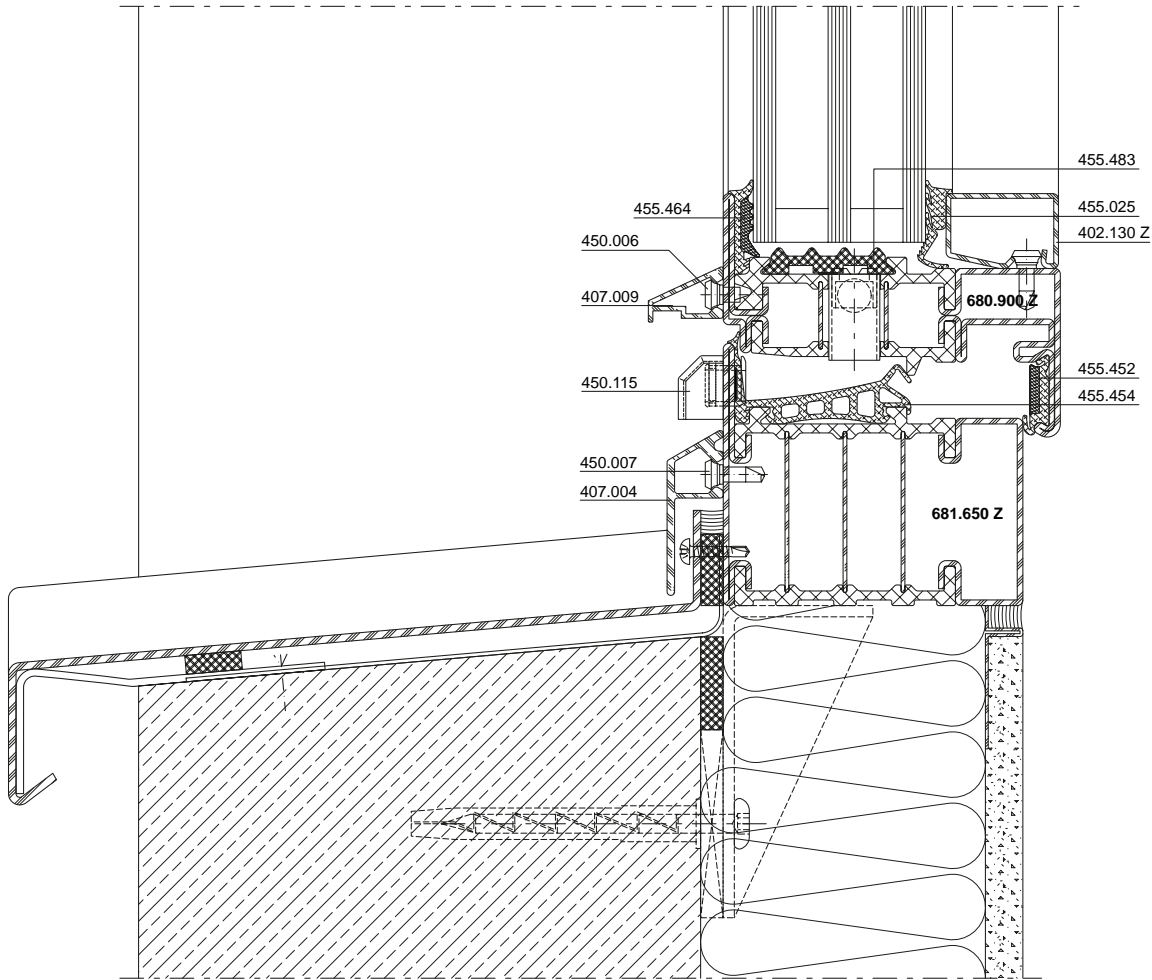

DXF

DWG

12-0201-A-014

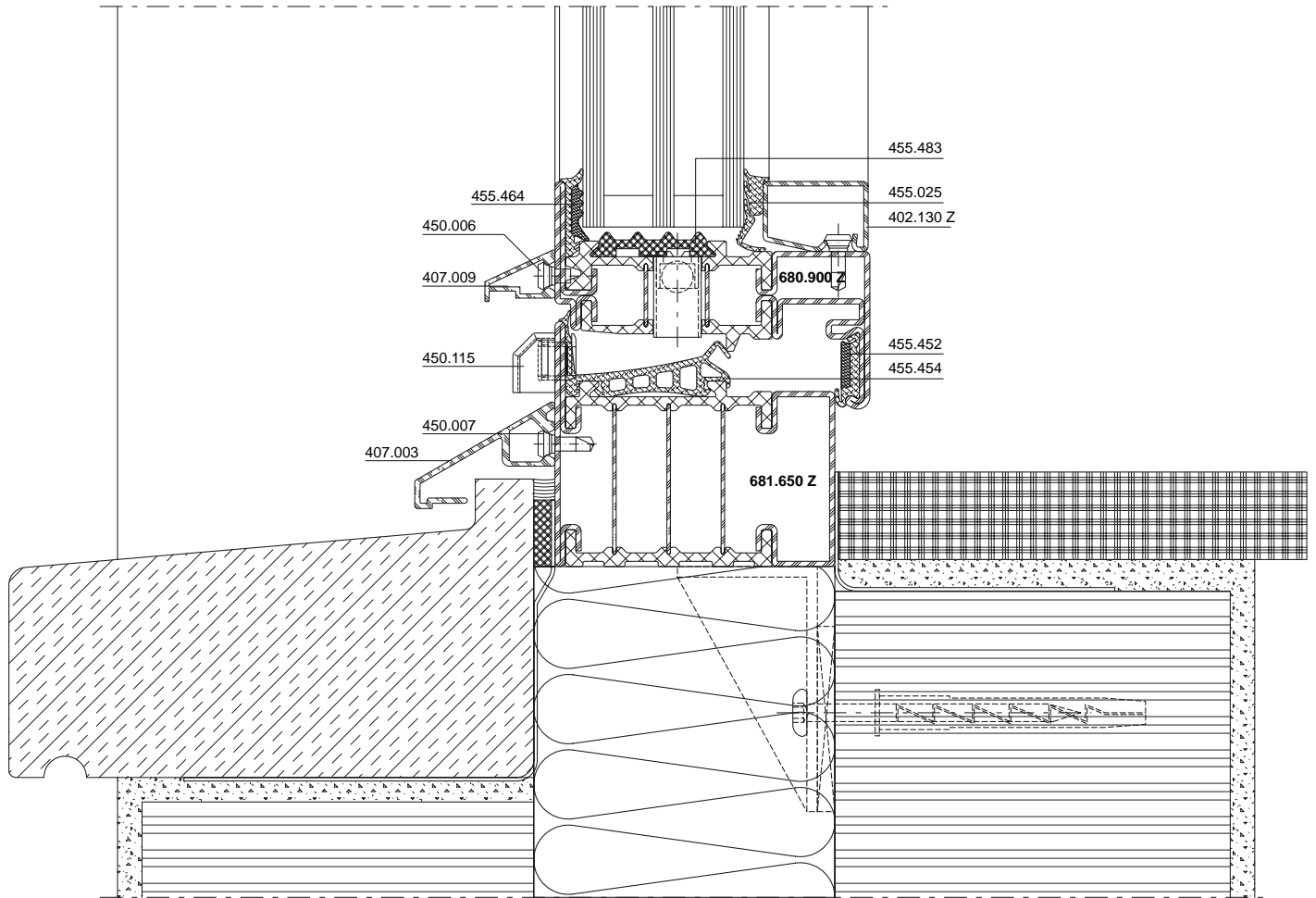

DXF DWG 12-0201-A-012

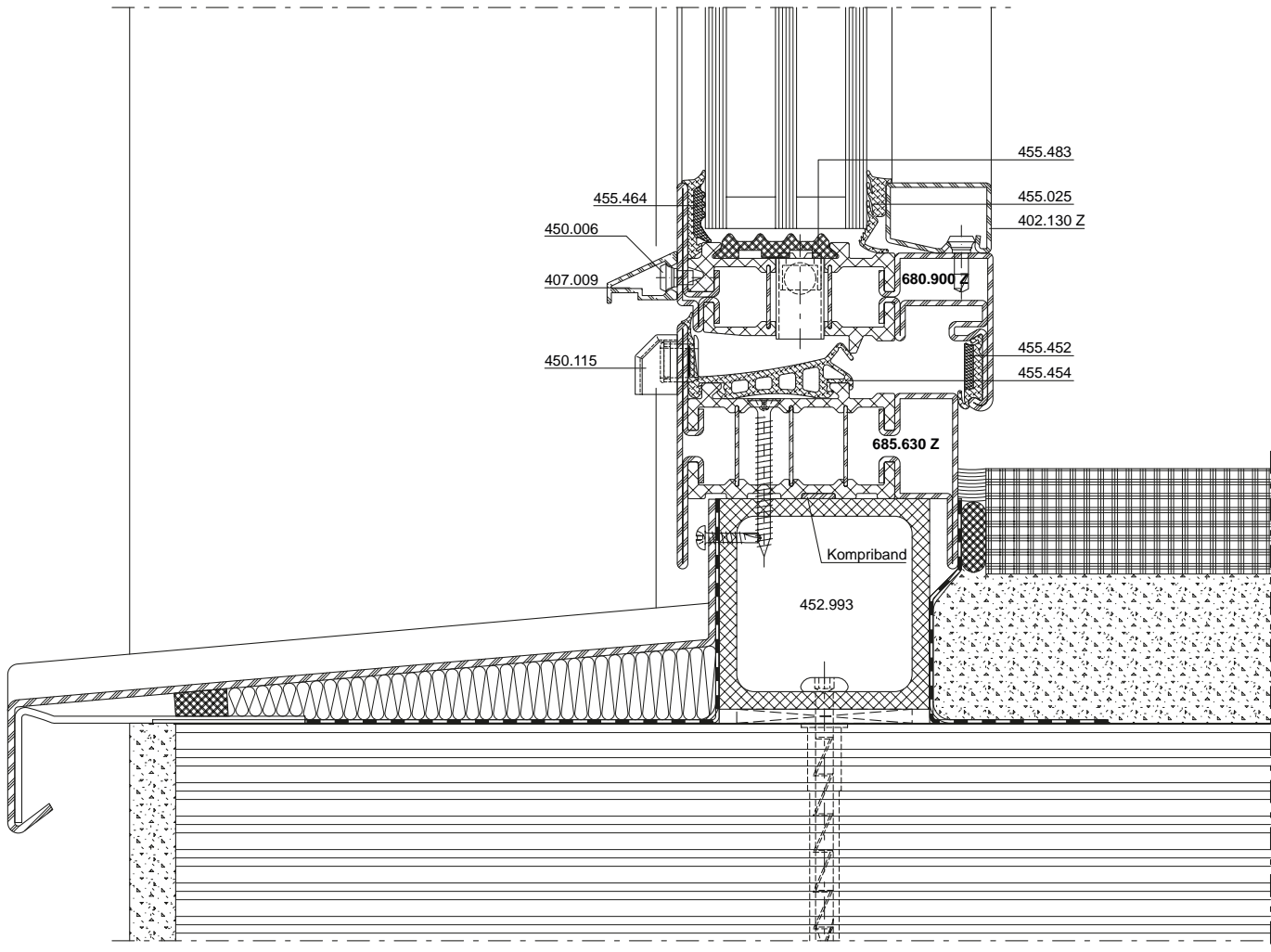

DXF DWG 12-0201-A-015

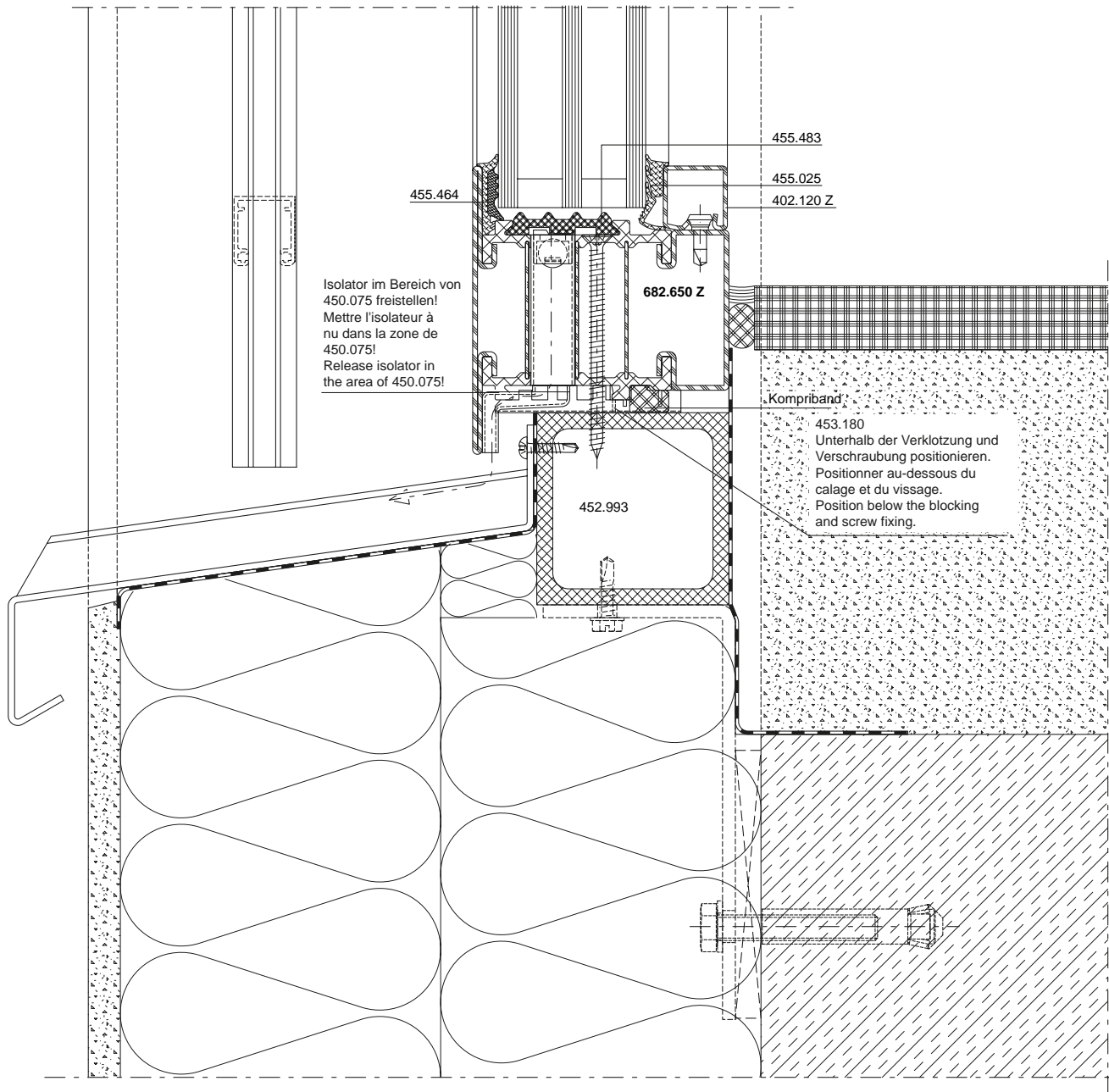

DXF

DWG

12-0201-A-006

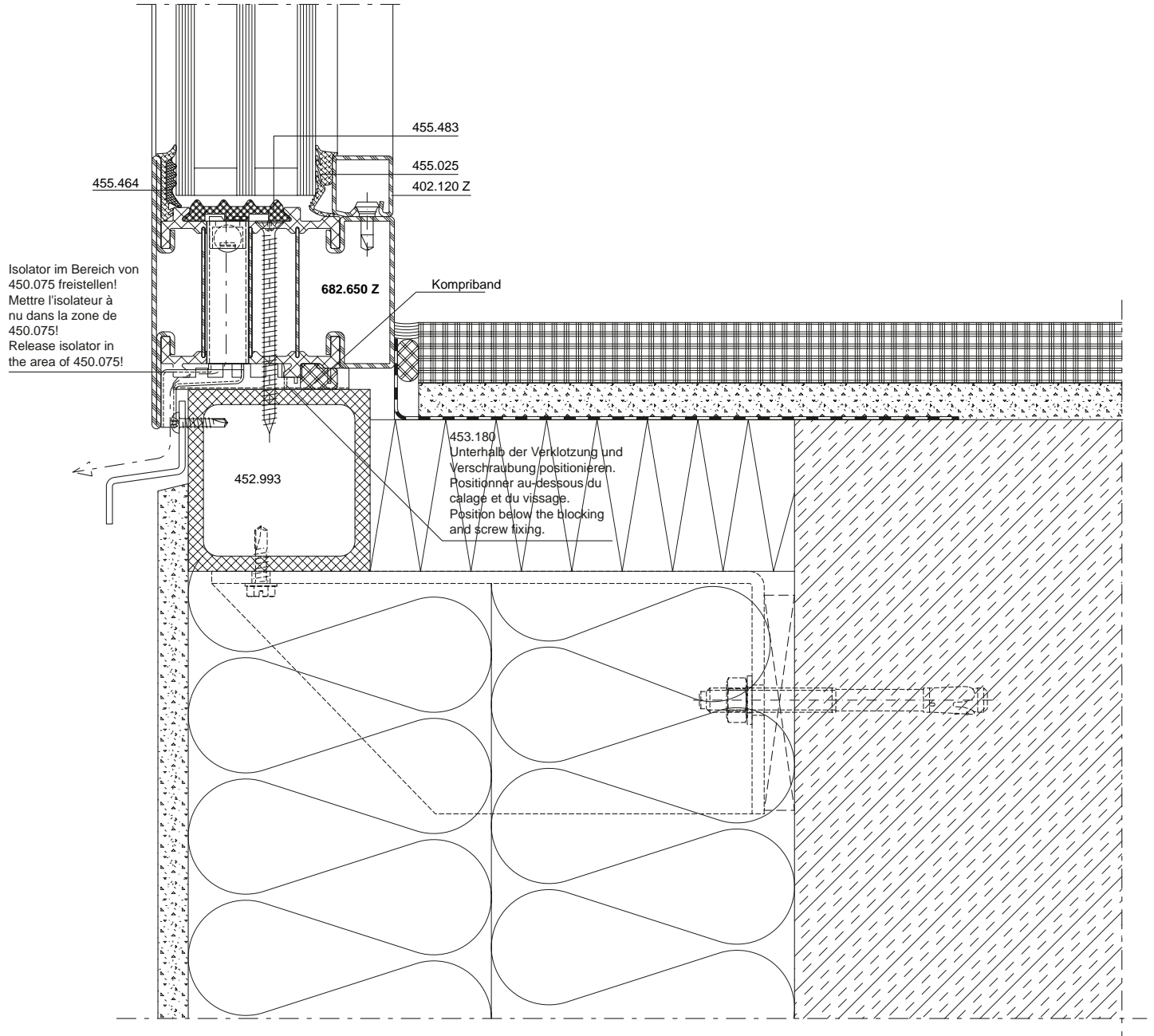

DXF

DWG

12-0201-A-008

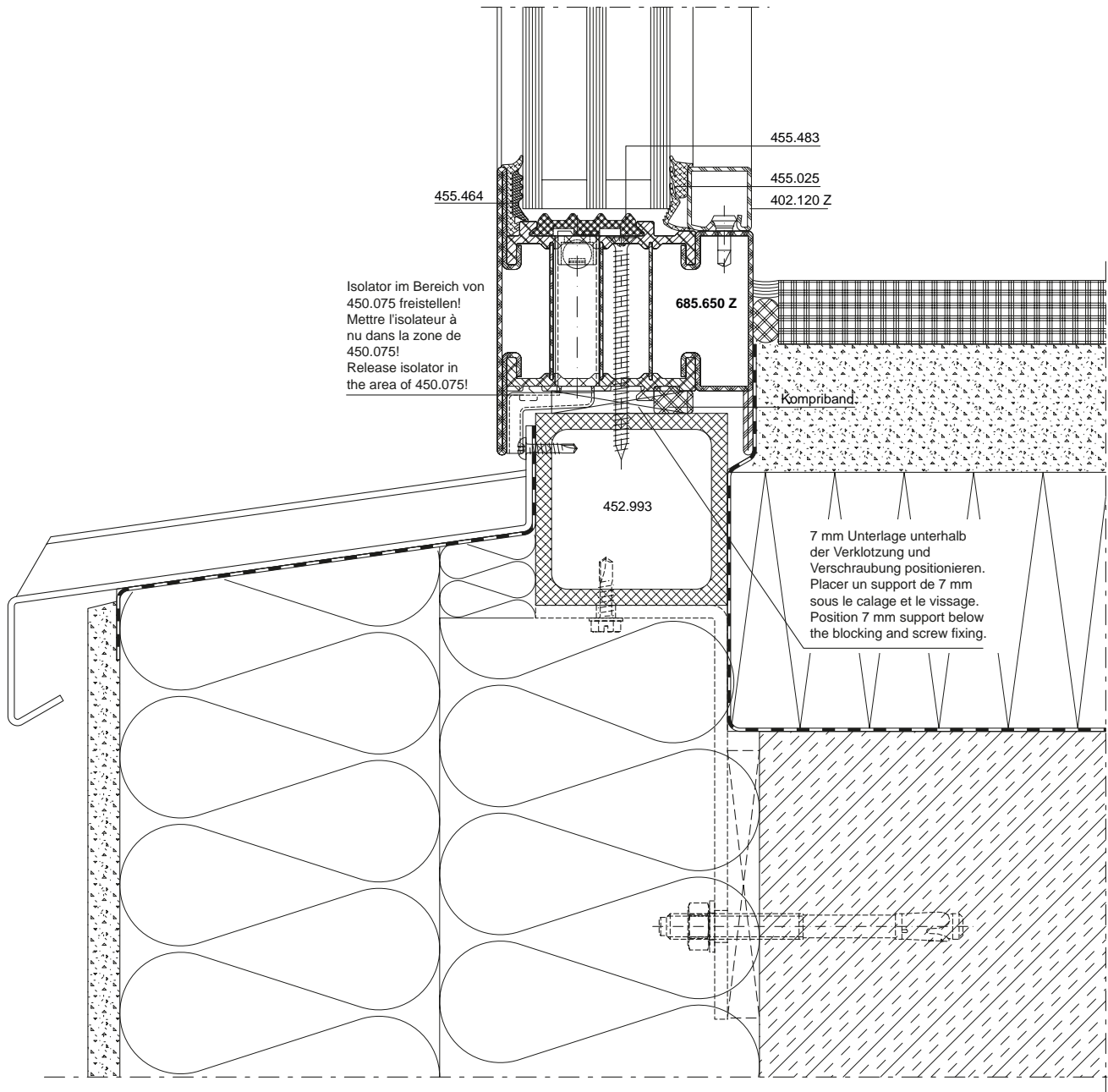

DXF

DWG

12-0201-A-009

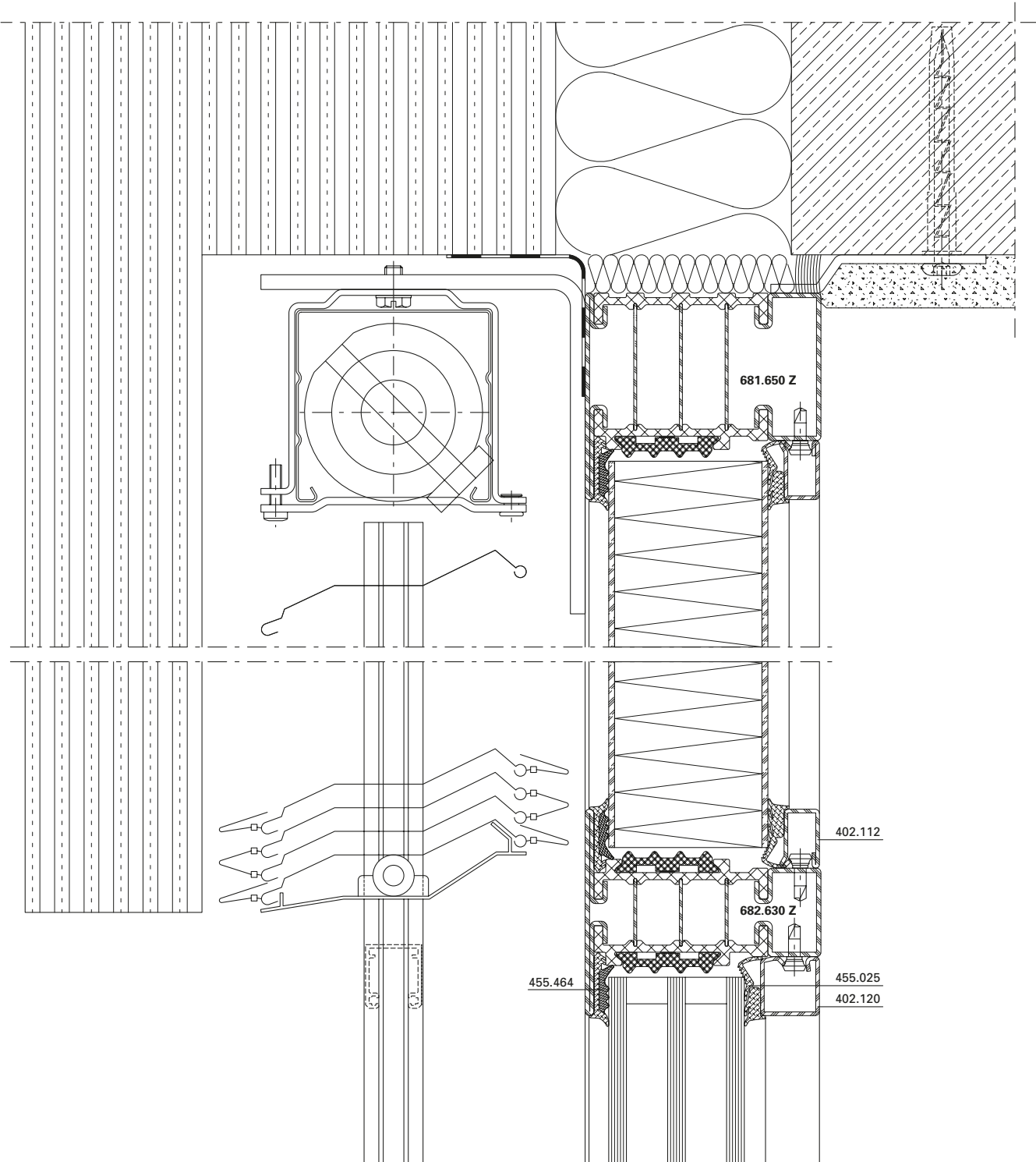

DXF

DWG

12-0201-A-010

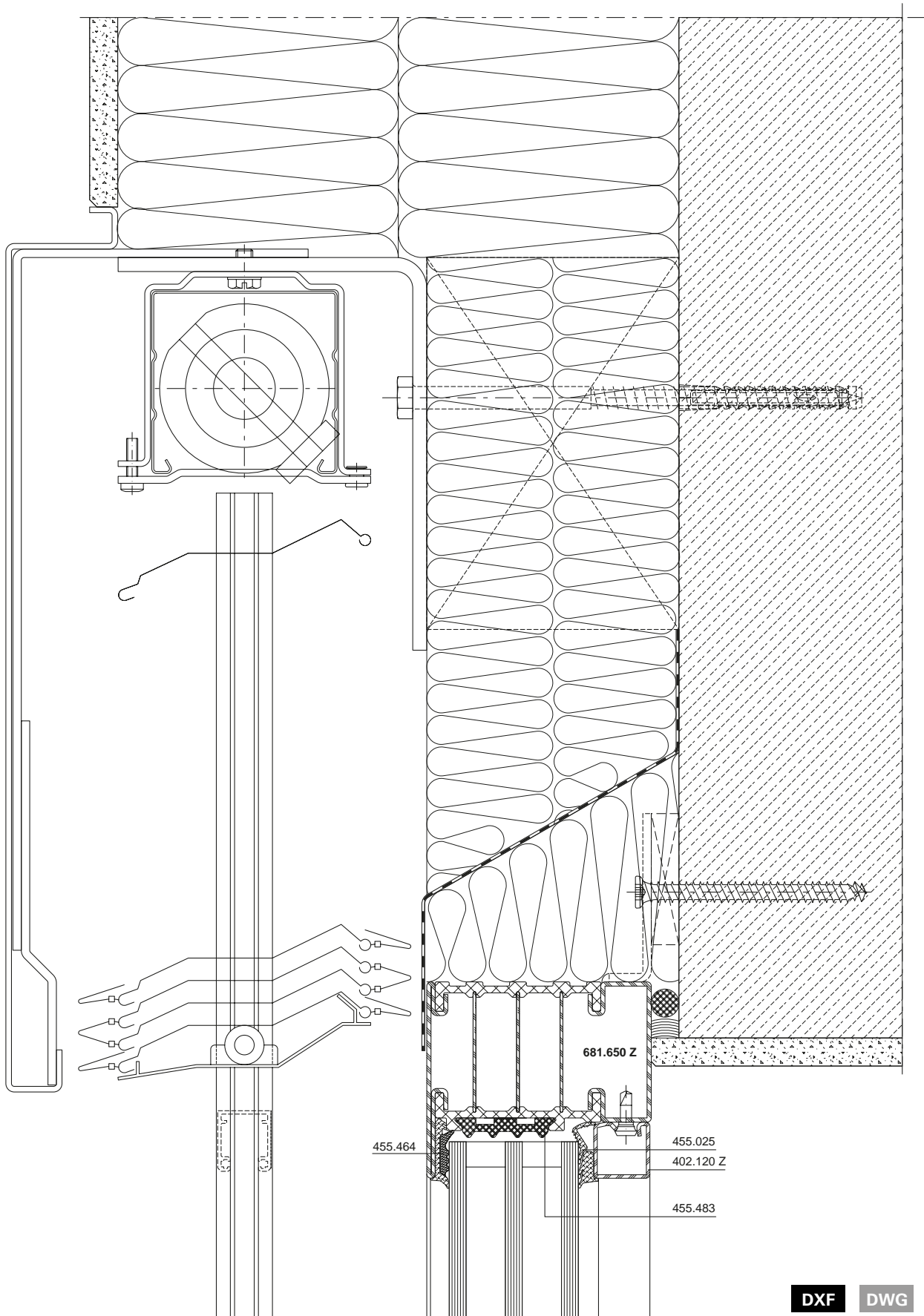

DXF

DWG

12-0201-A-011

Leistungswerte
 Fenster aus Stahl

Caractéristiques de performances
 Fenêtres en acier

Performance values
 Windows made of steel

Schlagregendichtheit
 Luftdurchlässigkeit
 Widerstand bei Windlast

Étanchéité à la pluie battante
 Perméabilité à l'air
 Résistance à la pression du vent

Watertightness
 Air permeability
 Resistance to wind load

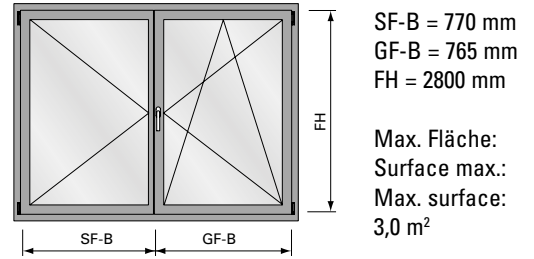
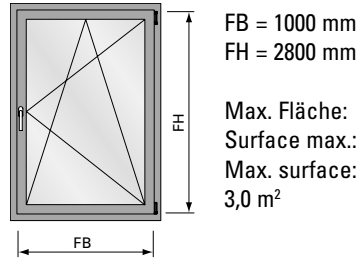

	EN 12208	EN 12207	EN 12210	EN 12208	EN 12207	EN 12210
	Klasse E750 Classe E750 Class E750	Klasse 4 Classe 4 Class 4	Klasse C4/B4 Classe C4/B4 Class C4/B4	Klasse 8A Classe 8A Class 8A	Klasse 4 Classe 4 Class 4	Klasse C4/B4 Classe C4/B4 Class C4/B4
Größenänderungen Variations dimensionnelles Size changes	-100%	-100%	-100%	-100%	-100%	-100%

	EN 12208	EN 12207	EN 12210
	Klasse E750 Classe E750 Class E750	Klasse 4 Classe 4 Class 4	Klasse C4/B4 Classe C4/B4 Class C4/B4
Grösse Festverglasung nach objektspezifischer Glasstatik Taille du vitrage fixe selon la statique du verre spécifique à l'objet Size of fixed glazing according to the glass statics of the specific project			

Leistungswerte für Sondergeometrien

Caractéristiques de performances pour géométrie spéciale

Performances values for special geometry

Schlagregendichtheit
 Luftdurchlässigkeit
 Widerstand bei Windlast

Étanchéité à la pluie battante
 Perméabilité à l'air
 Résistance à la pression du vent

Watertightness
 Air permeability
 Resistance to wind load

Atelierfenster
 Fenêtre trapézoïdale
 Studio window

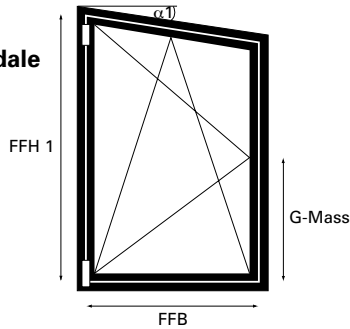

FFB = 1250 mm
 FFH 1 = 2760 mm
 Max. Fläche:
 Surface max.:
 Max. surface:
 2.0 m²

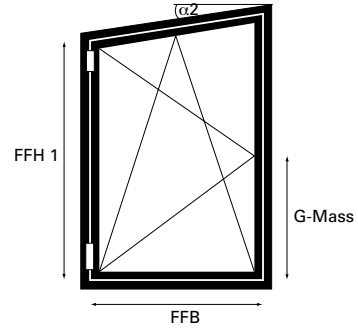

FFB = 1250 mm
 FFH 2 = 2760 mm
 Max. Fläche:
 Surface max.:
 Max. surface:
 2.0 m²

	 EN 12208	 EN 12207	 EN 12210
Anschweissband (Drehfenster) Paumelle à souder (Fenêtre à la française) Weld-on hinge (Side-hung window)	Klasse 9A Classe 9A Class 9A	Klasse 4 Classe 4 Class 4	Klasse C4/B4 Classe C4/B4 Class C4/B4
Fensterbeschlag Ferrure de fenêtre Window fitting	Klasse 9A Classe 9A Class 9A	Klasse 4 Classe 4 Class 4	Klasse C4/B4 Classe C4/B4 Class C4/B4
Größenänderungen Variations dimensionnelles Size changes	-100%	-100%	-100%

Leistungswerte für Sondergeometrien

Caractéristiques de performances pour géométrie spéciale

Performances values for special geometry

Schlagregendichtheit
 Luftdurchlässigkeit
 Widerstand bei Windlast

Etanchéité à la pluie battante
 Perméabilité à l'air
 Résistance à la pression du vent

Watertightness
 Air permeability
 Resistance to wind load

Kippfenster
 Fenêtre à soufflet
 Bottom-hung window

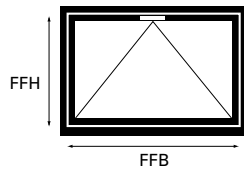

	 EN 12208	 EN 12207	 EN 12210
Anschweisband Schnäpper* Paumelle à souder Loqueteau d'imposte* Weld-on hinge Catch*	Klasse 9A Classe 9A Class 9A	Klasse 4 Classe 4 Class 4	Klasse C3/B3 Classe C3/B3 Class C3/B3
Größenänderungen Variations dimensionnelles Size changes	-100%	-100%	-100%

FFB = 2760 mm
 FFH = 960 mm

Max. Fläche:
 Surface max.:
 Max. surface:
 2.84 m²

* max. Verriegelungsabstand = 1810 mm
 * distance de verrouillage max. = 1810 mm
 * max. distance between locking points = 1810 mm

	 EN 12208	 EN 12207	 EN 12210
Anschweisband Oberlichtöffner F200* Paumelle à souder Ferrure d'imposte F200* Weld-on hinge Top light opener F200*	Klasse 9A Classe 9A Class 9A	Klasse 4 Classe 4 Class 4	Klasse C4/B4 Classe C4/B4 Class C4/B4
Größenänderungen Variations dimensionnelles Size changes	-100%	-100%	-100%

FFB = 2800 mm
 FFH = 960 mm

Max. Fläche:
 Surface max.:
 Max. surface:
 2.84 m²

* max. Verriegelungsabstand = 1440 mm
 * distance de verrouillage max. = 1440 mm
 * max. distance between locking points = 1440 mm

Leistungswerte für Sondergeometrien

Caractéristiques de performances pour géométrie spéciale

Performances values for special geometry





Schlagregendichtheit
 Luftdurchlässigkeit
 Widerstand bei Windlast

Étanchéité à la pluie battante
 Perméabilité à l'air
 Résistance à la pression du vent

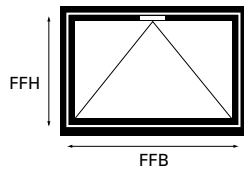
Watertightness
 Air permeability
 Resistance to wind load

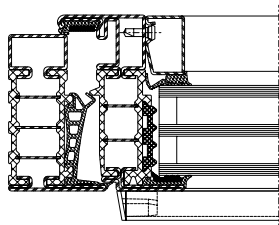
Kippfenster
 Fenêtre à soufflet
 Bottom-hung window



	 EN 12208	 EN 12207	 EN 12210	
	Anschweisband Kettenantrieb EM/2* Paumelle à souder Entraînement à chaîne EM/2* Weld-on hinge Chaîne drive EM/2*	Klasse 9A Classe 9A Class 9A	Klasse 4 Classe 4 Class 4	Klasse C4/B4 Classe C4/B4 Class C4/B4
	Größenänderungen Variations dimensionnelles Size changes	-100%	-100%	-100%

FFB = 2760 mm
 FFH = 960 mm

Max. Fläche:
 Surface max.:
 Max. surface:
 2.84 m²

* max. Verriegelungsabstand = 1810 mm
 * distance de verrouillage max. = 1810 mm
 * max. distance between locking points = 1810 mm

Leistungswerte für Sondergeometrien

Caractéristiques de performances pour géométrie spéciale

Performances values for special geometry

Schlagregendichtheit
 Luftdurchlässigkeit
 Widerstand bei Windlast

Etanchéité à la pluie battante
 Perméabilité à l'air
 Résistance à la pression du vent

Watertightness
 Air permeability
 Resistance to wind load

Kippfenster
 Fenêtre à soufflet
 Bottom-hung window

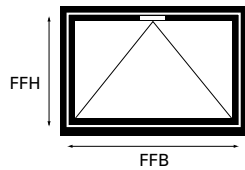

	 EN 12208	 EN 12207	 EN 12210
Kippflügelband Standard Schnäpper* Charnière d'imposte Standard Loqueteau d'imposte* Bottom-hung hinge Standard Catch*	Klasse 8A Classe 8A Class 8A	Klasse 2 Classe 2 Class 2	Klasse C3/B3 Classe C3/B3 Class C3/B3
Größenänderungen Variations dimensionnelles Size changes	-100%	-100%	-100%

FFB = 2760 mm
 FFH = 960 mm

Max. Fläche:
 Surface max.:
 Max. surface:
 2.84 m²

* max. Verriegelungsabstand = 1810 mm
 * distance de verrouillage max. = 1810 mm
 * max. distance between locking points = 1810 mm

	 EN 12208	 EN 12207	 EN 12210
Kippflügelband Standard Oberlichtöffner F200* Charnière d'imposte Standard Ferrure d'imposte F200* Bottom-hung hinge Standard Top light opener F200*	Klasse 6A Classe 6A Class 6A	Klasse 2 Classe 2 Class 2	Klasse C2/B2 Classe C2/B2 Class C2/B2
Größenänderungen Variations dimensionnelles Size changes	-100%	-100%	-100%

FFB = 2760 mm
 FFH = 960 mm

Max. Fläche:
 Surface max.:
 Max. surface:
 2.84 m²

* max. Verriegelungsabstand = 1440 mm
 * distance de verrouillage max. = 1440 mm
 * max. distance between locking points = 1440 mm

Leistungswerte für Sondergeometrien

Caractéristiques de performances pour géométrie spéciale

Performances values for special geometry





Schlagregendichtheit
 Luftdurchlässigkeit
 Widerstand bei Windlast

Étanchéité à la pluie battante
 Perméabilité à l'air
 Résistance à la pression du vent

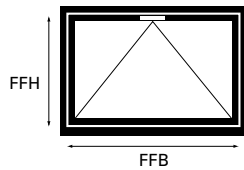
Watertightness
 Air permeability
 Resistance to wind load

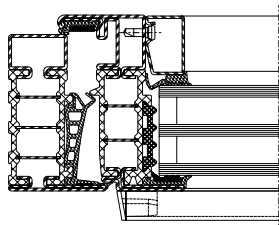
Kippfenster
 Fenêtre à soufflet
 Bottom-hung window



	 EN 12208	 EN 12207	 EN 12210	
	Kippflügelband Standard Kettenantrieb EM/2* Charnière d'imposte Standard Entraînement à chaîne EM/2* Bottom-hung hinge Standard Chaîne drive EM/2*	Klasse 7A Classe 7A Class 7A	Klasse 2 Classe 2 Class 2	Klasse C3/B3 Classe C3/B3 Class C3/B3
	Größenänderungen Variations dimensionnelles Size changes	-100%	-100%	-100%

FFB = 2760 mm
 FFH = 960 mm

Max. Fläche:
 Surface max.:
 Max. surface:
 2.84 m²

- * max. Verriegelungsabstand = 1810 mm
- * distance de verrouillage max. = 1810 mm
- * max. distance between locking points = 1810 mm

U_f-Werte
(nach EN ISO 10077-2:2018-01)

Auf den folgenden Seiten finden Sie die U_f-Werte für die verschiedenen Anwendungen von Janisol HI-Fenster.

Sie basieren auf folgenden Grundlagen:

- Stahl
- Profile bandverzinkter Stahl, unbeschichtet
 - Stahl-Glasleisten
 - Trockenverglasung

Valeurs U_f
(selon EN ISO 10077-2:2018-01)

Vous trouverez les valeurs U_f pour les différentes applications Janisol HI fenêtres dans les pages qui suivent.

Elles se basent sur les principes suivants:

- Acier
- Profilés en bande d'acier zingué, sans revêtement
 - Parcloses en acier
 - Vitrage à sec

U_f values
(according to EN ISO 10077-2:2018-01)

On the following pages you will find the U_f values for the various applications for Janisol HI windows.

They are based on the following:

- Steel
- Strip galvanised steel profiles, uncoated
 - Steel glazing beads
 - Glazing with dry glazing

U_f-Werte
 (nach EN ISO 10077-2:2018-01)

Valeurs U_f
 (selon EN ISO 10077-2:2018-01)

U_f values
 (according to EN ISO 10077-2:2018-01)

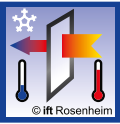
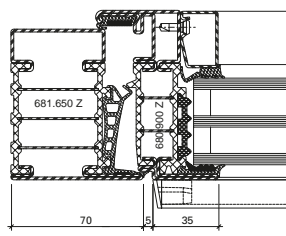
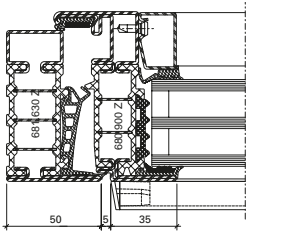
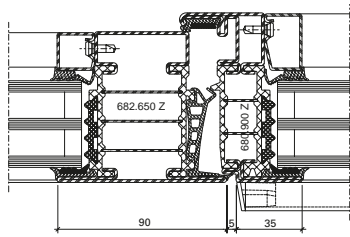
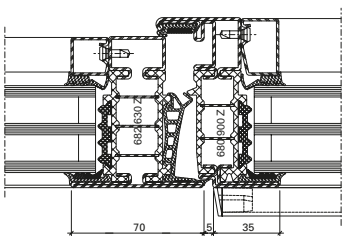
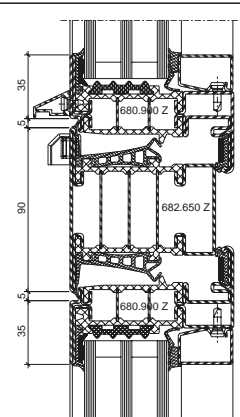
	Füllelementstärken Elements de remplissages Infill elements			
	≥ 46 mm	≥ 36 mm	≥ 36 mm*	≥ 24 mm*
	1,2 W/m²K	1,2 W/m²K	1,3 W/m²K	1,3 W/m²K
	1,3 W/m²K	1,3 W/m²K	1,4 W/m²K	1,5 W/m²K
	1,1 W/m²K	1,2 W/m²K	1,3 W/m²K	1,4 W/m²K
	1,2 W/m²K	1,3 W/m²K	1,4 W/m²K	1,5 W/m²K
	1,2 W/m²K	1,3 W/m²K	1,4 W/m²K	1,4 W/m²K

* ohne Dämmprofil
 * sans profilé isolant
 * without insulating profile

U_f-Werte
 (nach EN ISO 10077-2:2018-01)

Valeurs U_f
 (selon EN ISO 10077-2:2018-01)

U_f values
 (according to EN ISO 10077-2:2018-01)

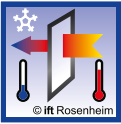
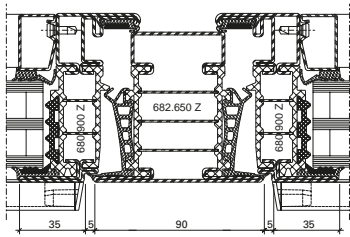
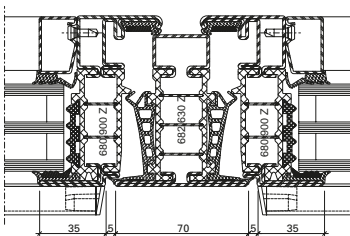
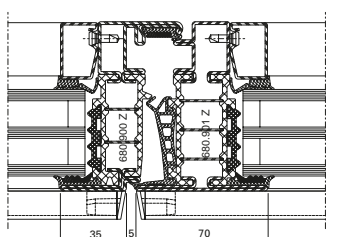
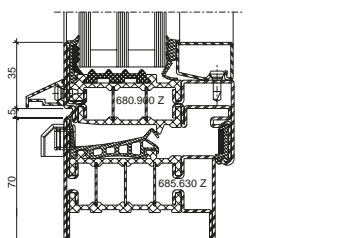
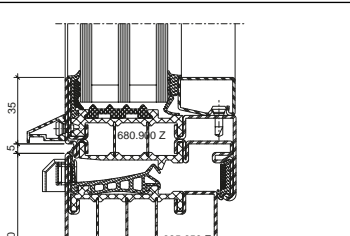
	Füllelementstärken Elements de remplissages Infill elements			
	≙ 46 mm	≙ 36 mm	≙ 36 mm*	≙ 24 mm*
	1,2 W/m²K	1,3 W/m²K	1,4 W/m²K	1,4 W/m²K
	1,3 W/m²K	1,4 W/m²K	1,5 W/m²K	1,5 W/m²K
	1,2 W/m²K	1,3 W/m²K	1,5 W/m²K	1,6 W/m²K
	1,2 W/m²K	1,2 W/m²K	1,3 W/m²K	1,4 W/m²K
	1,1 W/m²K	1,1 W/m²K	1,2 W/m²K	1,2 W/m²K

* ohne Dämmprofil
 * sans profilé isolant
 * without insulating profile

U_f-Werte
 (nach EN ISO 10077-2:2018-01)

Valeurs U_f
 (selon EN ISO 10077-2:2018-01)

U_f values
 (according to EN ISO 10077-2:2018-01)

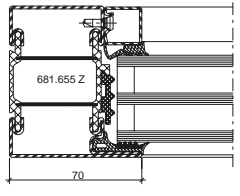
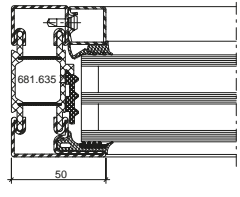
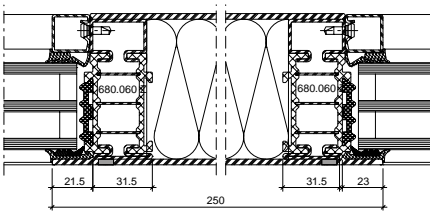
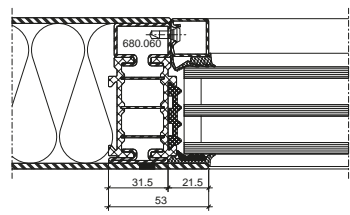
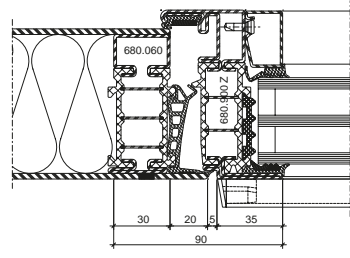
	Füllelementstärken Elements de remplissages Infill elements			
	≥ 46 mm	≥ 36 mm	≥ 36 mm*	≥ 24 mm*
	1,2 W/m²K	1,3 W/m²K	1,4 W/m²K	1,6 W/m²K
	1,4 W/m²K	1,5 W/m²K	1,7 W/m²K	1,9 W/m²K
	0,74 W/m²K	0,77 W/m²K	0,85 W/m²K	0,91 W/m²K
	1,2 W/m²K	1,3 W/m²K	1,4 W/m²K	1,5 W/m²K
	1,3 W/m²K	1,4 W/m²K	1,5 W/m²K	1,6 W/m²K

* ohne Dämmprofil
 * sans profilé isolant
 * without insulating profile

U_f-Werte
 (nach EN ISO 10077-2:2018-01)

Valeurs U_f
 (selon EN ISO 10077-2:2018-01)

U_f values
 (according to EN ISO 10077-2:2018-01)

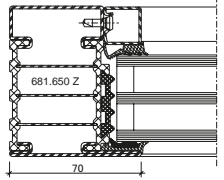
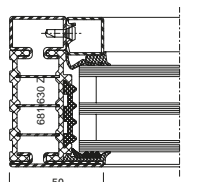
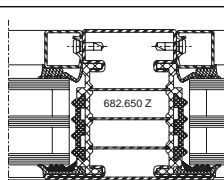
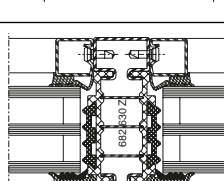
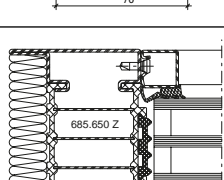
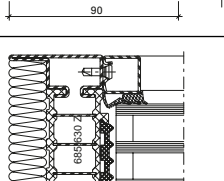
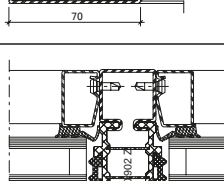
	Füllelementstärken Elements de remplissages Infill elements			
	≥ 46 mm	≥ 36 mm	≥ 36 mm*	≥ 24 mm*
	0,89 W/m²K	0,95 W/m²K	1,1 W/m²K	1,2 W/m²K
	1,0 W/m²K	1,1 W/m²K	1,3 W/m²K	1,4 W/m²K
	0,84 W/m²K	0,93 W/m²K	1,1 W/m²K	1,3 W/m²K
	0,93 W/m²K	1,0 W/m²K	1,3 W/m²K	1,5 W/m²K
	0,80 W/m²K	0,85 W/m²K	0,95 W/m²K	1,0 W/m²K
	0,88 W/m²K	0,95 W/m²K	1,1 W/m²K	1,2 W/m²K
	0,93 W/m²K	1,1 W/m²K	1,3 W/m²K	1,4 W/m²K

- * ohne Dämmprofil
- * sans profilé isolant
- * without insulating profile



Schalldämmung

Ausführungsvarianten

Die nachfolgende Typenübersicht ergibt einen Überblick über die beurteilten Varianten.

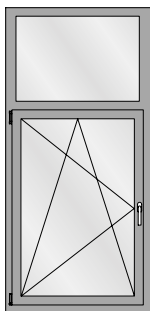
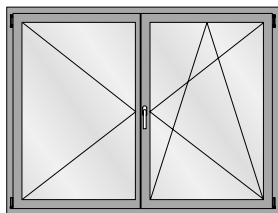
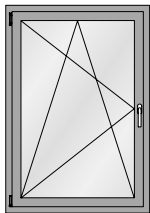

Isolation phonique

Modèles

L'aperçu des types suivant fournit une vue d'ensemble des variantes examinées.

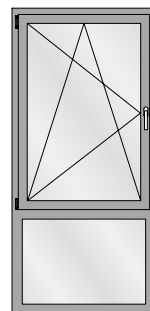
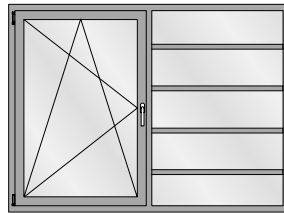
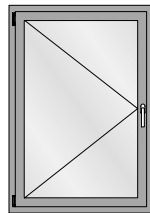

Sound insulation

Design range

The following overview of types provides an overview of the evaluated designs.



Tabelle A1
 Korrekturtabelle für Janisol HI-Fenster
 mit Mehrscheiben-Isolierglas

Tableau A1
 Tableau de correction pour les
 fenêtres Janisol HI avec vitrage isolant
 multi-vitres

Table A1
 Correction table for Janisol HI
 windows with multi-pane insulating
 glass

	1	2	7	8	9	10	11	12	13	14	15
	$R_{W(C, Ctr)}$ dB	Isolierglaseinheit Unité d'isolation Insulating glass unit $R_{W, P, Glas}$ dB	Korrekturen Corrections Corrections								
			K_{RA} dB	K_S dB	K_{FV} dB	K_{Nass} dB	$K_{G 0,4}$ dB	$K_{G 1,0}$ dB	$K_{G 1,8}$ dB	$K_{G 2,6}$ dB	$K_{G 3,2}$ dB
1	33 (-2; -6)	31	-2	0	-1	0	0	0	-1	-2	-3
2	34 (-2; -6)	32	-2	0	-1	0	0	0	-1	-2	-3
3	35 (-2; -6)	34	-2	0	-1	0	0	0	-1	-2	-3
4	36 (-2; -6)	35	-2	0	-1	-1	0	0	-1	-2	-3
5	37 (-2; -6)	37	-2	0	0	-1	0	0	-1	-2	-3
6	38 (-2; -6)	39	-2	0	0	-1	0	0	-1	-2	-3
7	39 (-2; -6)	40	-2	0	0	-1	0	0	-1	-2	-3
8	40 (-2; -4)	41	-2	0	0	-1	-1	0	-1	-2	-3
9	41 (-2; -4)	42	0	0	0	-1	-2	0	-1	-2	-3
10	42 (-2; -4)	43	0	-1	0	-1	-2	0	-1	-2	-3
11	43 (-2; -4)	44	0	-2	0	-1	-2	0	-1	-2	-3
12	44 (-2; -5)	45	0	-2	0	-1	-3	0	-1	-2	-3
13	45 (-2; -5)	49	0	-2	+1	-1	-3	0	-1	-2	-3
14	46 (-2; -6)	50	-1	-3	0	-1	-4	-1	-1	-2	-3

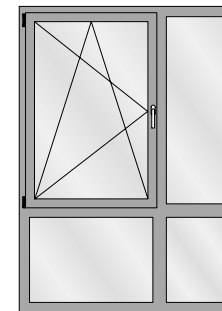
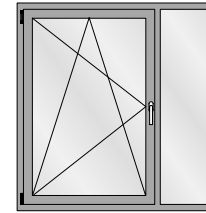
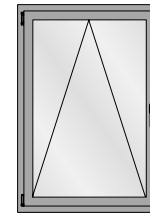
Der aus der Tabelle A1 abzulesende Wert für die Schalldämmung $R_{W, Fenster}$ beträgt:

La valeur à relever sur le tableau A1 concernant l'isolement contre les sons aériens $R_{W, Fenêtre}$ est la suivante:

The value taken from table A1 for the sound insulation $R_{W, Window}$ is:

$$R_{W, Fenster} = R_W + K_{RA} + K_S + K_{FV} + K_{Nass} + K_{G 0,4} + K_{G 1,8} + K_{G 2,6} + K_{G 3,2} \text{ dB}$$

K_{RA} Korrekturwert für einen Rahmenanteil < 30%. Der Rahmenanteil ist die Gesamtfläche des Fensters abzüglich der sichtbaren Scheibengröße. K_{RA} darf bei Festverglasungen nicht berücksichtigt werden.

K_S Korrekturwert für Stulpfenster

K_{FV} Korrekturwert für Festverglasungen mit erhöhtem Scheibenanteil

K_{Nass} Korrekturwert für Nassverglasung

$K_{G 0,4}$ Korrekturwert für Einzelscheiben mit einer Glasfläche $\leq 0,4 \text{ m}^2$. Die Korrektur gilt auch für Konstruktionen mit glasteilenden Sprossen.

$K_{G 1,0}$ Korrekturwert für Einzelscheiben mit einer Glasfläche $\geq 1,0 \text{ m}^2$

$K_{G 1,8}$ Korrekturwert für Einzelscheiben mit einer Glasfläche $\geq 1,8 \text{ m}^2$

$K_{G 2,6}$ Korrekturwert für Einzelscheiben mit einer Glasfläche $\geq 2,6 \text{ m}^2$

$K_{G 3,2}$ Korrekturwert für Einzelscheiben mit einer Glasfläche $\geq 3,2 \text{ m}^2$

R_W bewertetes Schalldämm-Mass des Fensters in Abhängigkeit von der Schalldämmung $R_{W,P, Glas}$

$R_{W,P, Glas}$ bewertetes Schalldämm-Mass (Prüfwert) der Isolierverglasung. Die Werte müssen über eine Prüfung nach ISO 140-3 an einem Prüfmuster im Format 1230 x 1480 mm ermittelt und durch einen Prüfbericht einer anerkannten Prüfstelle nachgewiesen werden. Alternativ können generische Daten nach DIN EN 12758 verwendet werden.

K_{RA} Valeur de correction pour un pourcentage de cadre < 30%. Le pourcentage du cadre est la surface totale de la fenêtre déduite de la dimension de vitre visible. K_{RA} ne doit pas être pris en compte sur les vitrages fixes.

K_S Valeur de correction pour fenêtres à deux vantaux

K_{FV} Valeur de correction pour vitrages fixes à fort pourcentage de vitre

K_{Nass} Valeur de correction pour vitrage avec mastic

$K_{G 0,4}$ Valeur de correction pour vitres individuelles avec une surface vitrée $\leq 0,4 \text{ m}^2$. La correction s'applique aussi aux constructions à meneaux séparant les vitres.

$K_{G 1,0}$ Valeur de correction pour vitres individuelles avec surface vitrée $\geq 1,0 \text{ m}^2$

$K_{G 1,8}$ Valeur de correction pour vitres individuelles avec surface vitrée $\geq 1,8 \text{ m}^2$

$K_{G 2,6}$ Valeur de correction pour vitres individuelles avec surface vitrée $\geq 2,6 \text{ m}^2$

$K_{G 3,2}$ Valeur de correction pour vitres individuelles avec surface vitrée $\geq 3,2 \text{ m}^2$

R_W Mesure d'isolement contre les sons aériens des fenêtres évaluée suivant l'isolement phonique $R_{W,P, vitrage}$

$R_{W,P, vitrage}$ Mesure d'isolement contre les sons aériens (valeur d'essai) du vitrage isolant évaluée. Les valeurs doivent être déterminées par un essai suivant ISO 140-3 sur un spécimen de format 1230x1480 mm et attestées par le procès-verbal d'un bureau de vérification homologué. Alternativement, il est possible d'utiliser des données génériques suivant DIN EN 12758.

K_{RA} Correction value for a frame proportion < 30%. The frame proportion is the total surface area of the window less the visible pane area. K_{RA} must not be taken into account for fixed glazing.

K_S Correction value for double-vent windows

K_{FV} Correction value for fixed glazing with increased proportion of pane

K_{Nass} Correction value for glazing with sealing

$K_{G 0,4}$ Correction value for single panes with a glass area $\leq 0,4 \text{ m}^2$. The correction also applies to buildings with glazing bars

$K_{G 1,0}$ Correction value for single panes with a glass area $\geq 1,0 \text{ m}^2$

$K_{G 1,8}$ Correction value for single panes with a glass area $\geq 1,8 \text{ m}^2$

$K_{G 2,6}$ Correction value for single panes with a glass area $\geq 2,6 \text{ m}^2$

$K_{G 3,2}$ Correction value for single panes with a glass area $\geq 3,2 \text{ m}^2$

R_W Airborne sound reduction index of windows depending on the sound insulation $R_{W,P, glazing}$

$R_{W,P, glazing}$ Airborne sound reduction index (test value) of insulating glazing. The values must be calculated using a test conducted in accordance with ISO 140-3 for a specimen with the dimensions 1230 x 1480 mm and confirmed by a test report of a recognised test centre. Alternatively, generic data can be used in accordance with DIN EN 12758.

Grafische Planungsdaten wie z.B. Anwendungsbeispiele, Konstruktionsdetails, Anschlüsse am Bau, die in unseren physischen oder elektronischen Dokumentationsunterlagen enthalten sind, sind schematische Darstellungen. Gleiches gilt für digitale Medien wie CAD Dateien oder BIM Modelle.

Sie sollen den ausführenden Metallbauer und/oder Fachplaner bei der Planung und Ausführung eines Projektes unterstützen. Sie sind im konkreten Anwendungsfall durch den ausführenden Metallbauer und/oder Fachplaner auf die Verwendbarkeit im konkreten betroffenen Projekt hinsichtlich rechtlichen/regulatorischen aber auch technischen objektspezifischen Anforderungen zu überprüfen und ggfs. eigenverantwortlich anzupassen.

Bei der Überprüfung, der spezifischen Planung und der Umsetzung sind die objektspezifischen Rahmenbedingungen (Material der Bausubstanz, Dimension des Einbauelements, Farbe, Exposition, Lasteinwirkung, etc.) sowie der geltende Stand der Technik einschliesslich aller anwendbaren Normen und technischen Richtlinien eigenverantwortlich zu beachten.

Falls das vorliegende Dokument Differenzen zur aktuellen deutschen Version (Artikel Nr. K1214220) aufweist, gilt in jedem Fall der deutsche Originaltext in der jeweils geltenden Fassung im Jansen Docu Center.

Alle Ausführungen dieser Dokumentation haben wir sorgfältig und nach bestem Wissen zusammengestellt. Wir können aber keine Verantwortung für die Benutzung der vermittelten Vorschläge und Daten übernehmen. Wir behalten uns technische Änderungen ohne Vorankündigung vor.

Les données de planification graphiques, comme les exemples d'application, détails de construction et raccordements au bâtiment, fournies dans notre documentation physique et numérique sont des représentations schématiques. Il en va de même pour les médias numériques comme les fichiers CAD ou modèles BIM.

Leur but est de faciliter la planification et réalisation d'un projet par les constructeurs métalliques et/ou concepteurs. Concrètement, elles doivent être vérifiées par le constructeur métallique et/ou le concepteur et, le cas échéant, modifiées de son propre chef pour s'assurer qu'elles concordent avec le projet concerné et qu'elles répondent aux exigences techniques spécifiques ainsi qu'aux dispositions légales et réglementaires.

Lors de la vérification, de la planification spécifique et de la mise en œuvre, il y a lieu de tenir compte des conditions spécifiques à l'objet (matériaux du bâtiment, dimension de l'élément d'insert, couleur, exposition, effet de charge, etc.) ainsi que de l'état actuel de la technique, y compris toutes les normes et directives techniques applicables.

En cas de divergence entre le présent document et la version allemande (no d'article K1214220), c'est dans tous les cas le texte original allemand qui prévaut dans sa version actuelle disponible dans le Jansen Docu Center.

Nous avons apporté le plus grand soin à l'élaboration de cette documentation. Cependant, nous déclinons toute responsabilité pour l'utilisation faite de nos propositions et de nos données.

Nous nous réservons le droit de procéder à des modifications techniques sans préavis.

Graphical planning data such as application examples, construction details, connections on site that are contained in our physical or electronic documentation components are schematic representations. The same applies to digital media such as CAD files or BIM models.

They are intended to support the metal worker and/or design engineer in planning and executing projects. In the specific case of application they are to be checked by the metal worker and/or design engineer in terms of their usability in the specific project concerned with regard to legal/regulatory and technical property-specific requirements and adjusted if necessary at the latter's own responsibility.

The property-specific underlying conditions (construction material, dimensions of installation element, colour, exposure, load effect etc.) and current state of the art including all applicable norms and technical guidelines are to be taken into consideration at the metal worker and/or design engineer's own responsibility during the review, specific planning and implementation.

If there are any differences between this document and the current German version (item number K1214220), the latest version of the original German text in the Jansen Docu Center shall prevail.

All the information contained in this documentation is given to the best of our knowledge and ability. However, we decline all responsibility for the use made of these suggestions and data.

We reserve the right to effect technical modifications without prior warning.

Inhaltsverzeichnis
Sommaire
Content

Janisol HI Fenster
Janisol HI fenêtres
Janisol HI windows

Systemübersicht

Merkmale
Leistungseigenschaften
Systemausführungen
Typenübersicht

Sommaire du système

Caractéristiques
Caractéristiques de performance
Exécutions de système
Sommaire des types

Summary of system

Characteristics
Performance characteristics
System versions
Summary of types

2

Profilsortiment

Assortiment de profilé

Range of profiles

9

Beispiele

Schnittpunkte
Konstruktionsdetails
Anschlüsse am Bau

Exemples

Coupes de détails
Détails de construction
Raccords au mur

Examples

Section details
Construction details
Attachment to structure

12

Leistungseigenschaften

Caractéristiques de performance

Performance characteristics

38

Merkmale
Caractéristiques
Characteristics

Janisol HI Fenster
Janisol HI fenêtres
Janisol HI windows

- Hervorragende wärmetechnische Eigenschaften für maximale Anforderungen
- Bautiefe Flügel 90 mm, Festverglasung 80 mm
- Schmale Profilansichten: Rahmen 50 resp. 70 mm, Pfosten/Riegel 70 resp. 90 mm, Flügel 35 mm, Stulpflügelpartie 110 mm
- Isolierstege mit besten bauphysikalischen Eigenschaften aus glasfaserverstärktem Kunststoff
- Mit Euro-Beschlagsnute für Dreh-, Drehkipp-, Stulp- und Kippflügel-Fenster
- Fensterflügel Größen bis max. 2800 mm Höhe
- Fensterflügel-Gewichte: verdeckt liegend bis 180 kg, aufgesetzt bis 150 kg
- Glasdicke für Fensterflügel 24-67 mm, für Festverglasung 24-57 mm
- Systemprüfung nach Produktnorm EN 14351-1 für alle Fenster-Öffnungsarten
- Sehr gute statische Werte, hohe mechanische Festigkeiten
- Dauerfunktionsprüfung nach EN 12400 Drehfenster Klasse 4 Drehkippfenster Klasse 3
- Für Nasslack- oder Pulverbeschichtung geeignet
- Excellentes propriétés thermiques répondant à des exigences maximum
- Profondeur de montage vantail 90 mm, vitrage fixe 80 mm
- Profilés très fins: Cadre 50 et 70 mm, montant/traverse 70 ou 90 mm, vantail 35 mm, partie à deux vantaux à la française 110 mm
- Traverses isolantes aux excellentes propriétés physiques en matière plastique renforcé par fibres de verre
- Avec rainure de ferrure Euro pour fenêtres à la française, oscillo-battantes, à deux vantaux et à soufflet
- Tailles d'ouvrant de fenêtre jusqu'à max. 2800 mm de hauteur
- Poids des ouvrants de fenêtre: non apparents jusqu'à 180 kg, plaqués jusqu'à 150 kg
- Épaisseur de vitrage pour ouvrants de fenêtre 24-67 mm, pour vitrage fixe 24-57 mm
- Contrôle du système selon la norme produit EN 14351-1 pour tous les types d'ouverture de fenêtre
- Très bonnes valeurs statiques, résistances mécaniques élevées
- Durabilité mécanique selon EN 12400 Fenêtres à la française classe 4 Fenêtres oscillo-battantes classe 3
- Convient au revêtement à la peinture liquide ou poudre
- Outstanding thermal properties for the most exacting requirements
- Basic depth of vent 90 mm, fixed glazing 80 mm
- Narrow profile face widths: frame 50 or 70 mm, mullion/transom 70 or 90 mm, vent 35 mm, double-vent meeting stile assembly 110 mm
- Insulating bars with optimum structural properties made from glass fibre-reinforced plastic
- With Euro fittings groove for side-hung, turn/tilt, double-vent and bottom-hung windows
- Window vent dimensions up to max. 2800 mm in height
- Window vent weights: concealed up to 180 kg, surface-mounted up to 150 kg
- Glass thickness for window vent 24-67 mm, for fixed glazing 24-57 mm
- System testing in accordance with product standard EN 14351-1 for all window opening types
- Excellent structural values, high levels of mechanical strength
- Mechanical durability in accordance with EN 12400 Side-hung windows class 4 Turn/tilt windows class 3
- Suitable for wet paint or powder coating

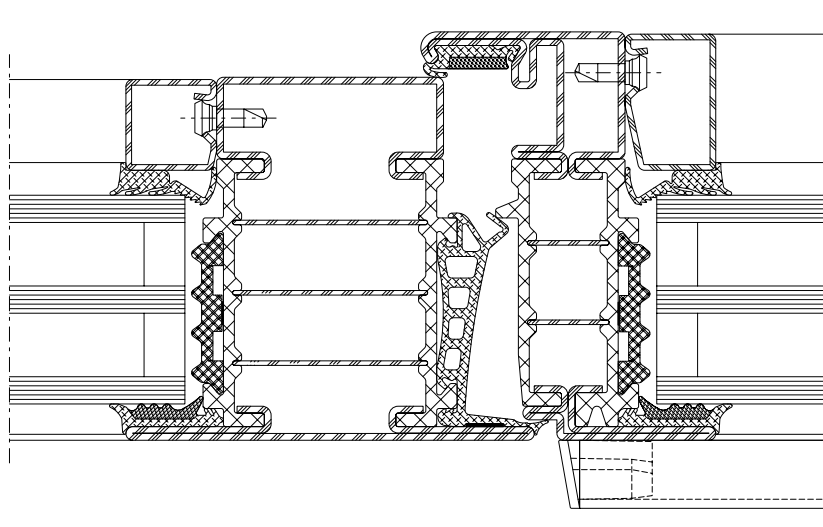

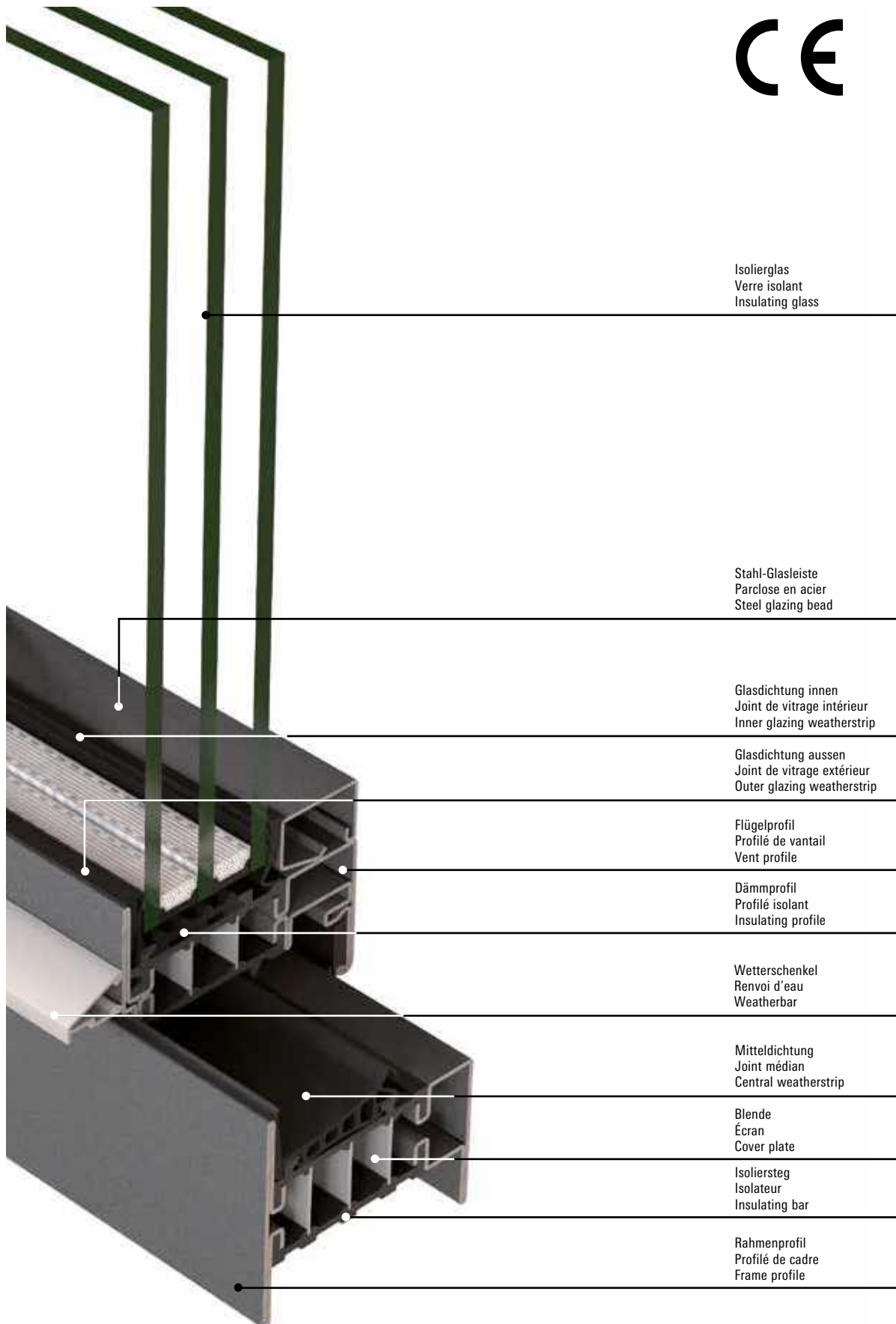

Isolierglas
Verre isolant
Insulating glass

Stahl-Glasleiste
Parclose en acier
Steel glazing bead

Glasdichtung innen
Joint de vitrage intérieur
Inner glazing weatherstrip

Glasdichtung aussen
Joint de vitrage extérieur
Outer glazing weatherstrip

Flügelprofil
Profilé de vantail
Vent profile

Dämmprofil
Profilé isolant
Insulating profile













Wetterschenkel
Renvoi d'eau
Weatherbar

Mitteldichtung
Joint médian
Central weatherstrip

Blende
Écran
Cover plate

Isoliersteg
Isolateur
Insulating bar

Rahmenprofil
Profilé de cadre
Frame profile

Norm	Eigenschaft Caractéristique Characteristic	Klassifizierung/Wert Classification / Valeur Classification / Value														
		npd	C1 (400)	C2 (800)	C3 (1200)	C4 (1600)	C5 (2000)	1A (0)	2A (50)	3A (100)	4A (150)	5A (200)	6A (250)	7A (300)	8A (450)	9A (600)
 EN 12210	Widerstandsfähigkeit bei Windlast Résistance à la pression du vent Resistance to wind load	npd	C1 (400)	C2 (800)	C3 (1200)	C4 (1600)	C5 (2000)									
 EN 12208	Schlagregendichtheit Etanchéité à la pluie battante Watertightness	npd	1A (0)	2A (50)	3A (100)	4A (150)	5A (200)	6A (250)	7A (300)	8A (450)	9A (600)	Exxx (>750)				
 EN ISO 10140	Schalldämmung R_w (C, C_{tr}) (dB) Isolation phonique R_w (C, C_{tr}) (dB) Sound insulation R_w (C, C_{tr}) (dB)	npd	bis R_w 46 dB (-2; -6) jusqu'à R_w 46 dB (-2; -6) up to R_w 46 dB (-2; -6)													
 EN ISO 10077-2	Wärmedurchgangskoeffizient U_f (W/(m²·K)) Transmission thermique U_f (W/(m²·K)) Thermal production U_f (W/(m²·K))	npd	ab 0,74 W/m ² ·K à partir de 0,74 W/m ² ·K from 0,74 W/m ² ·K													
 EN 12207	Luftdurchlässigkeit Perméabilité à l'air Air permeability	npd	1 (150)	2 (300)	3 (600)	4 (600)										
 EN 14024	Tragfähigkeit von Sicherheitsvorrichtungen Capacité portante des dispositifs de sécurité Load-bearing capacity of safety devices		Anforderung erfüllt Exigence remplie Requirement satisfied													
 EN 14024	Metallprofile mit thermischer Trennung Profilés en métal. avec rupture de pont thermique Metal profiles with thermal barrier		CW / TC2													
 EN 12400	Dauerfunktionsprüfung Durabilité mécanique Mechanical durability	D	1 5'000	2 10'000	3 20'000	4 50'000	5 100'000	6 200'000	7 500'000	8 1'000'000						
 EN 13115	Bedienkräfte Forces de manœuvre Operating forces	npd	0	1	2											
 EN 1627	Einbruchhemmung Anti-effraction Burglar resistance	npd	1	2	3	4	5	6								
 ISO 16000	Gefährliche Substanzen Substances dangereuses Dangerous substances	npd	Anforderung erfüllt Exigence remplie Requirement satisfied													
 DIN 18008-4	Vorgefertigte absturzsichernde Verglasung Vitrage anti-chutes préfabriqué Prefabricated glazing suitable for safety barrier loading		Anhang D.1.2 erfüllt Annexe D.1.2 remplie Appendix D.1.2 satisfied													

npd = keine Leistung festgestellt
(no performance determined)

npd = Aucune performance déterminée
(no performance determined)

npd = no performance determined



Einbruchhemmende Janisol HI Fenster

- Flügelgrößen bis 1475 x 2800 mm
- Dreh-, Drehkipp-, Stulpfenster und Festverglasungen
- Beschlag als Komplettseinheit geliefert
- Prüfungen nach EN 1627 bis 1630 bis RC3

Fenêtres anti-effraction Janisol HI

- Dimensions de vantail jusqu'à 1475 x 2800 mm
- Fenêtres ouvrant à la française, oscillo-battantes, à deux vantaux et vitrages fixes
- Ferrures livrées comme unité complète
- Contrôlé selon les normes EN 1627 à 1630 jusqu'à RC3

Burglar-resistant Janisol HI windows

- Vent sizes up to 1475 x 2800 mm
- Side-hung, turn/tilt and double-vent windows and fixed glazing
- Fitting supplied as complete unit
- Tests in accordance with EN 1627 to 1630 up to RC3

Jansen Docu Center

Die Plattform zum effizienten Arbeiten mit Jansen Dokumentationen. Im Jansen Docu Center stehen alle Produktinformationen jederzeit digital in der aktuellsten Version zur Verfügung: von Architekten-Informationen über Bestell- und Fertigungskatalogen bis hin zu Anleitungen und Prospekten sowie Videos.

Die Inhalte können einfach und schnell aufgerufen werden. Ein für den Anwender komfortables papierloses Arbeiten, das zahlreiche Vorteile bietet.

Download CAD Daten

DXF

DWG

Sie können die Zeichnungen in den Formaten DXF und/oder DWG herunterladen. Klicken Sie auf das entsprechende Icon und der Download erfolgt.

Die Hinweise «Artikelbibliothek/Türbeschläge/Fensterbeschläge» bedeuten, dass Sie mit einem Klick die gesamte Artikelbibliothek des entsprechenden Systems herunterladen (Profile, Beschläge, Glasleisten, Zubehör etc.).

Info und Beratung

Gerne beraten wir Sie persönlich und stehen Ihnen bei Fragen zur Verfügung. Bitte schreiben Sie uns Ihre Anliegen an: info@jansen.com

Jansen Docu Center

La plate-forme pour travailler efficacement avec les documentations Jansen. Le Jansen Docu Center met à votre disposition les informations sur les produits, en format numérique et dans une version actualisée: des catalogues de commande et de fabrication aux instructions et prospectus, en passant par les informations destinées aux architectes et vidéos.

Les contenus sont facilement et rapidement accessibles. Une manière de travailler confortable et offrant de nombreux avantages.

Télécharger fichiers DAO

DXF

DWG

Vous pouvez télécharger les dessins aux formats DXF et/ou DWG. Cliquez sur l'icône correspondante et le téléchargement s'effectuera.

Les indications «Bibliothèque des articles/Ferures de porte/Ferrures de fenêtres» signifie que vous téléchargez la totalité de la bibliothèque des articles du système donné (profilés, ferrures, parcloles, accessoires etc.).

Info et conseils

Nous vous conseillerons volontiers individuellement et sommes à votre disposition si vous avez des questions à poser. Veuillez nous envoyer votre requête à: info@jansen.com

Jansen Docu Center

The platform for working efficiently with Jansen documentation. The latest version of all the product information is available digitally at any time in the Jansen Docu Center – from order and fabrication manuals to architect information, instructions and brochures and videos.

The content can be retrieved quickly and easily. The user can work conveniently without paper, which has numerous benefits.

Download CAD files

DXF

DWG

You can download the drawings in DXF and/or DWG format. Click on the relevant icon to begin the download.

The items «Article library/Door fittings/Window fittings» means that you download the entire article library for the corresponding system with one click (profiles, fittings, glazing beads, accessories etc.).

Information and advice

We would be delighted to provide you with advice in person and are available to answer any questions you may have. Please write to us with your queries at: info@jansen.com

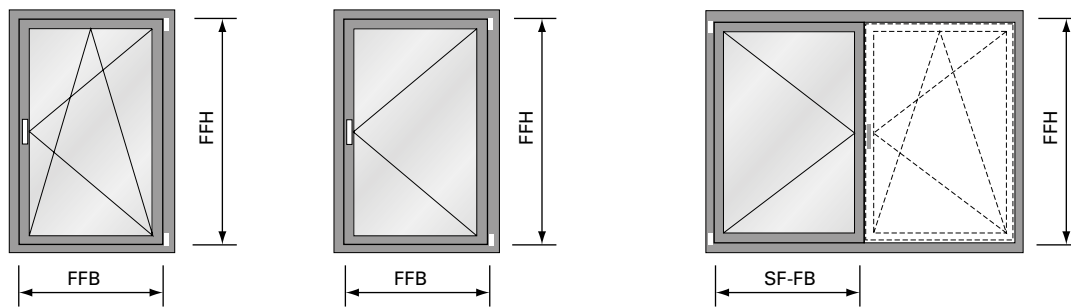

*Flügelgrößen Drehkipp-,
 Drehfenster und Stulpfenster:*

Max.	FFH = 2760 mm
	FFB = 1435 mm
	SF-FB = 1435 mm
Min.	FFH = 600 mm
	FFB = 600 mm
	SF-FB = 370 mm*
	SF-FB = 480 mm**
Max. Fläche:	3.0 m ²
Max. Gewicht:	180 kg
FFB/FFH:	≤ 2

*Grandeurs du vantail fenêtre
 oscillo-battante, à la française et
 fenêtre à deux vantaux:*

Max.	FFH = 2760 mm
	FFB = 1435 mm
	SF-FB = 1435 mm
Min.	FFH = 600 mm
	FFB = 600 mm
	SF-FB = 370 mm*
	SF-FB = 480 mm**
Surface max.:	3.0 m ²
Poids max.:	180 kg
FFB/FFH:	≤ 2

*Size of sash turn/tilt, side-hung and
 double-sash windows:*

Max.	FFH = 2760 mm
	FFB = 1435 mm
	SF-FB = 1435 mm
Min.	FFH = 600 mm
	FFB = 600 mm
	SF-FB = 370 mm*
	SF-FB = 480 mm**
Max. surface:	3.0 m ²
Max. weight:	180 kg
FFB/FFH:	≤ 2

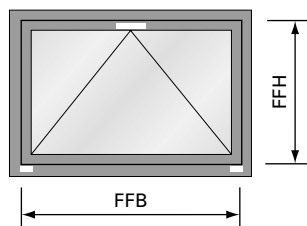

Flügelgröße Kipp-Fenster:

Max.	FFH = 2760 mm
	FFB = 2760 mm
Min.	FFH = 600 mm
	FFB = 600 mm
Max. Fläche:	3.0 m ²
Max. Gewicht:	80 kg
	(2 Bänder)
	120 kg
	(3 Bänder)
FFB/FFH:	≤ 2

*Grandeur du vantail fenêtre à
 soufflet:*

Max.	FFH = 2760 mm
	FFB = 2760 mm
Min.	FFH = 600 mm
	FFB = 600 mm
Surface max.:	3.0 m ²
Poids max.:	80 kg
	(2 paumelles)
	120 kg
	(3 paumelles)
FFB/FFH:	≤ 2

Size of sash bottom-hung window:

Max.	FFH = 2760 mm
	FFB = 2760 mm
Min.	FFH = 600 mm
	FFB = 600 mm
Max. surface:	3.0 m ²
Max. weight:	80 kg
	(2 hinges)
	120 kg
	(3 hinges)
FFB/FFH:	≤ 2

* Standard-Fensterbeschlag
 ** Verdeckt liegender Fensterbeschlag

* Ferrure de fenêtre Standard
 ** Ferrure de fenêtre non apparente

* Standard window fitting
 ** Concealed window fitting

Empfehlung Jansen:
 Flügelhöhe und Flügelbreite 1 mm ins
 Minus schneiden betreffend Sollmass.

Recommandation Jansen:
 Couper la hauteur et la largeur de
 vantail à 1 mm de moins que la cote
 de consigne.

Jansen recommendation:
 Cut sash height and sash width 1 mm
 into the minus relative to the target
 dimension.

Typenübersicht
Sommaire des types
Summary of types

Janisol HI Fenster
Janisol HI fenêtres
Janisol HI windows

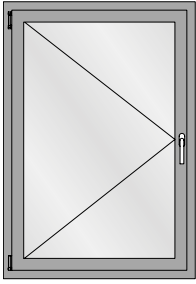

Drehflügel
 Fenêtre à la française
 Side-hung window

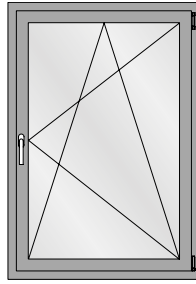

Drehkipp-Flügel
 Vantail oscillo-battant
 Turn/tilt window

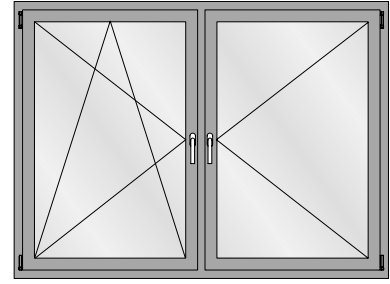

Drehkipp/Drehflügel (mit Pfosten)
 Vantail oscillo-battant/fenêtre à la française
 (avec montant)
 Side-hung/turn/tilt window (with mullion)

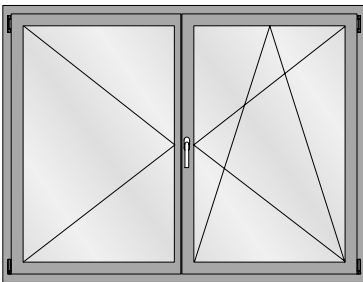

Drehkipp/Drehflügel (Stulpfenster)
 Vantail oscillo-battant/fenêtre à la française
 (Fenêtre à deux vantaux)
 Side-hung/turn/tilt window (Double-vent window)

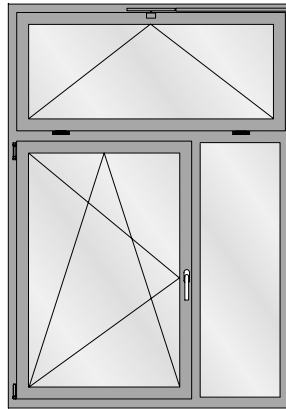

Drehkipp-Flügel mit Festverglasung und Oberlicht
 Vantail oscillo-battant avec vitrage fixe et imposte
 Turn/tilt window with fixed lights and top lights

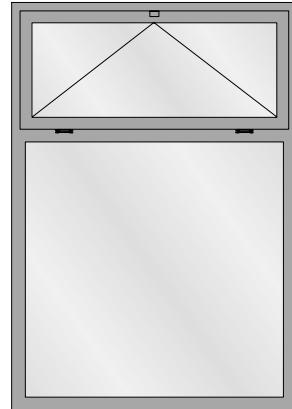

Festverglasung mit Oberlicht
 Vitrage fixe avec imposte
 Fixed lights with top light

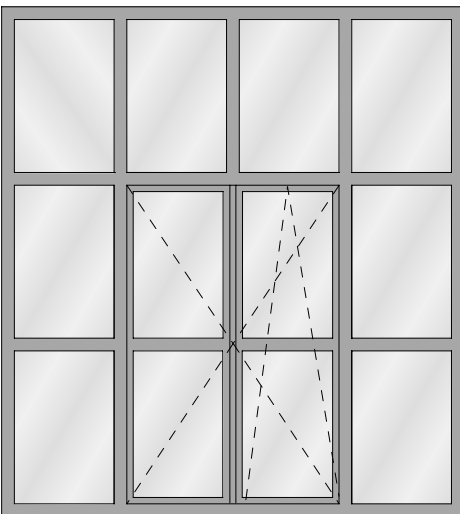

Drehkipp-Flügel mit Festverglasung
 Vantail oscillo-battant avec vitrage fixe et imposte
 Turn/tilt window with fixed lights and top lights



Festverglasung mit Rundbogen
 Vitrage fixe avec demi-rond
 Fixed lights with round arched

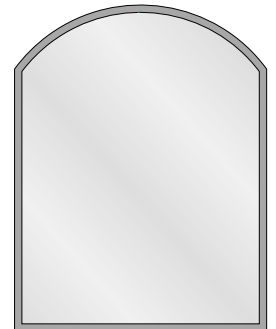
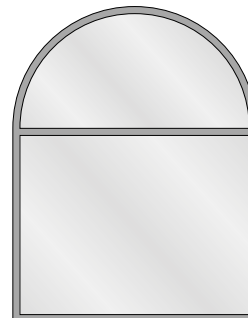

Profilübersicht
Sommaire des profilés
Summary of profiles

Janisol HI Fenster
 Janisol HI fenêtres
 Janisol HI windows

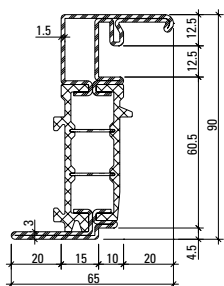

680.900 Z

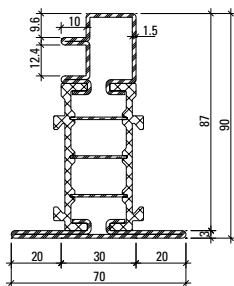

680.901 Z

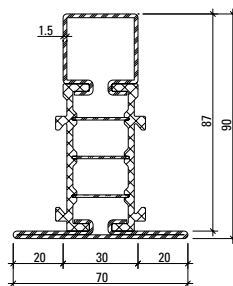

680.902 Z

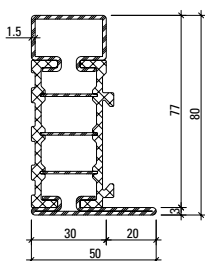

681.630 Z

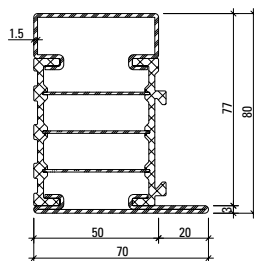

681.650 Z

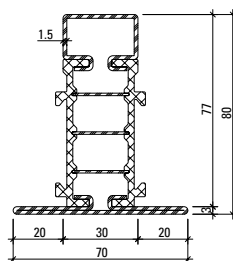

682.630 Z

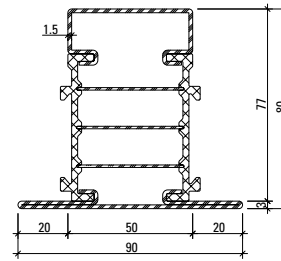

682.650 Z

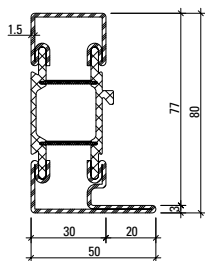

681.635 Z*

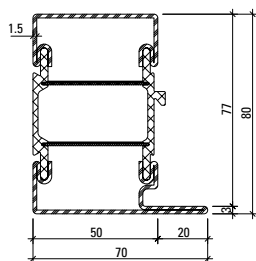

681.655 Z*

*in Kombination mit Bogen
 *en combinaison avec des cintres
 *in combination with arched design

Profil-Nr.	G kg/m	I _x cm ⁴	W _x cm ³	I _y cm ⁴	W _y cm ³	U m ² /m
681.630 Z	3,713	25,83	5,65	5,61	1,85	0,297
681.650 Z	4,331	32,30	7,21	15,97	4,04	0,337
682.630 Z	4,194	31,56	6,24	9,87	2,82	0,352
682.650 Z	4,816	38,99	7,94	24,03	5,34	0,392
680.900 Z	4,735					0,388
680.901 Z	4,618					0,390
680.902 Z	4,426	38,56	6,90	10,73	3,07	0,372
681.635 Z	3,784	26,93	5,71	7,49	2,42	0,310
681.655 Z	4,286	33,47	7,25	21,06	5,28	0,348

Artikelbibliothek
 Bibliothèque des articles
 Article library

DXF **DWG**

Profilübersicht
Sommaire des profilés
Summary of profiles

Janisol HI Fenster
 Janisol HI fenêtres
 Janisol HI windows

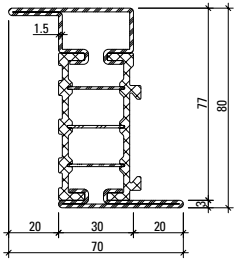

683.630 Z

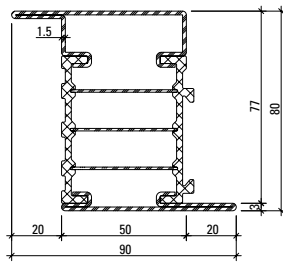

683.650 Z

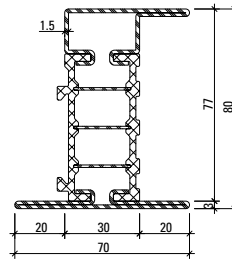

685.630 Z

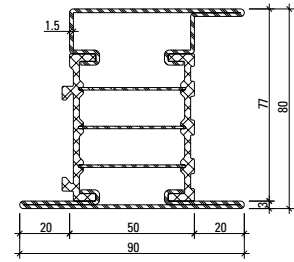

685.650 Z

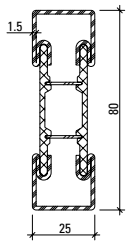

600.012
600.012 Z

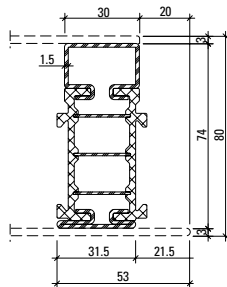

680.060 Z



Werkstoffe

Artikel-Nr.

ohne Zusatz = blank

mit Z = bandverzinkter Stahl

Isolator = glasfaserverstärkter Kunststoff

Matériaux

No. d'article

sans supplément = brut

avec Z = bande d'acier zinguée

Isolateur = matière plastique renforcé par fibres de verre

Materials

Part no.

without addition = bright

with Z = strip galvanised steel

Insulator = glassfibre reinforced plastic

Profil-Nr.	G kg/m	Ix cm ⁴	Wx cm ³	Iy cm ⁴	Wy cm ³	U m ² /m
683.630 Z	4,170	32,73	7,98	10,09	2,88	0,336
683.650 Z	4,787	38,93	9,50	24,43	5,42	0,376
685.630 Z	4,637	38,31	8,65	13,46	3,51	0,374
685.650 Z	5,258	47,62	10,93	30,13	6,14	0,415
600.012	3,254	19,67	4,92	2,93	2,34	0,224
680.060 Z	3,214	17,21	4,55	2,54	1,48	0,266

Bogenfenster
Fenêtres cintrées
Arched windows

Janisol HI Fenster
 Janisol HI fenêtres
 Janisol HI windows

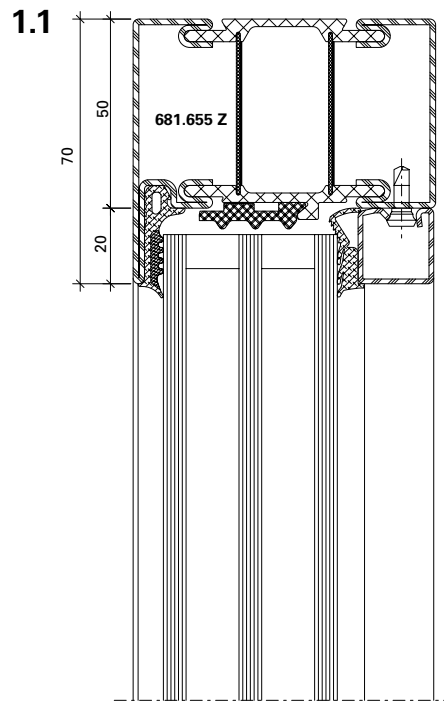
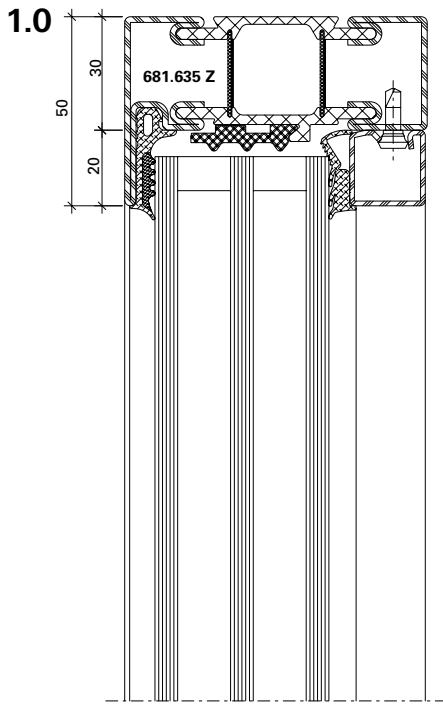
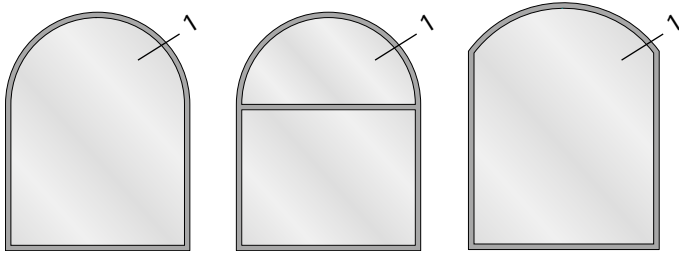

Profil	Min. Radius
Profilé	Rayon min.
Profile	Min. radius
	R

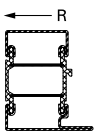

681.635 Z	700 mm
681.655 Z	750 mm

Andere Profiltypen sowie im Grundriss gebogene Profile auf Anfrage.

Autres types de profilés et profilés au tracé cintré sur demande.

Die Radien-Angaben beziehen sich auf die Fertigung im Hause Jansen.

Les rayons indiqués concernent la fabrication des cintres par la société Jansen.

Stahl-Glasleisten	Min. Radius
Parcloses en acier	Rayon min.
Steel glazing beads	Min. radius
	R



402.112 Z	500 mm
402.115 Z	500 mm
402.120 Z	600 mm
402.125 Z	750 mm
402.130 Z	1000 mm
402.136 Z	500 mm
402.141 Z	500 mm

Stahl-Glasleisten	Min. Radius
Parcloses en acier	Rayon min.
Steel glazing beads	Min. radius
	R



62.507 Z	300 mm
62.508 Z	300 mm
62.509 Z	300 mm

Aluminium-Glasleisten	Min. Radius
Parcloses en aluminium	Rayon min.
Aluminium glazing beads	Min. radius
	R



404.112	400 mm
404.115	400 mm
404.120	400 mm
404.125	450 mm
404.130	500 mm
404.135	600 mm

Other profile types and profiles curved in the floor plan are available on request.

The radius information refers to the production of the arches at the Jansen.

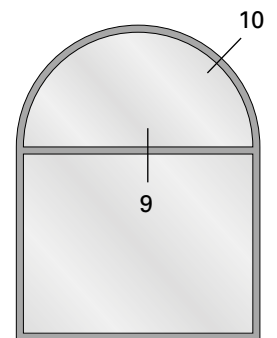
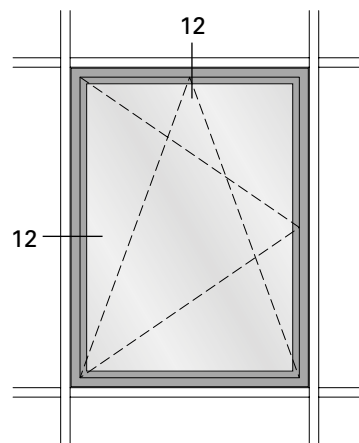
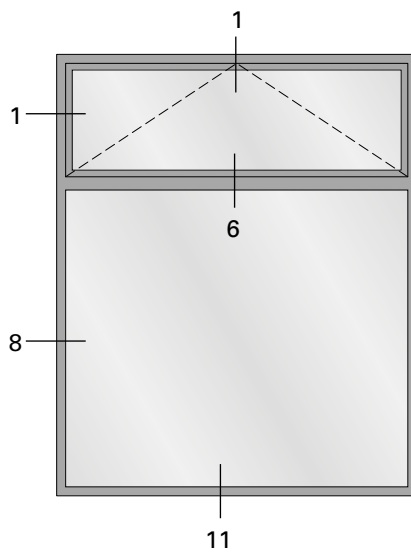
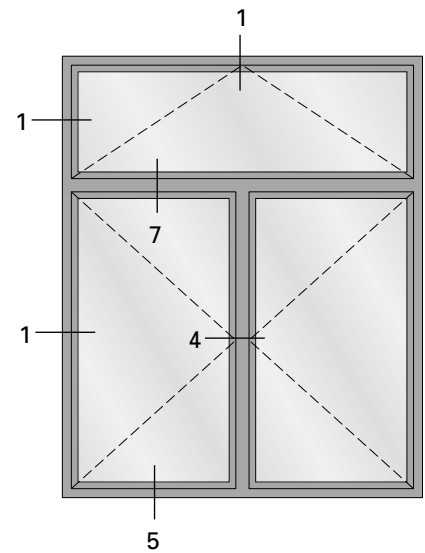
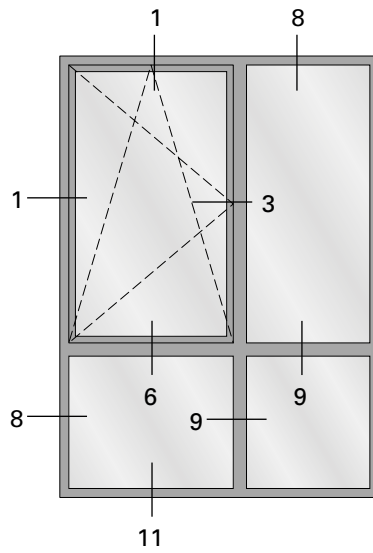
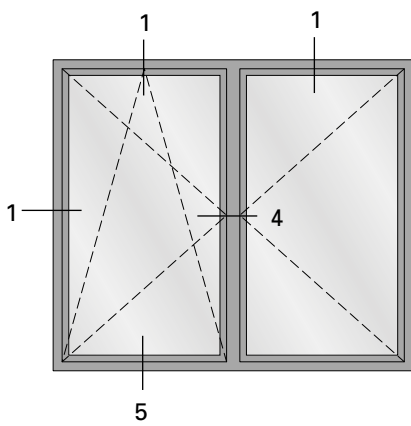
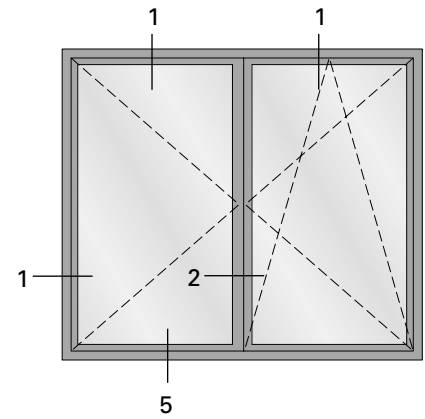
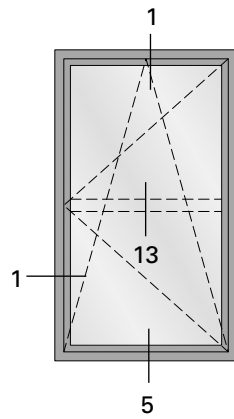
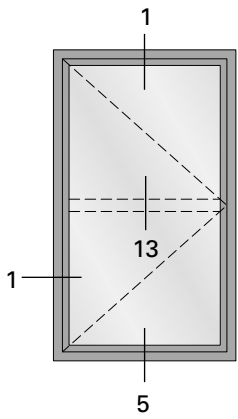

1.0

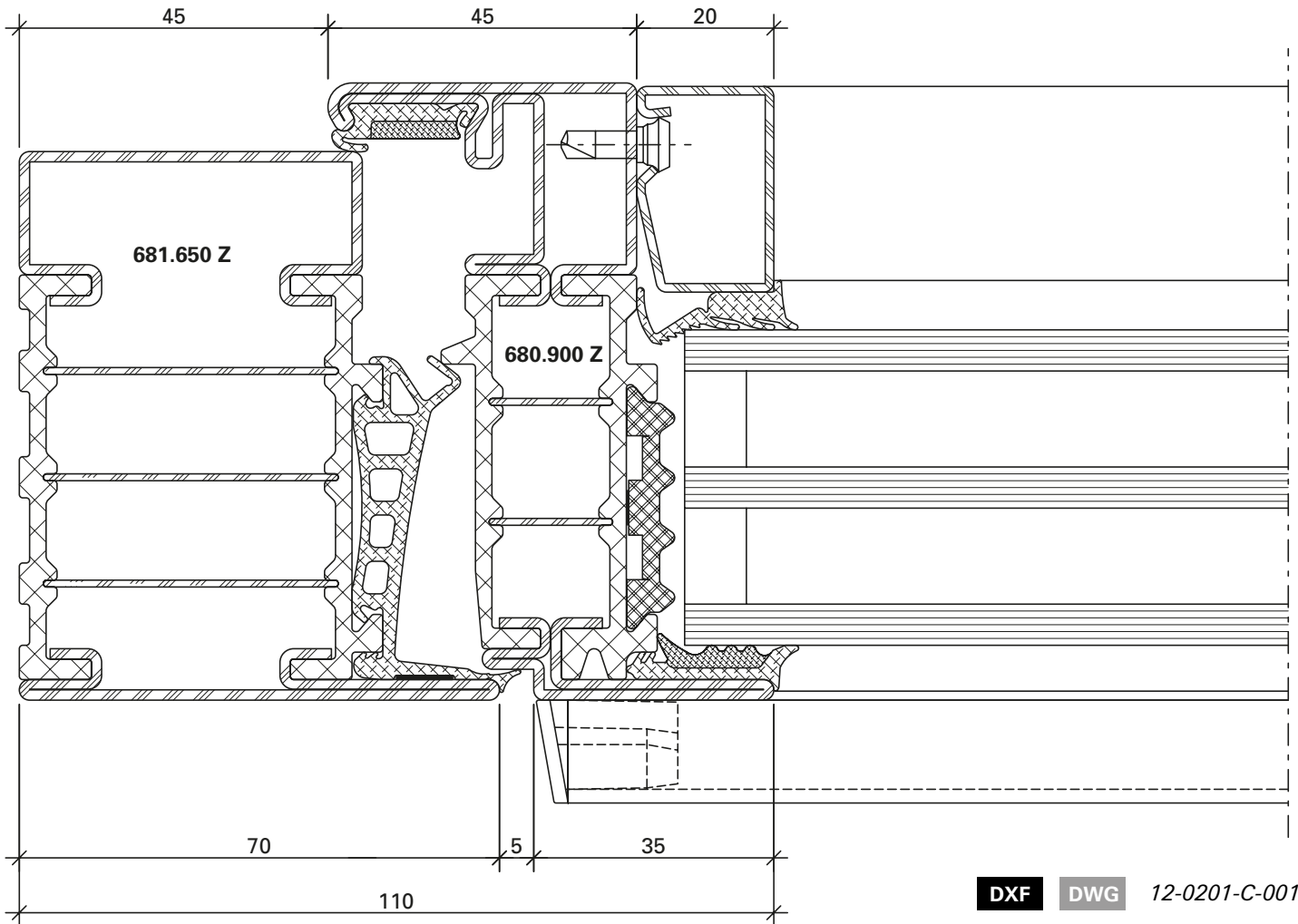

1.1

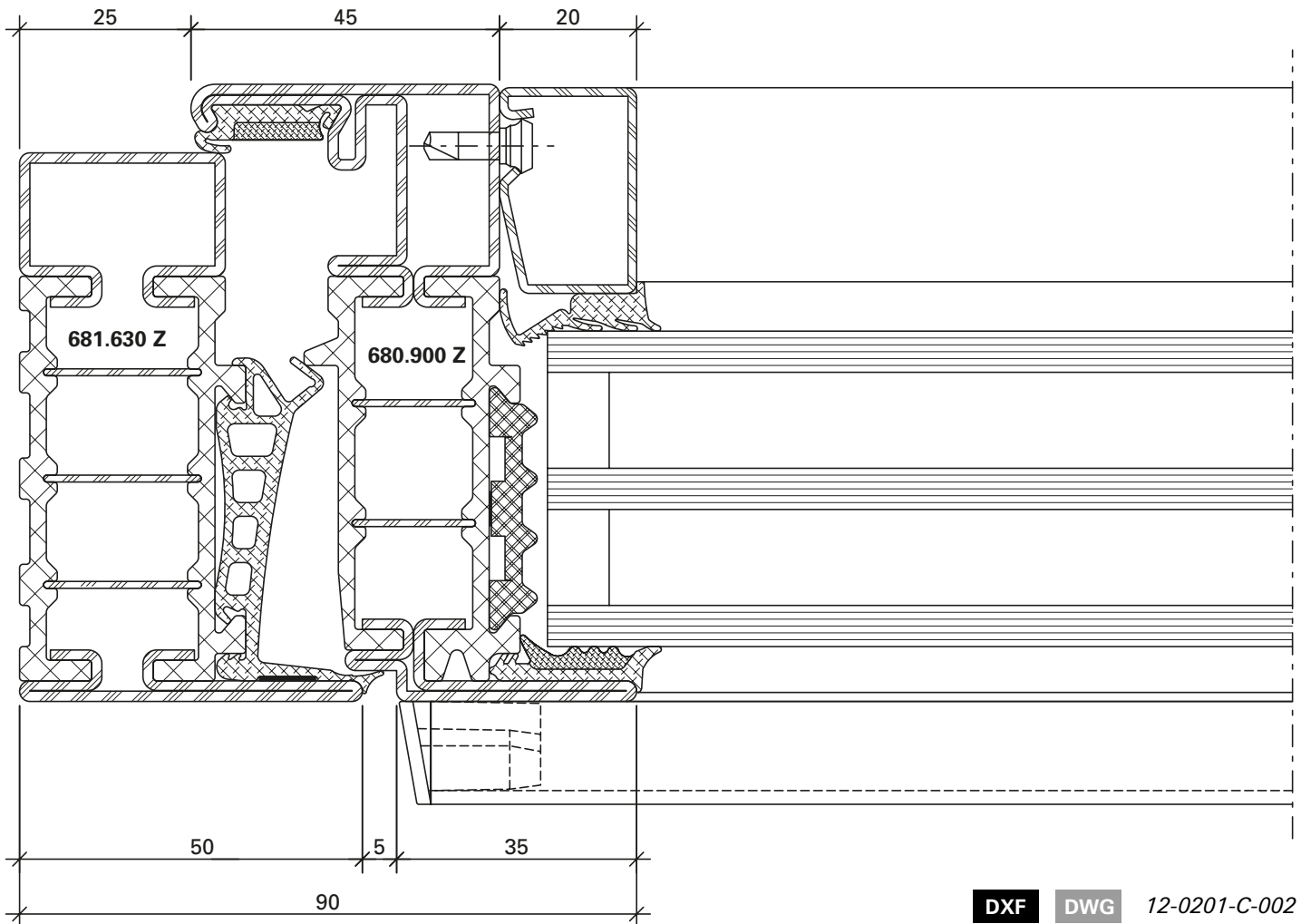

DXF

DWG

12-0201-C-002

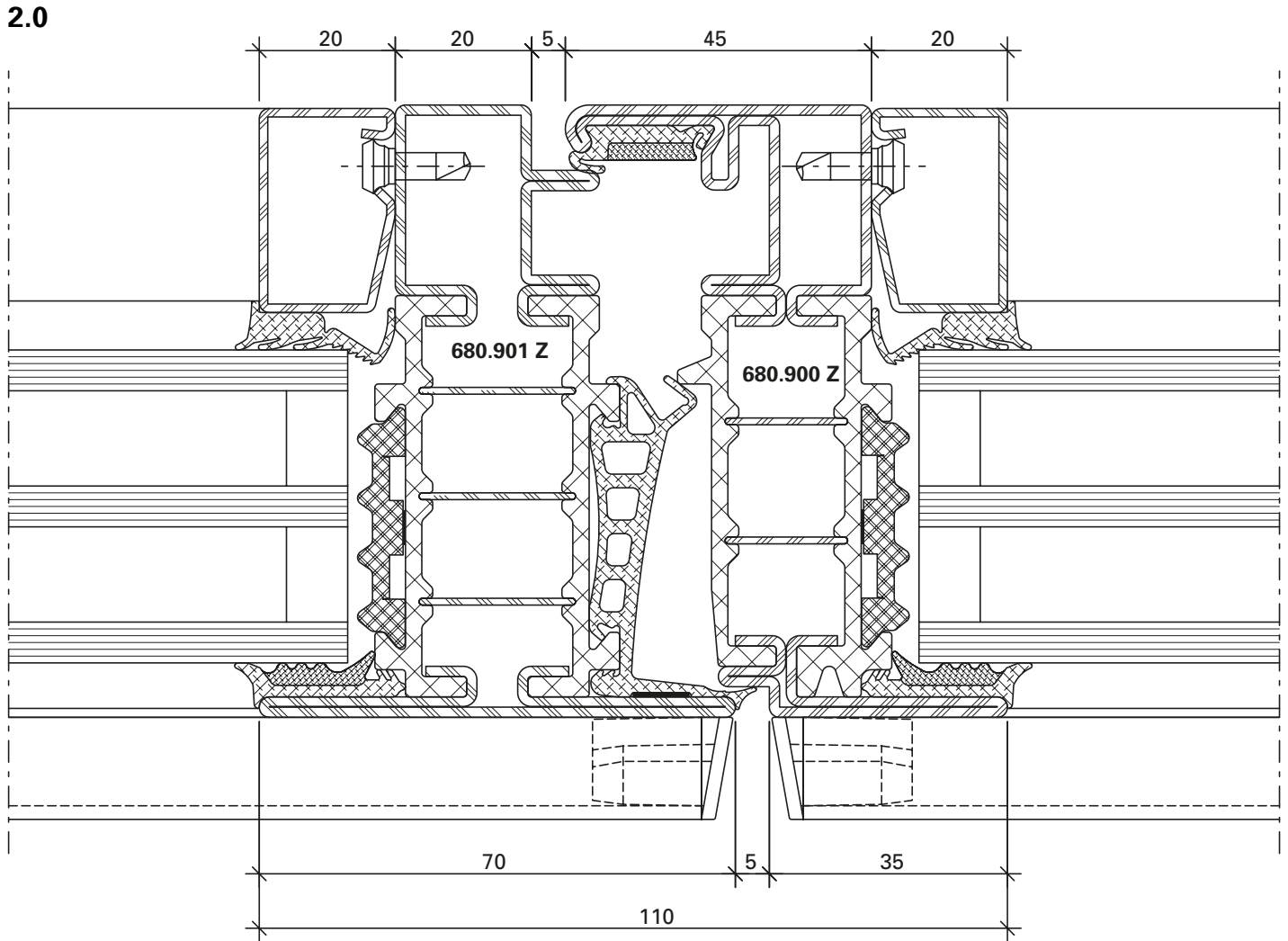

DXF DWG 12-0201-C-007

3.0

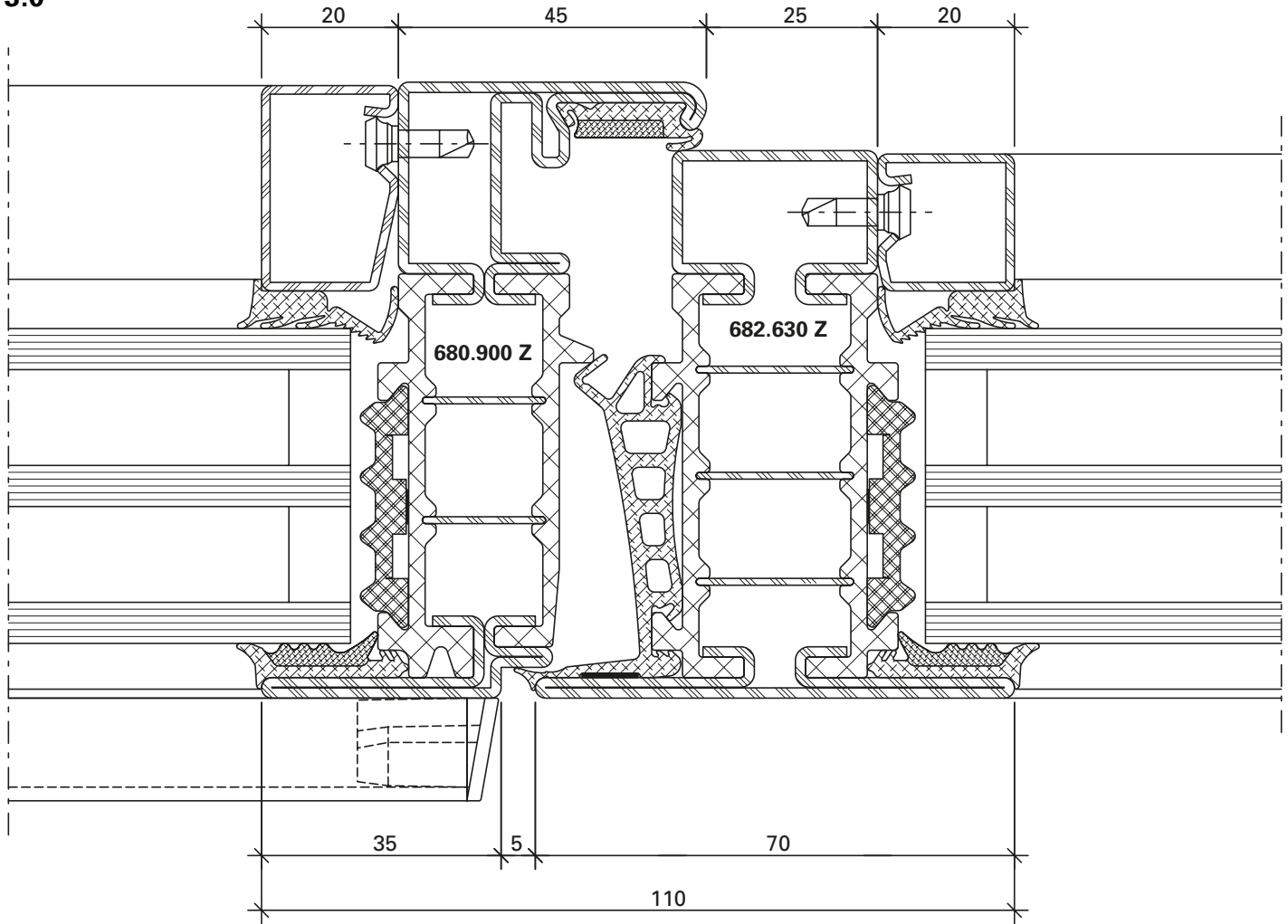

DXF

DWG

12-0201-C-004

4.0

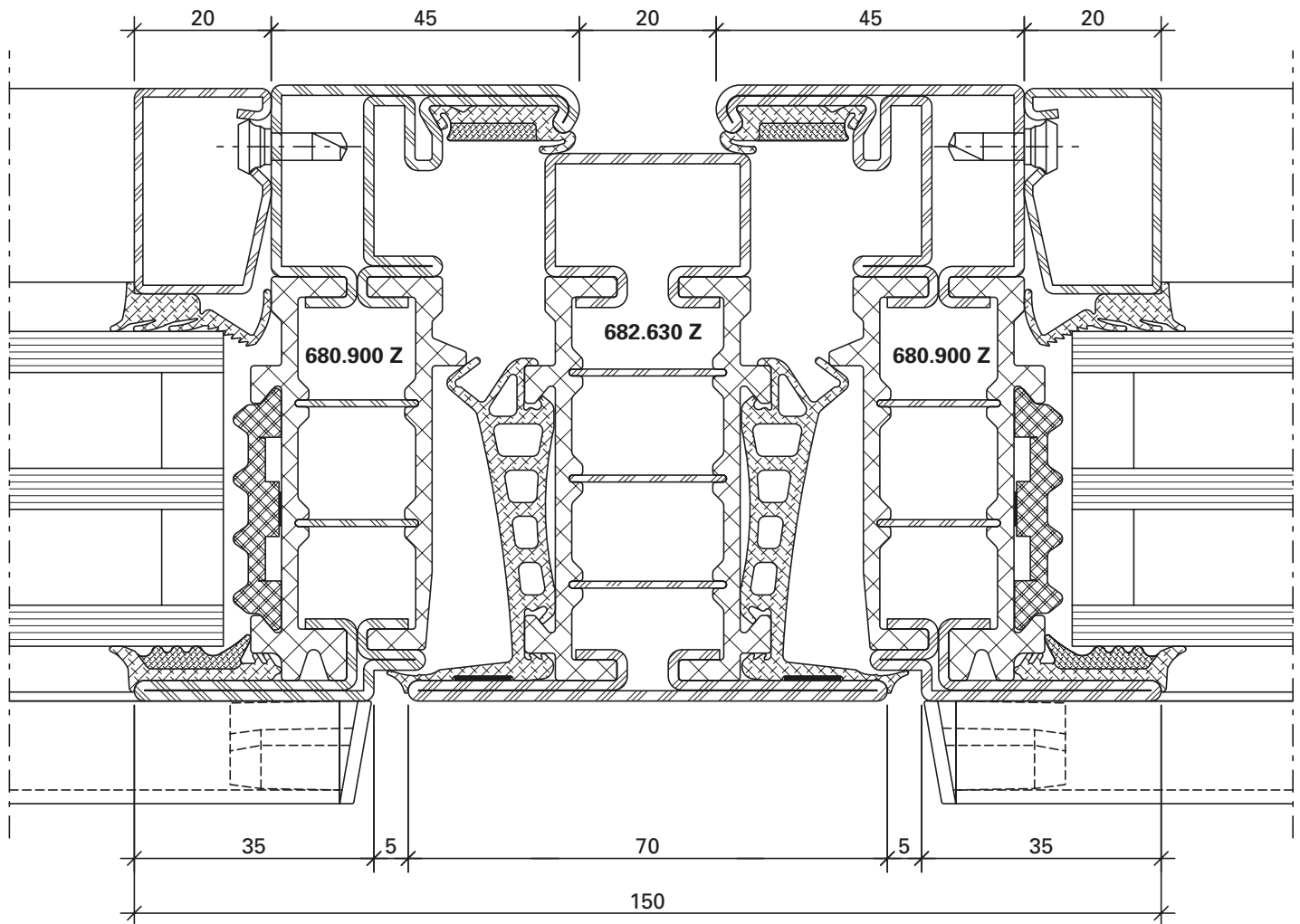

DXF DWG 12-0201-C-006

13.0

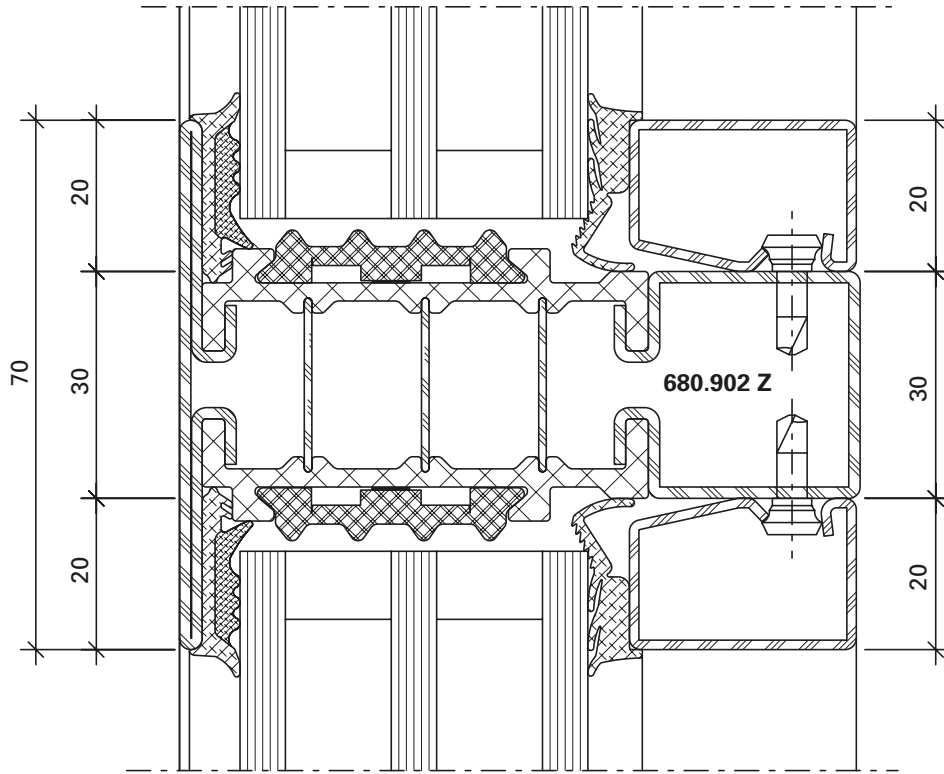

12-0201-C-020

DWG

DXF

5.0

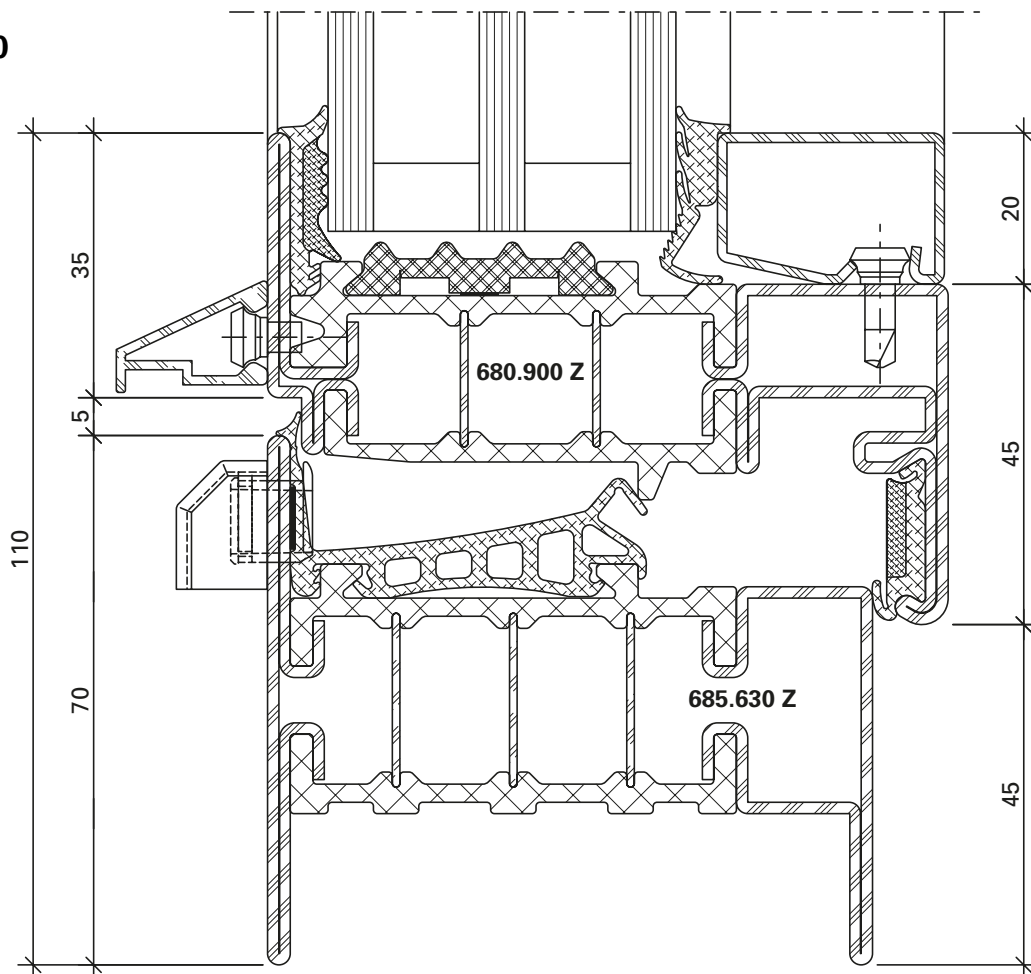

12-0201-C-009

DWG

DXF

6.0

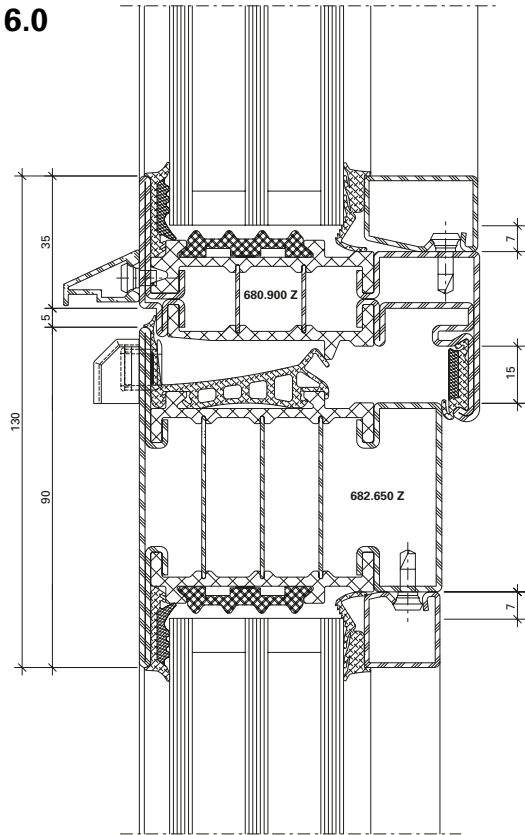

DWG 12-0201-C-016

DWG

DXF

6.1

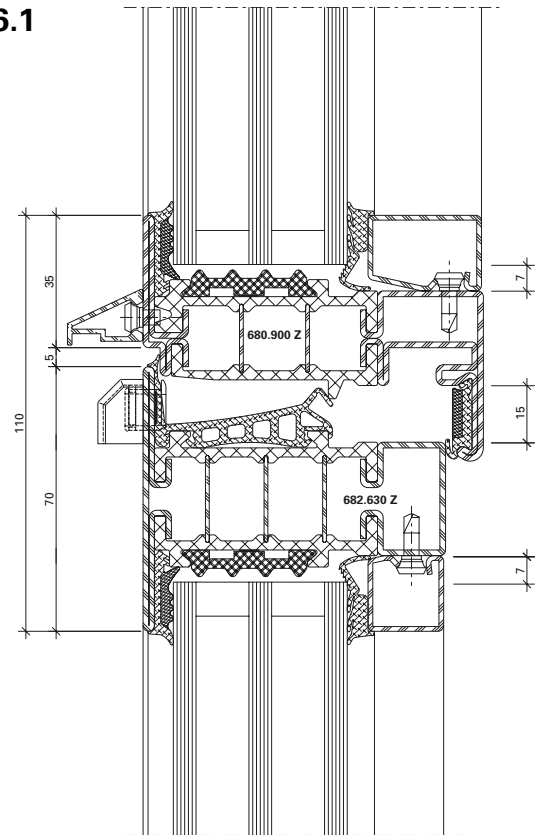

DWG 12-0201-C-019

DWG

DXF

7.0

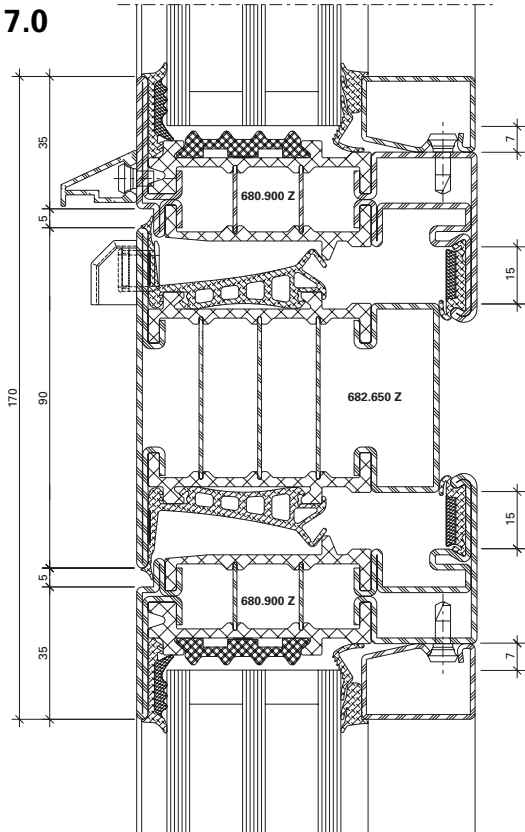

DWG 12-0201-C-018

DWG

DXF

5.1

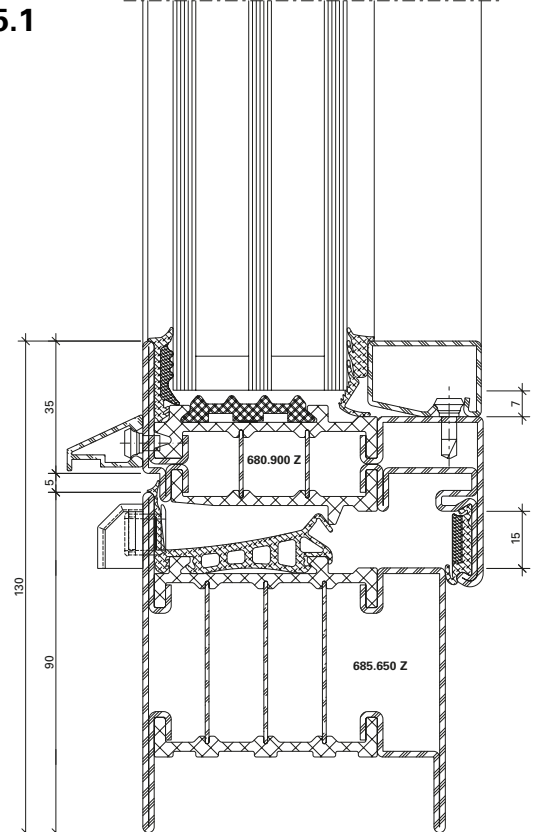

DWG 12-0201-C-008

DWG

DXF

8.0

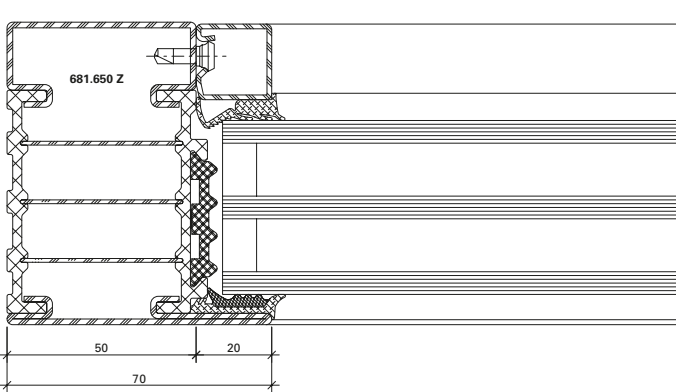

DXF

DWG

12-0201-C-012

9.0

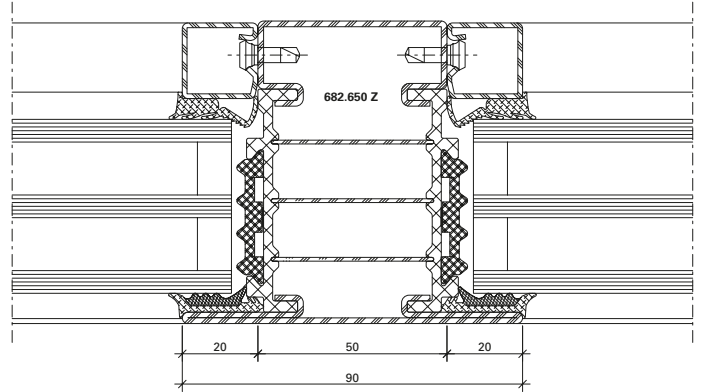

DXF

DWG

12-0201-C-014

8.1

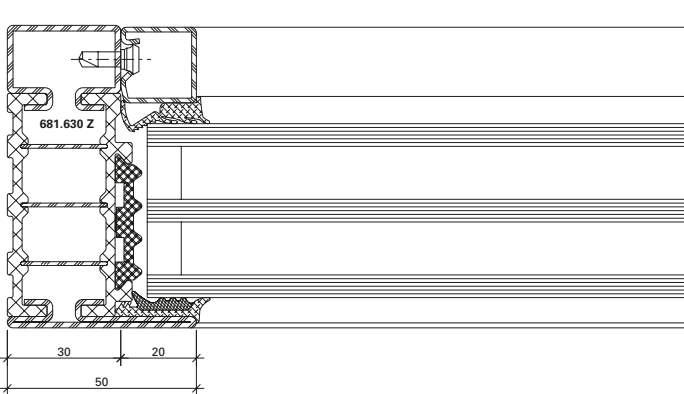

DXF

DWG

12-0201-C-013

9.1

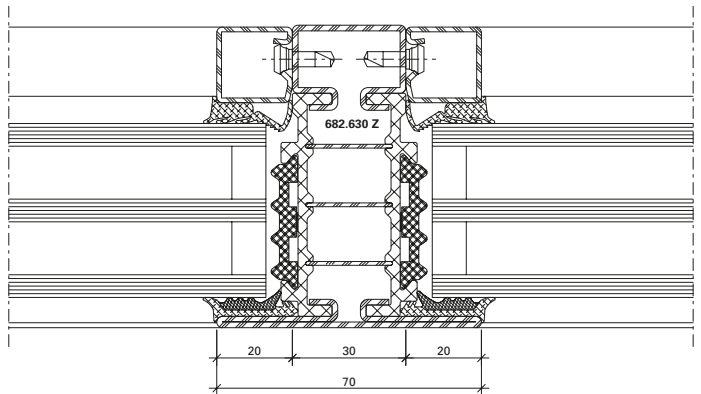

DXF

DWG

12-0201-C-015

10.0

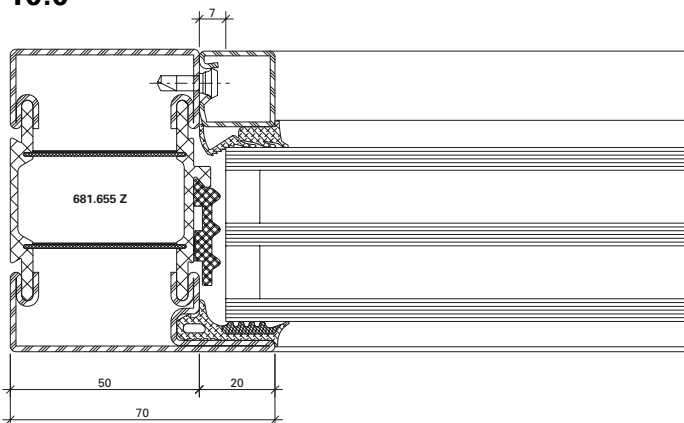

DXF

DWG

12-0204-C-003

10.1

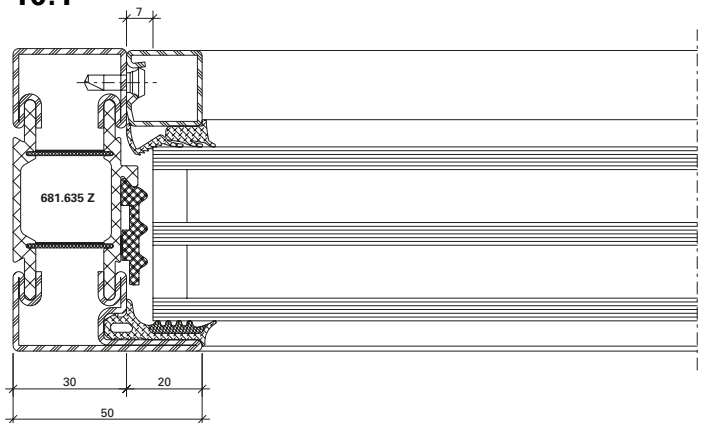

DXF

DWG

12-0204-C-004

3.1

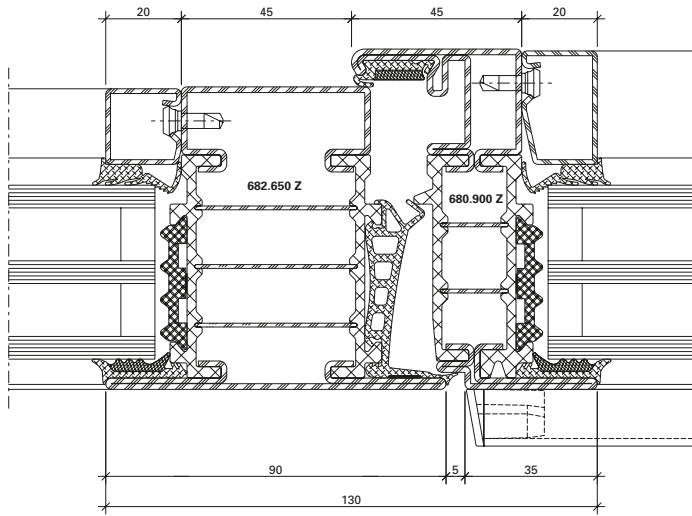

DXF **DWG** 12-0201-C-003

4.1

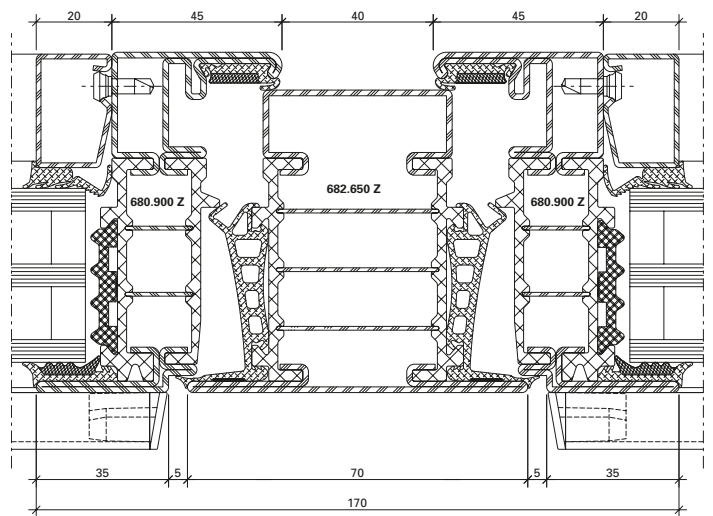

DXF **DWG** 12-0201-C-005

1.3

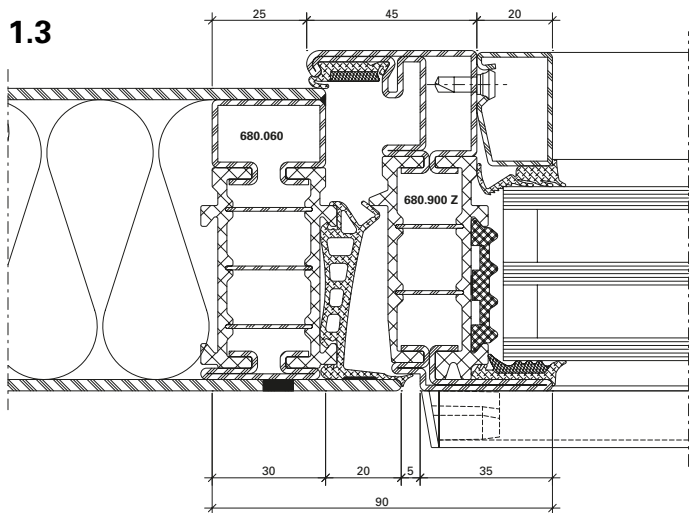

DXF **DWG** 12-0201-C-021

8.2

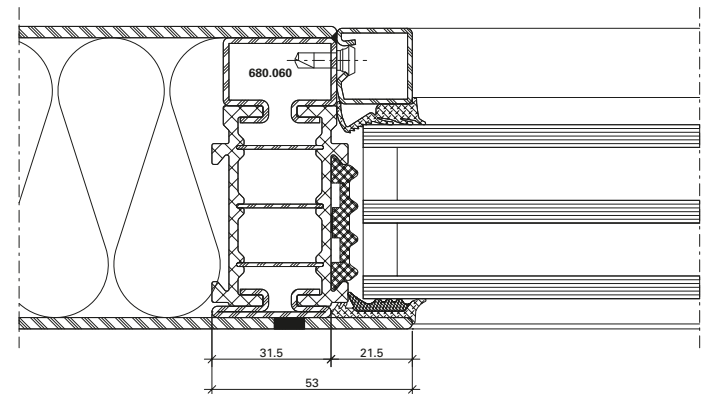

DXF **DWG** 12-0201-C-022

9.2

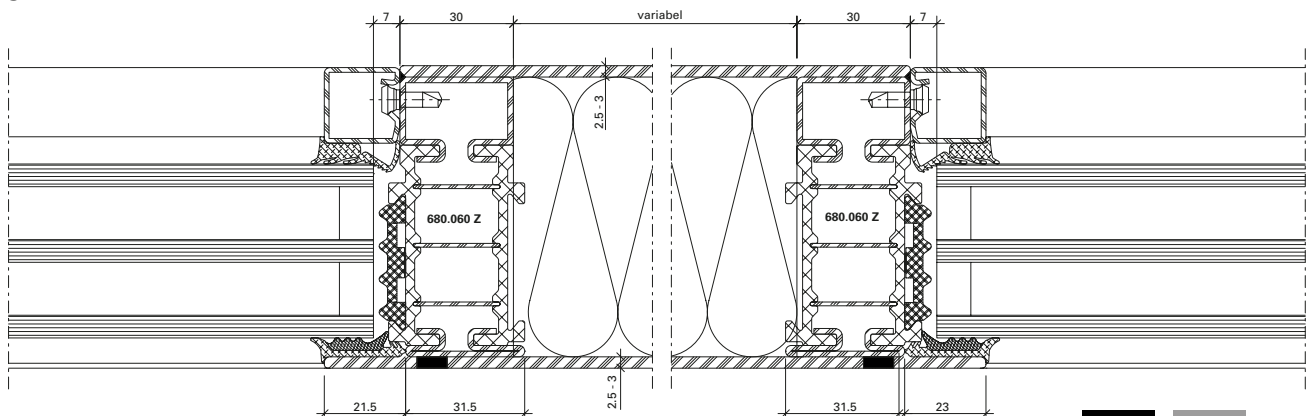

DXF **DWG** 12-0102-C-065

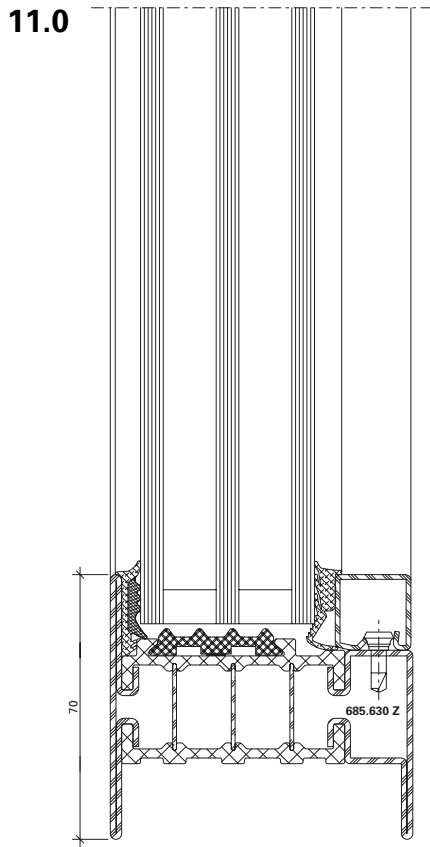

DXF 12-0201-C-011
 DWG

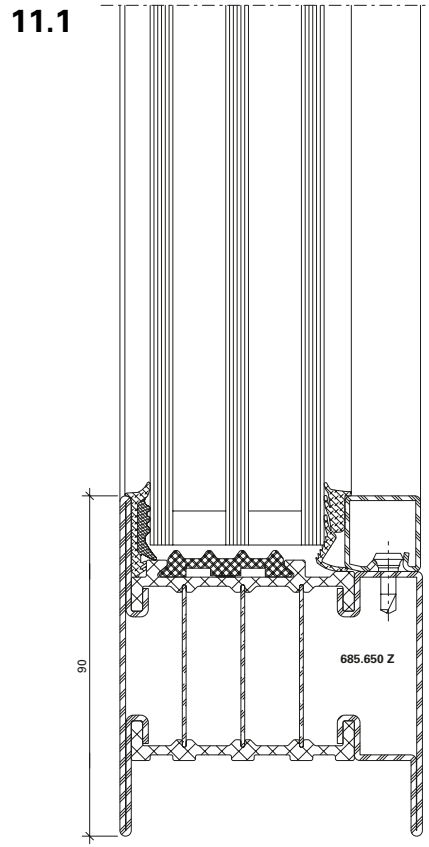

DXF 12-0201-C-010
 DWG

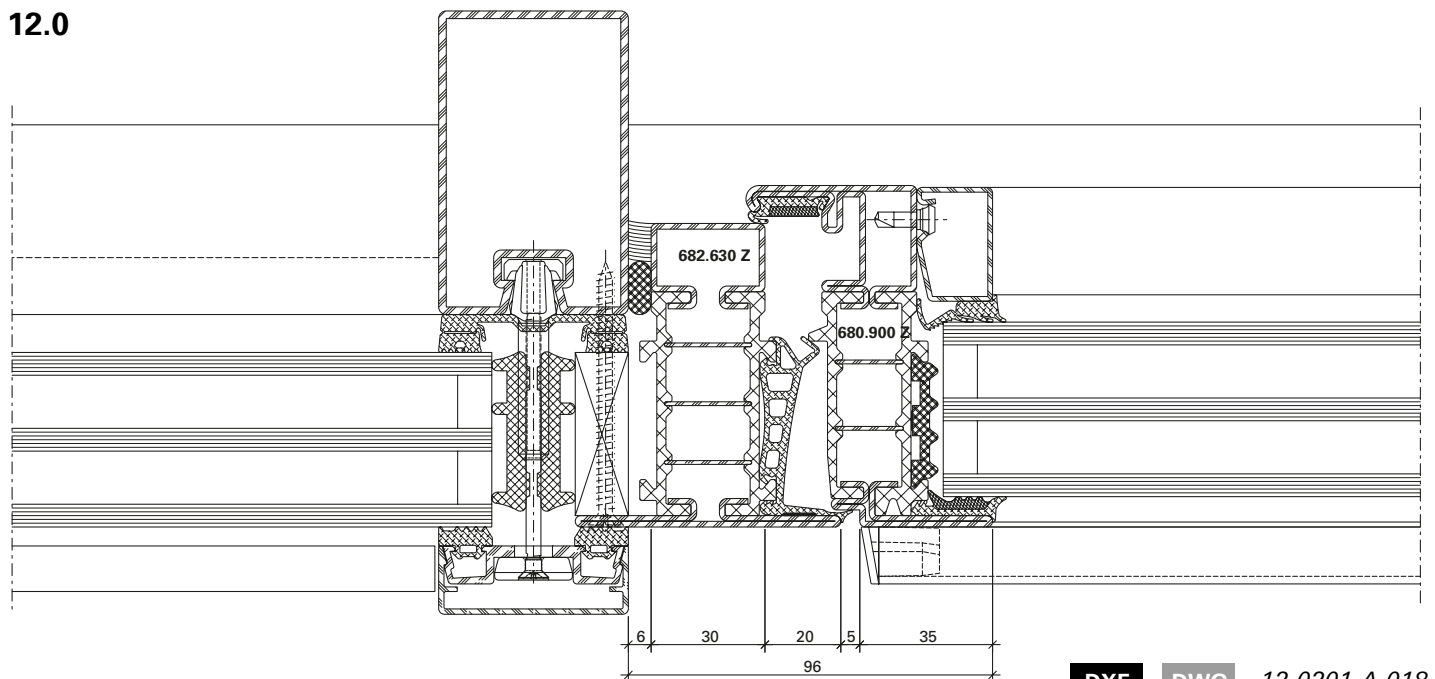

DXF DWG 12-0201-A-018

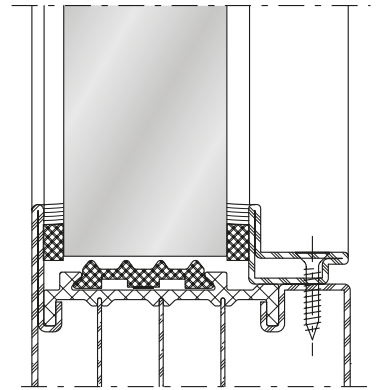
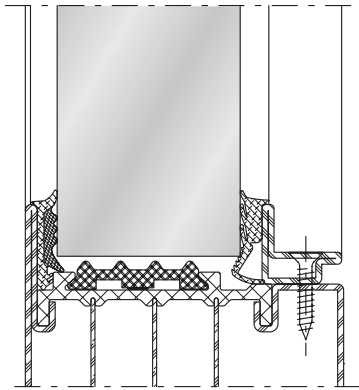
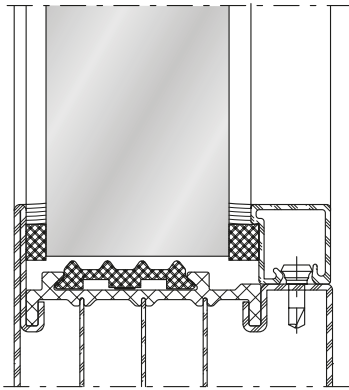
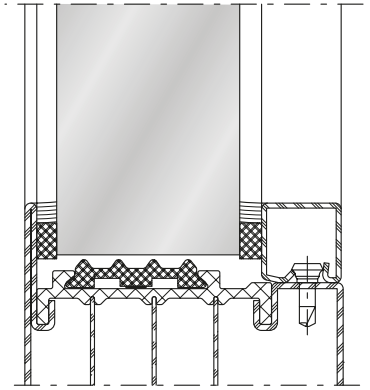
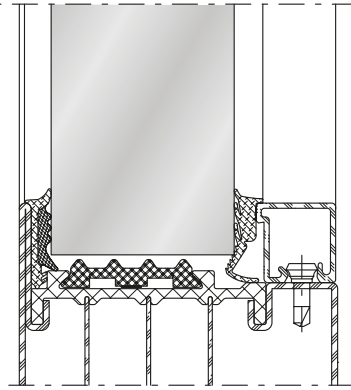
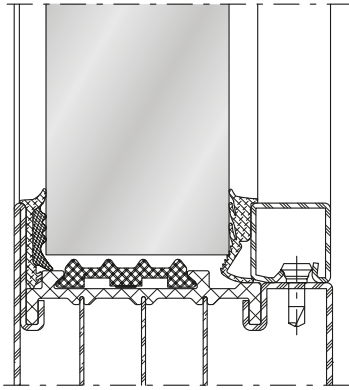

Platzbedarf
Standard-Fensterbeschlag
Bei Öffnungswinkel 90°

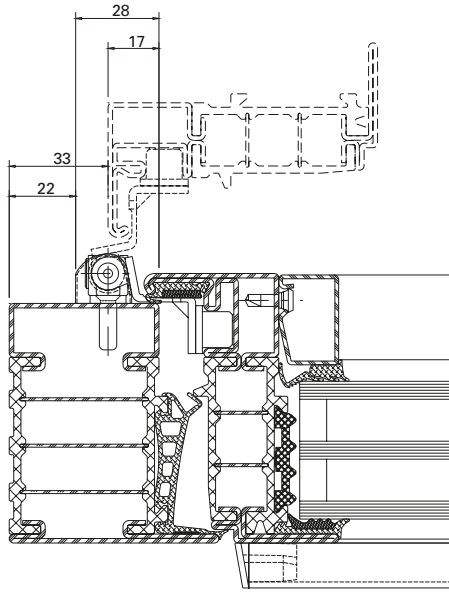

Espace nécessaire
Ferrure de fenêtre standard
À l'angle d'ouverture 90°

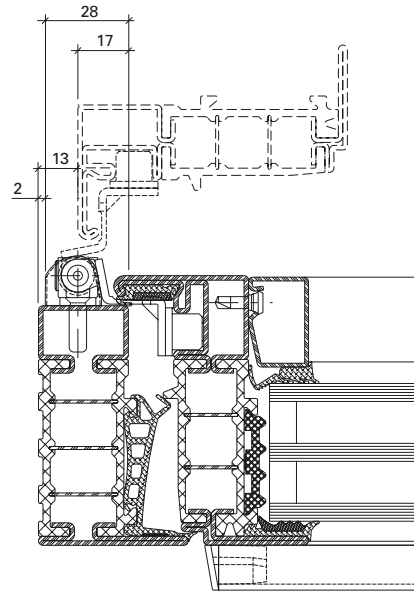

Space required
Standard window fitting
At opening angle 90°

Platzbedarf
Verdeckt liegender Fensterbeschlag
Bei Öffnungswinkel 90°

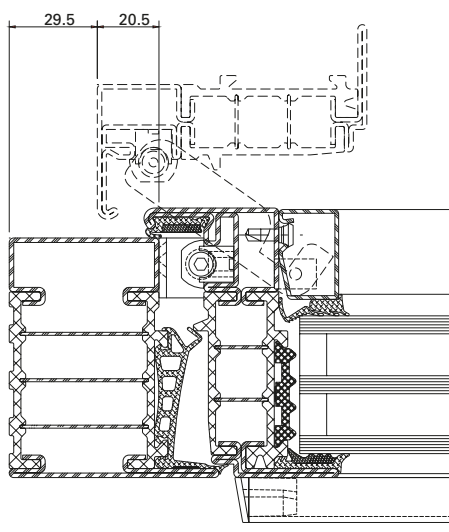

Espace nécessaire
Ferrure de fenêtre non apparente
À l'angle d'ouverture 90°

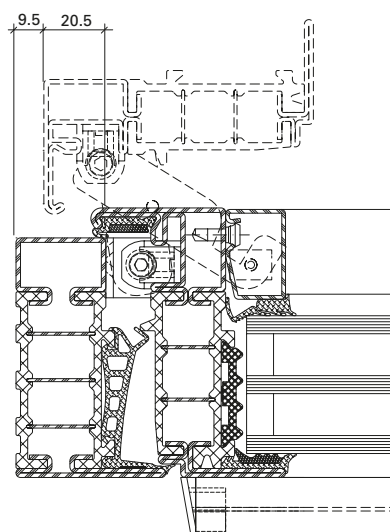

Space required
Concealed window fitting
At opening angle 90°

Platzbedarf
Standard-Fensterbeschlag
Bei Öffnungswinkel 90°

Espace nécessaire
Ferrure de fenêtre standard
À l'angle d'ouverture 90°

Space required
Standard window fitting
At opening angle 90°

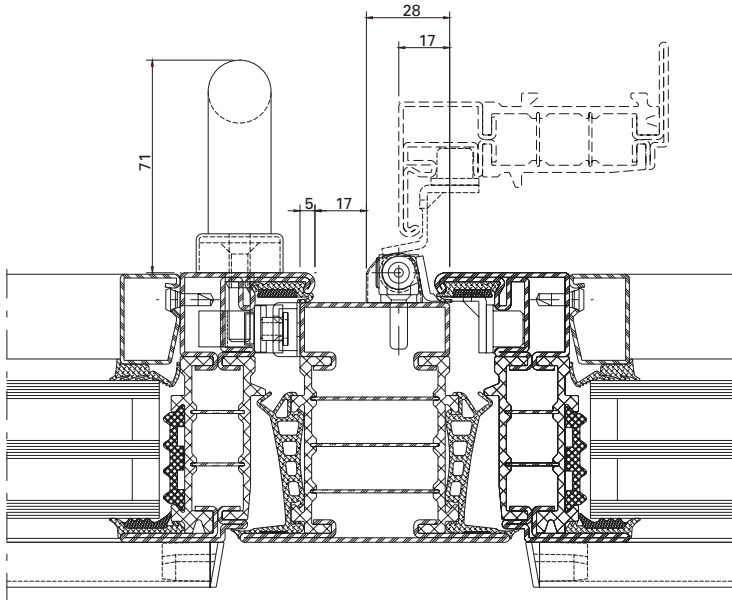

Platzbedarf
Verdeckt liegender Fensterbeschlag
Bei Öffnungswinkel 90°

Espace nécessaire
Ferrure de fenêtre non apparente
À l'angle d'ouverture 90°

Space required
Concealed window fitting
At opening angle 90°

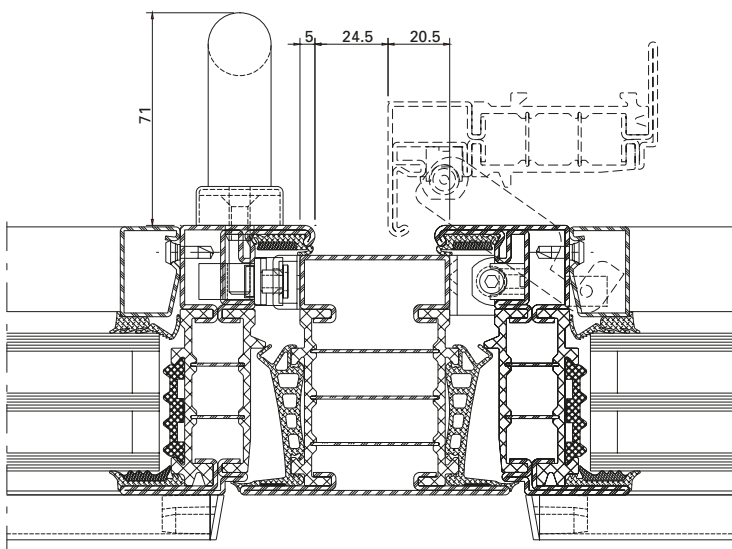

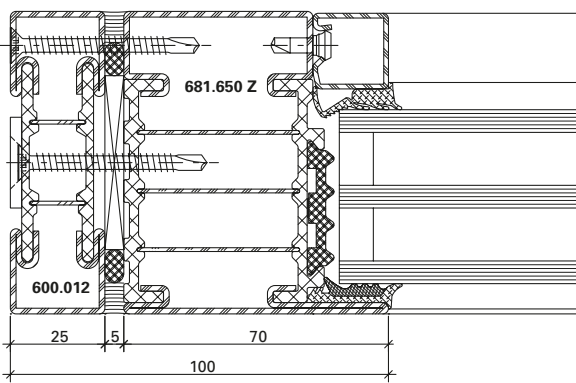

DXF **DWG** 12-0201-K-001

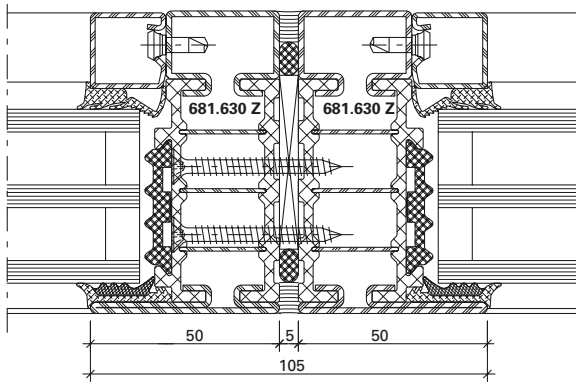

DXF **DWG** 12-0201-K-002

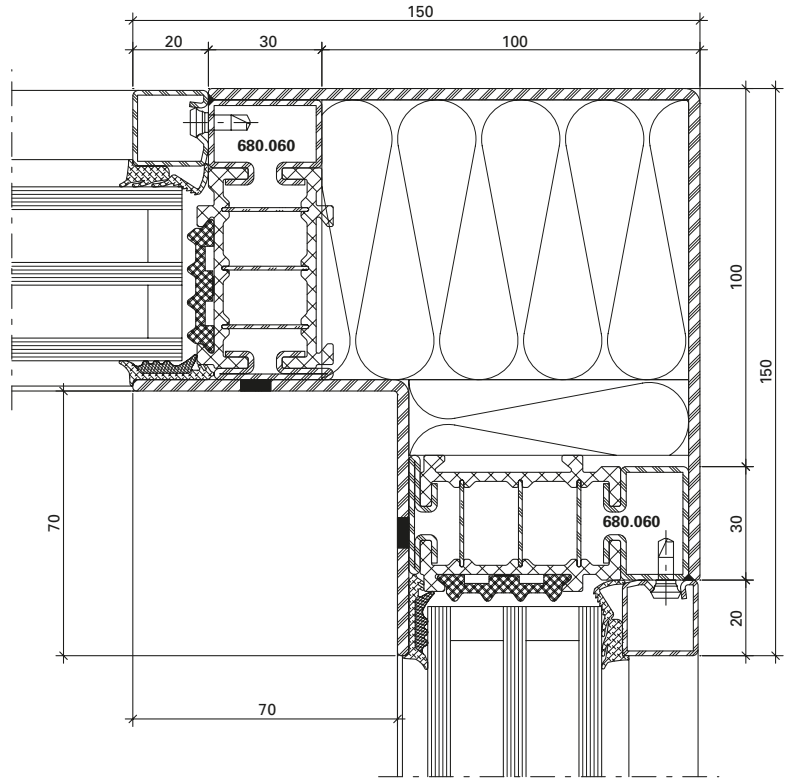

DXF **DWG** 12-0201-K-005

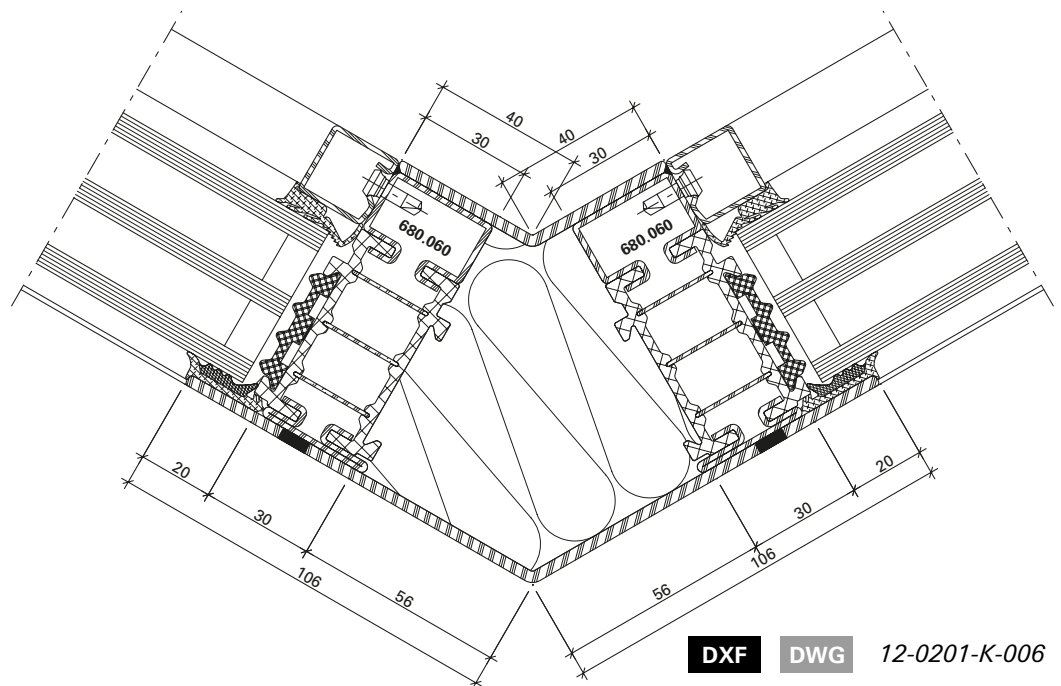

DXF **DWG** 12-0201-K-006

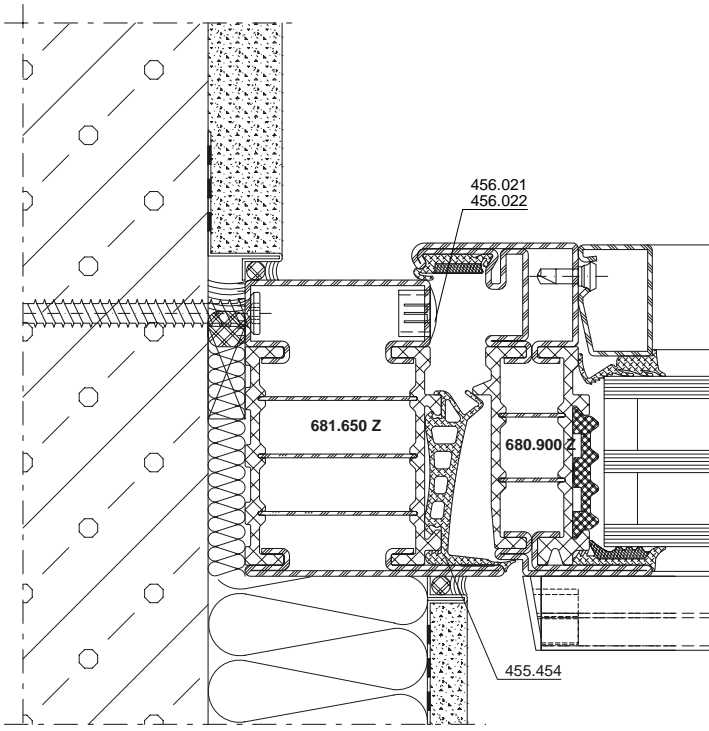

DXF **DWG** 12-0201-A-037

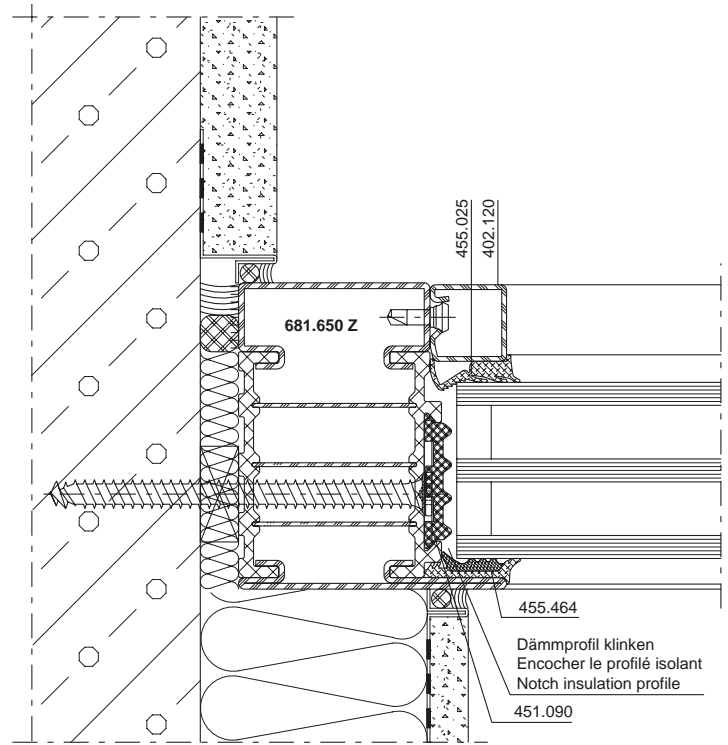

DXF **DWG** 12-0201-A-038

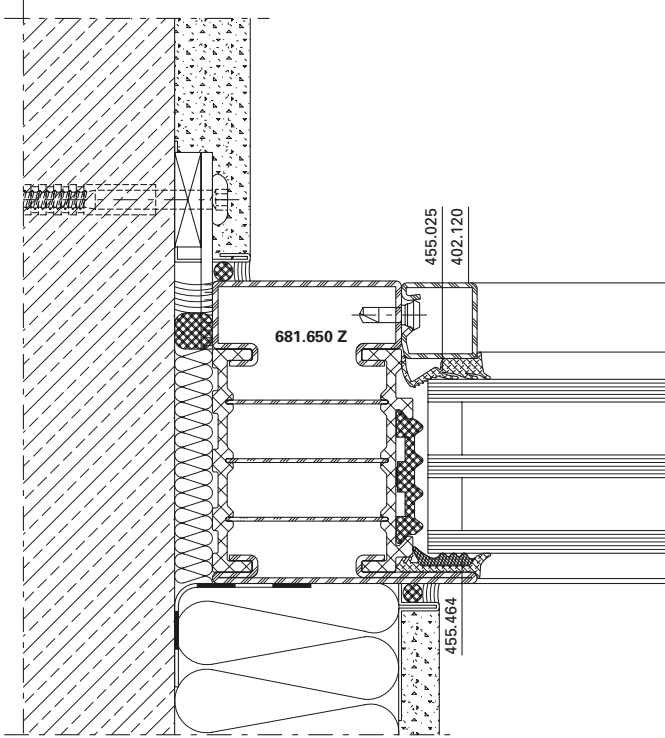

DXF DWG 12-0201-A-002

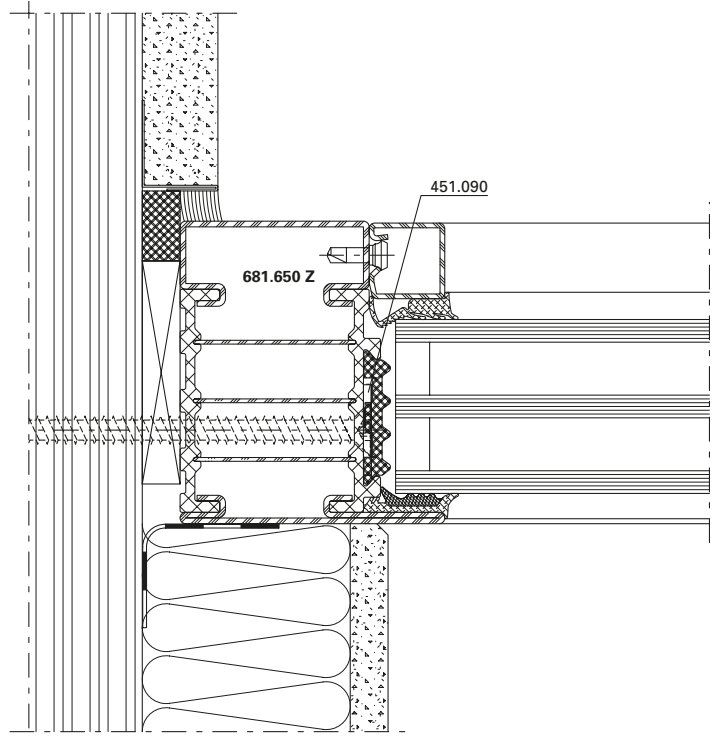

DXF DWG 12-0201-A-016

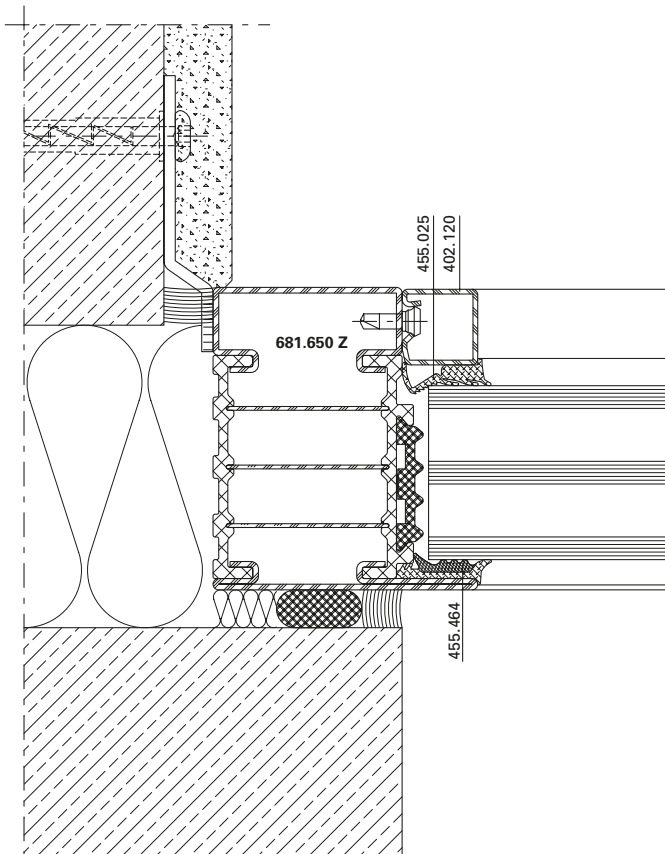

DXF DWG 12-0201-A-004

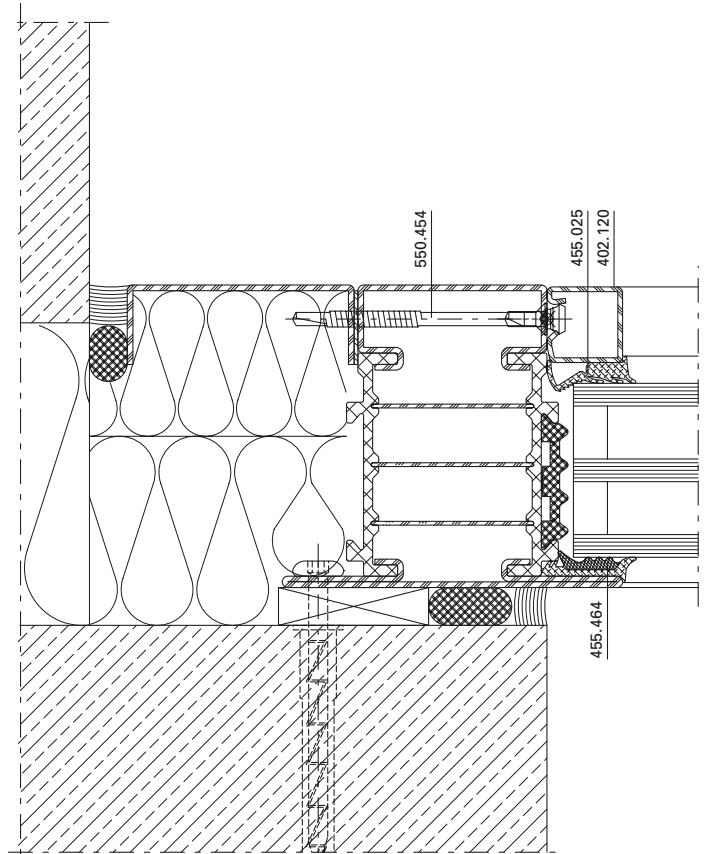

DXF DWG 12-0201-A-005

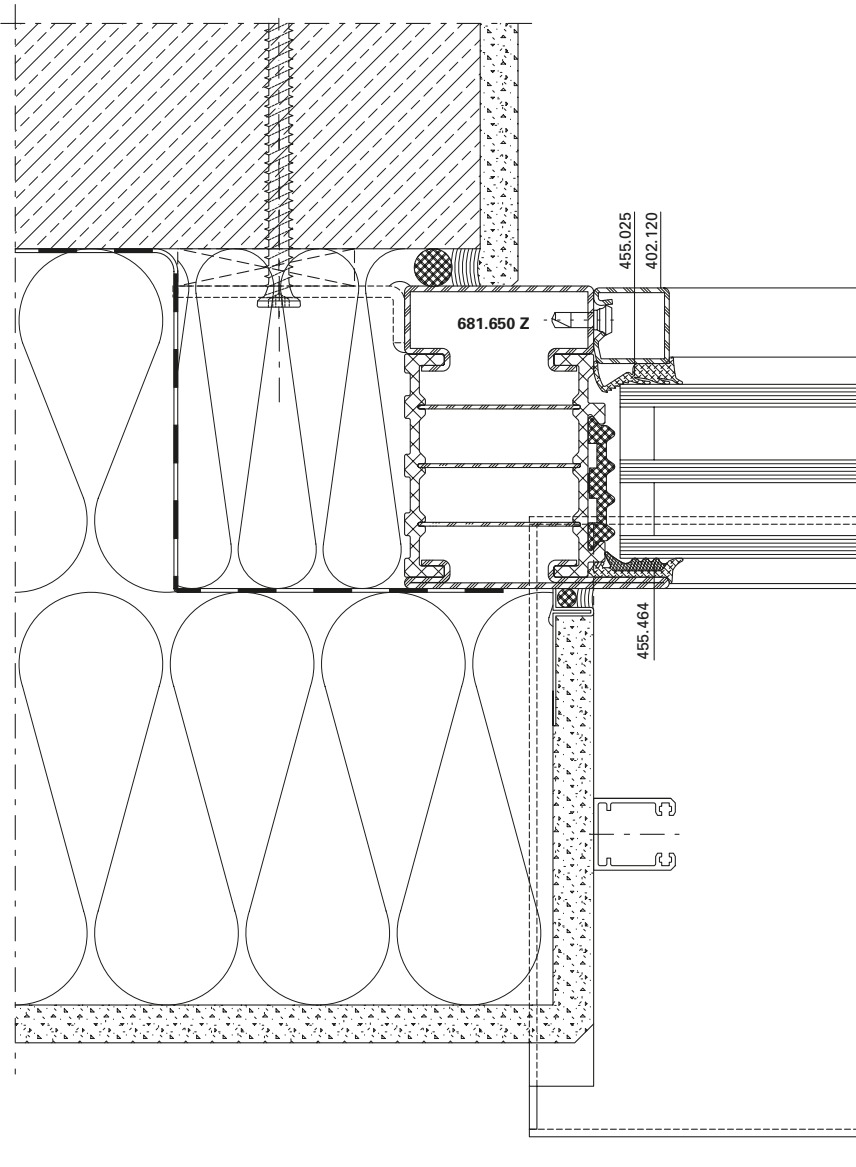

DXF **DWG** 12-0201-A-001

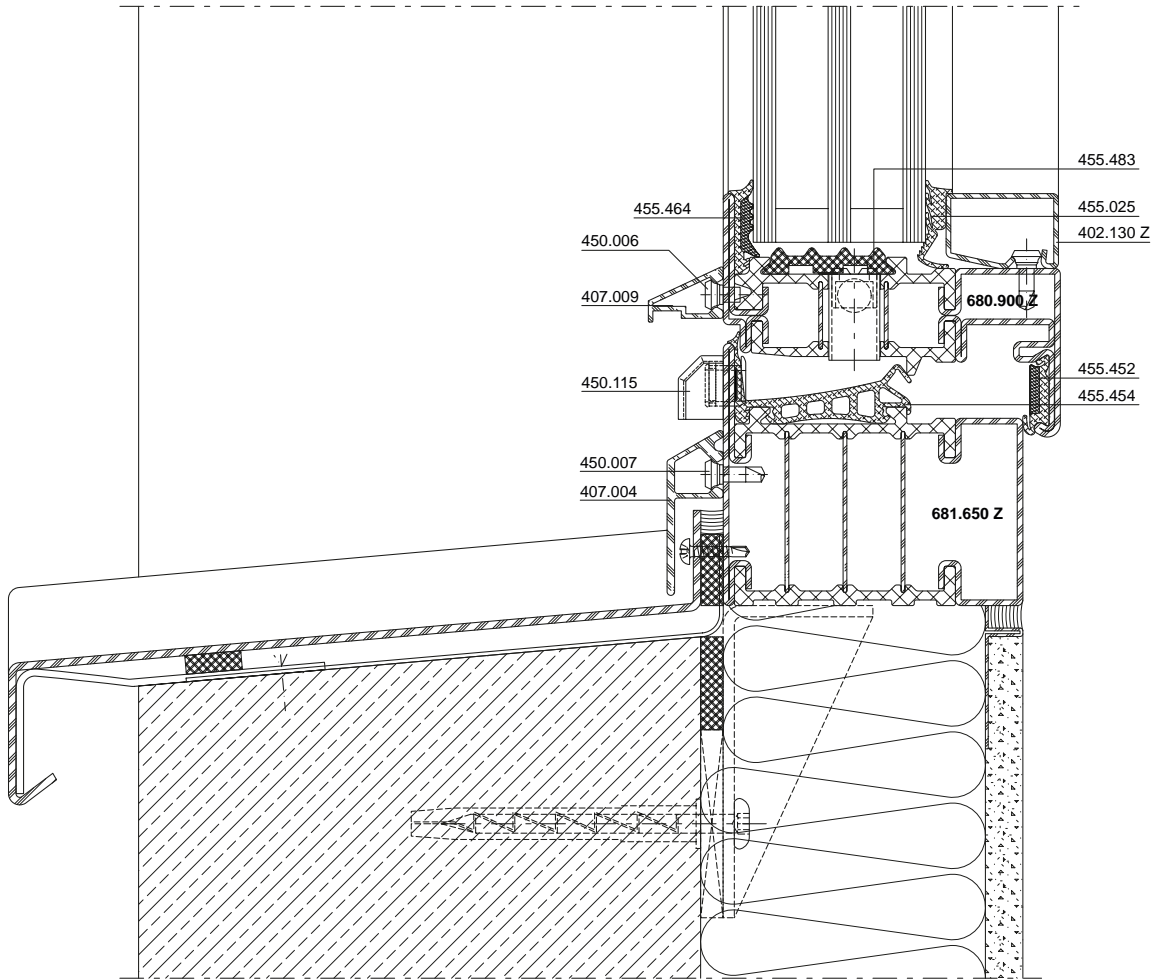

DXF

DWG

12-0201-A-014

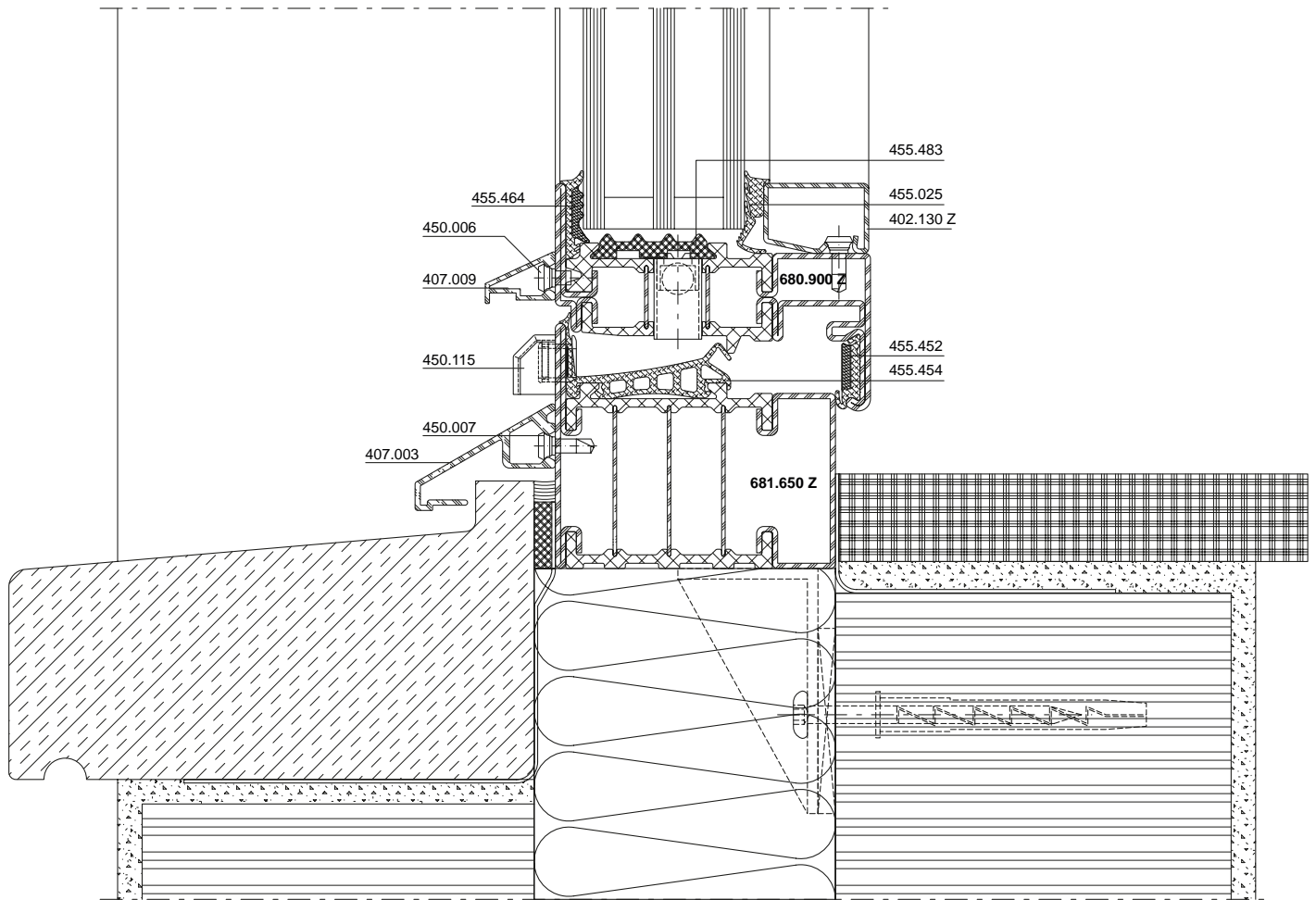

DXF

DWG

12-0201-A-012

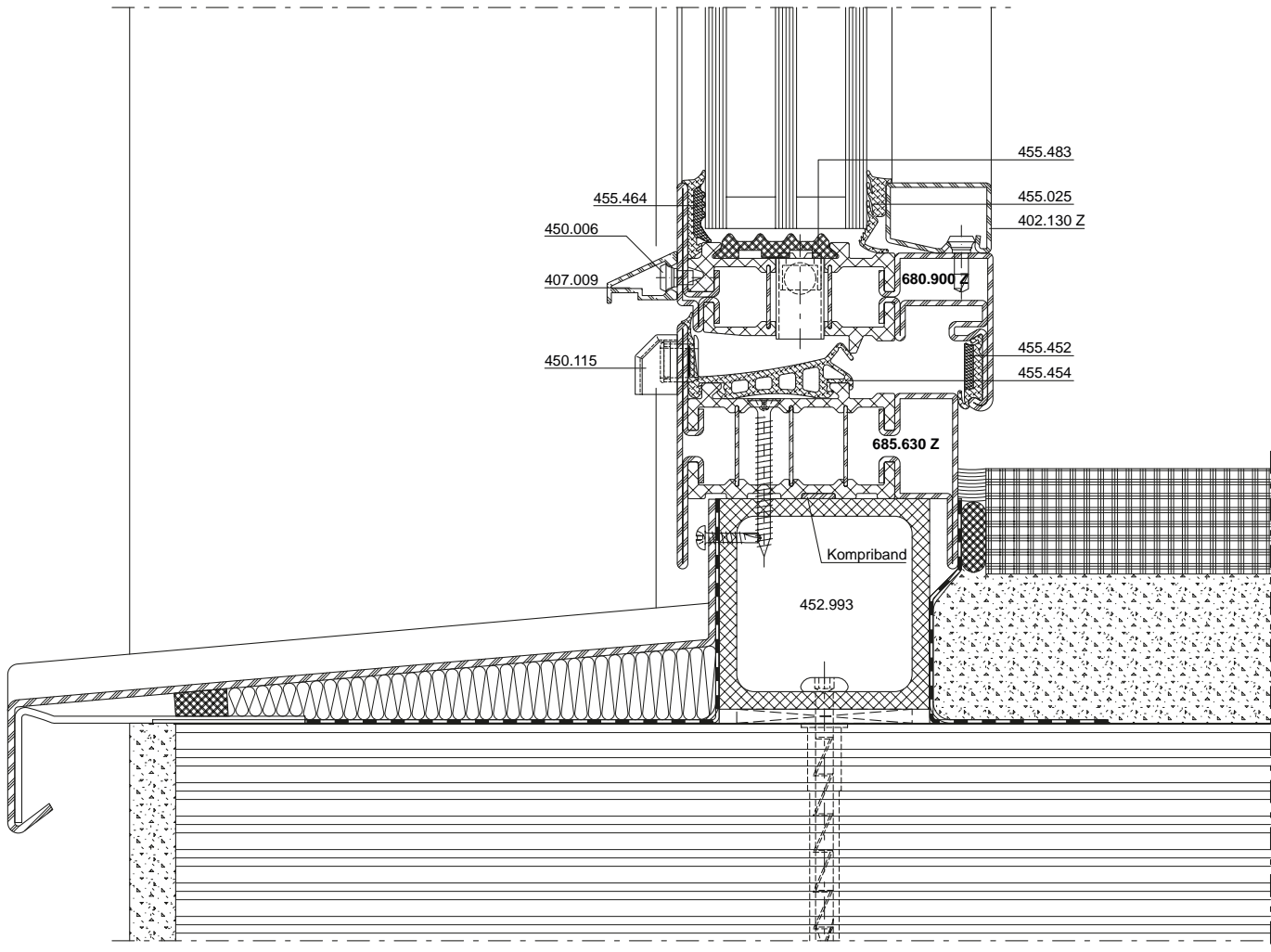

DXF DWG 12-0201-A-015

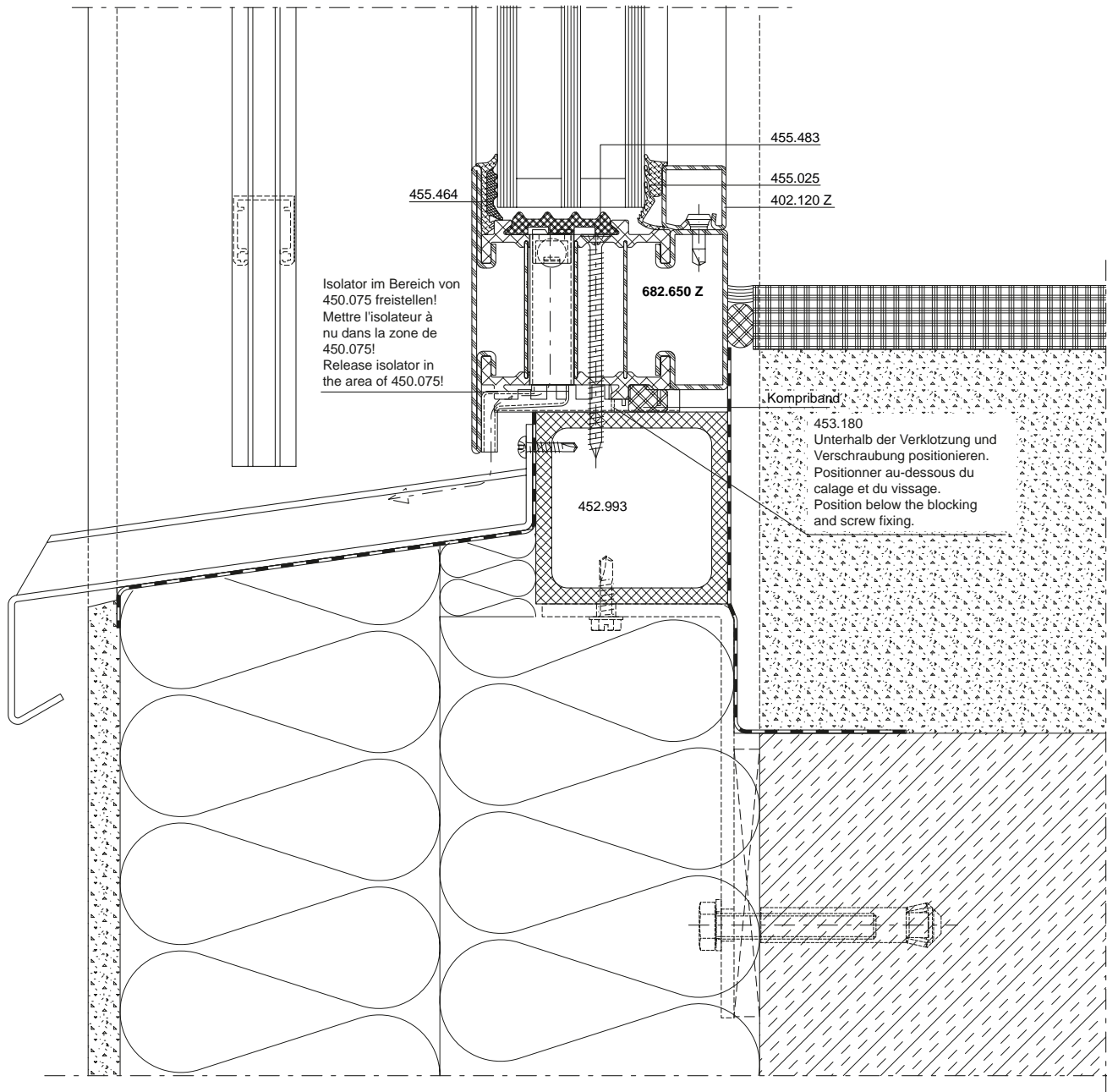

DXF

DWG

12-0201-A-006

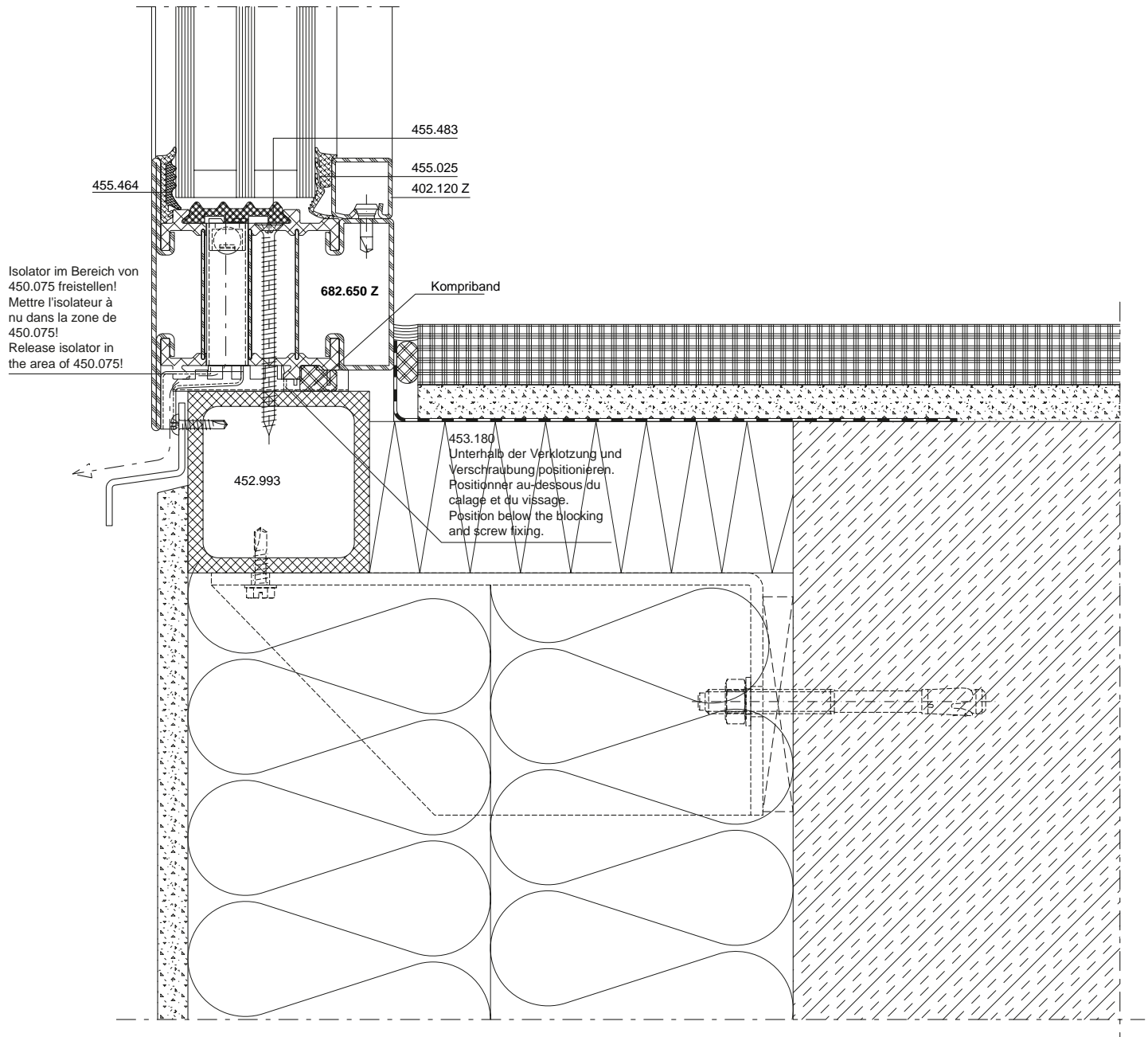

DXF

DWG

12-0201-A-008

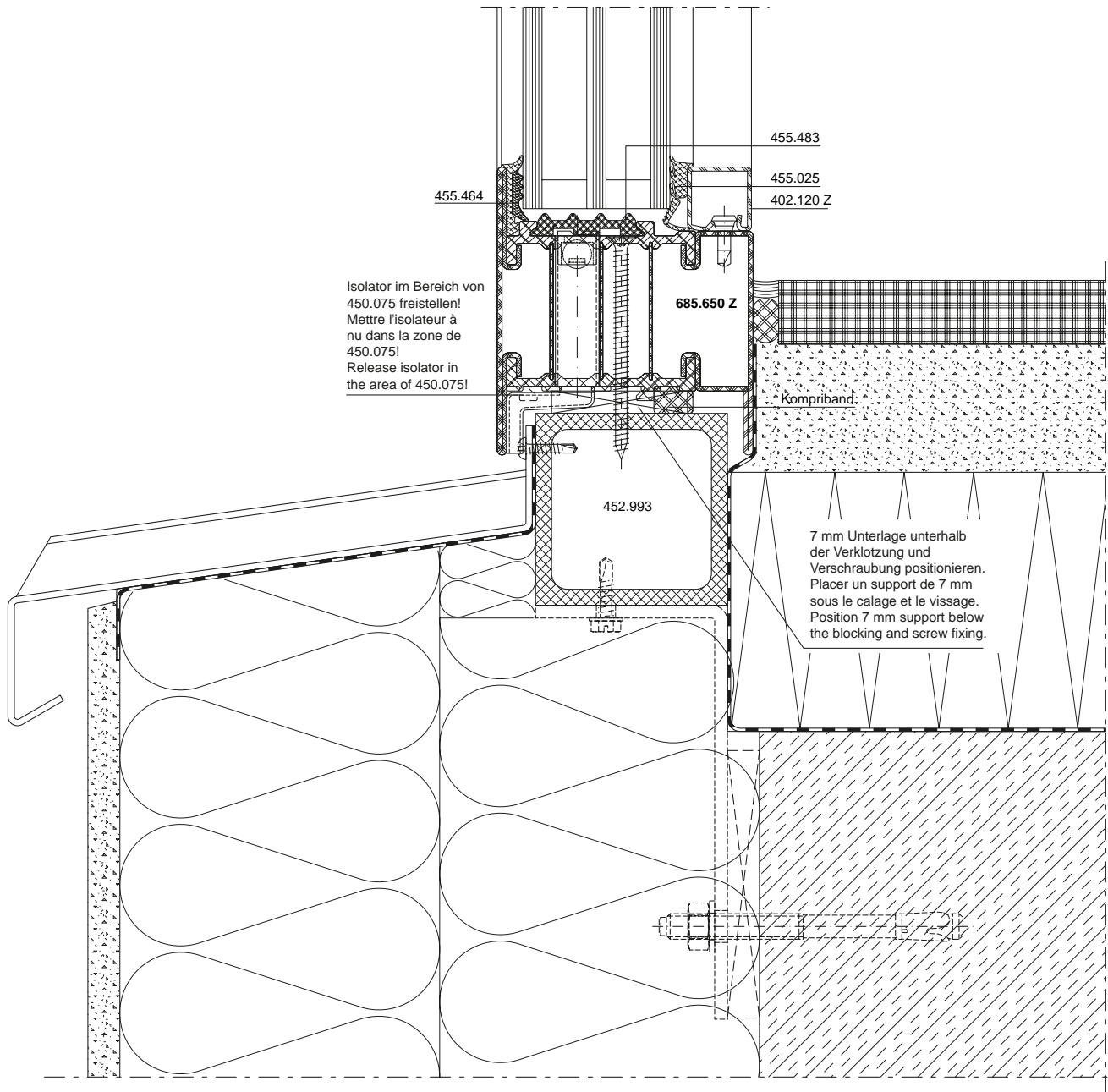

DXF

DWG

12-0201-A-009

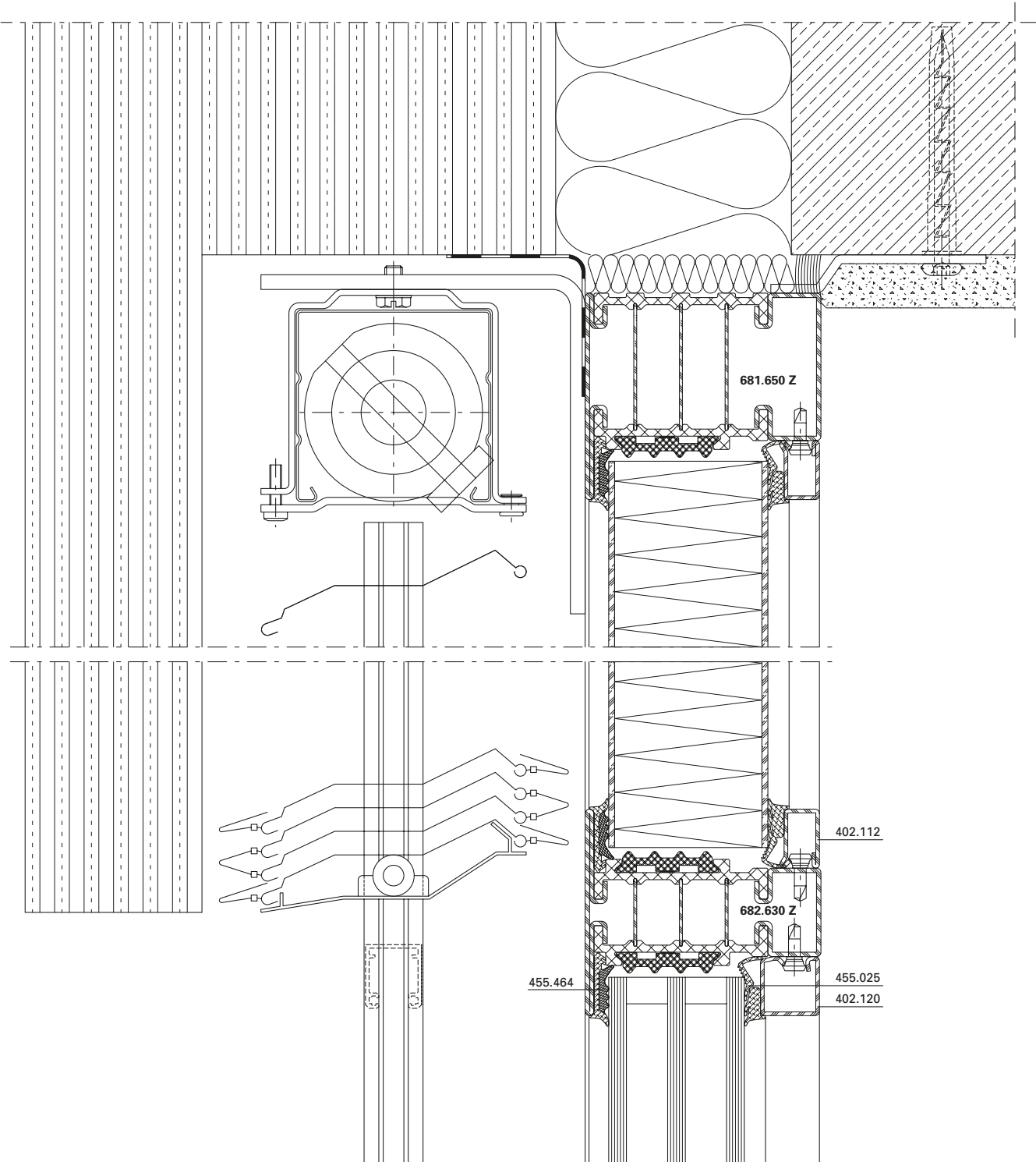

DXF

DWG

12-0201-A-010

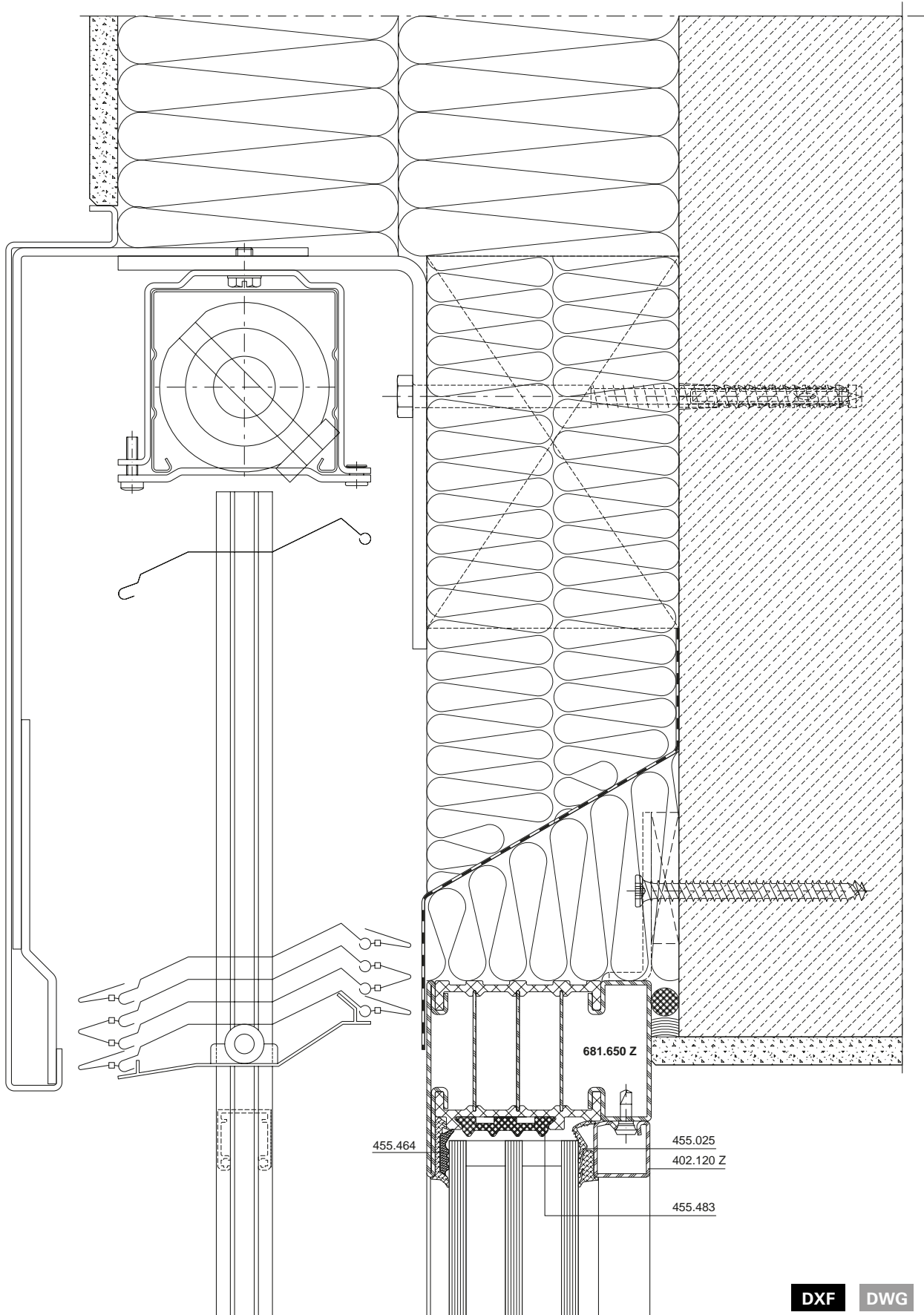

DXF

DWG

12-0201-A-011

Leistungswerte
 Fenster aus Stahl

Caractéristiques de performances
 Fenêtres en acier

Performance values
 Windows made of steel

Schlagregendichtheit
 Luftdurchlässigkeit
 Widerstand bei Windlast

Étanchéité à la pluie battante
 Perméabilité à l'air
 Résistance à la pression du vent

Watertightness
 Air permeability
 Resistance to wind load

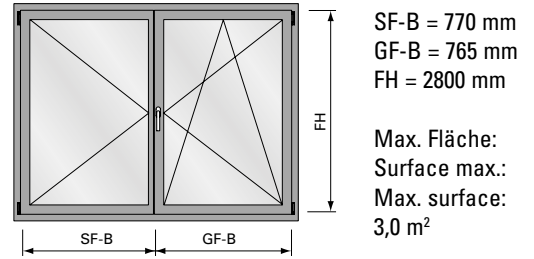
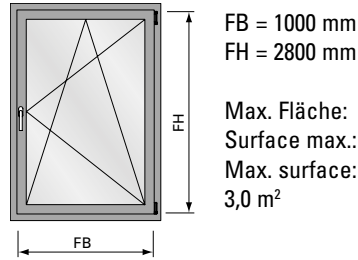

	EN 12208	EN 12207	EN 12210	EN 12208	EN 12207	EN 12210
	Klasse E750 Classe E750 Class E750	Klasse 4 Classe 4 Class 4	Klasse C4/B4 Classe C4/B4 Class C4/B4	Klasse 8A Classe 8A Class 8A	Klasse 4 Classe 4 Class 4	Klasse C4/B4 Classe C4/B4 Class C4/B4
Größenänderungen Variations dimensionnelles Size changes	-100%	-100%	-100%	-100%	-100%	-100%

	EN 12208	EN 12207	EN 12210
	Klasse E750 Classe E750 Class E750	Klasse 4 Classe 4 Class 4	Klasse C4/B4 Classe C4/B4 Class C4/B4
Grösse Festverglasung nach objektspezifischer Glasstatik Taille du vitrage fixe selon la statique du verre spécifique à l'objet Size of fixed glazing according to the glass statics of the specific project			

Leistungswerte für Sondergeometrien

Caractéristiques de performances pour géométrie spéciale

Performances values for special geometry

Schlagregendichtheit
 Luftdurchlässigkeit
 Widerstand bei Windlast

Étanchéité à la pluie battante
 Perméabilité à l'air
 Résistance à la pression du vent

Watertightness
 Air permeability
 Resistance to wind load

Atelierfenster
 Fenêtre trapézoïdale
 Studio window

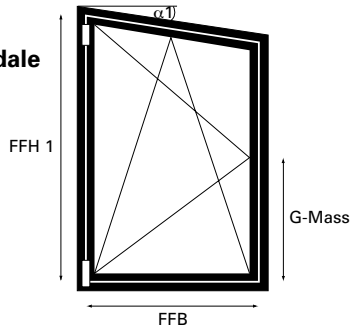

FFB = 1250 mm
 FFH 1 = 2760 mm

Max. Fläche:
 Surface max.:
 Max. surface:
 2.0 m²

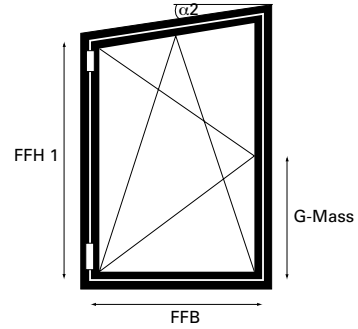

FFB = 1250 mm
 FFH 2 = 2760 mm

Max. Fläche:
 Surface max.:
 Max. surface:
 2.0 m²

	 EN 12208	 EN 12207	 EN 12210
Anschweissband (Drehfenster) Paumelle à souder (Fenêtre à la française) Weld-on hinge (Side-hung window)	Klasse 9A Classe 9A Class 9A	Klasse 4 Classe 4 Class 4	Klasse C4/B4 Classe C4/B4 Class C4/B4
Fensterbeschlag Ferrure de fenêtre Window fitting	Klasse 9A Classe 9A Class 9A	Klasse 4 Classe 4 Class 4	Klasse C4/B4 Classe C4/B4 Class C4/B4
Größenänderungen Variations dimensionnelles Size changes	-100%	-100%	-100%

Leistungswerte für Sondergeometrien

Caractéristiques de performances pour géométrie spéciale

Performances values for special geometry

Schlagregendichtheit
 Luftdurchlässigkeit
 Widerstand bei Windlast

Etanchéité à la pluie battante
 Perméabilité à l'air
 Résistance à la pression du vent

Watertightness
 Air permeability
 Resistance to wind load

Kippfenster
 Fenêtre à soufflet
 Bottom-hung window

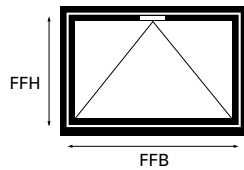

	 EN 12208	 EN 12207	 EN 12210
Anschweisband Schnäpper* Paumelle à souder Loqueteau d'imposte* Weld-on hinge Catch*	Klasse 9A Classe 9A Class 9A	Klasse 4 Classe 4 Class 4	Klasse C3/B3 Classe C3/B3 Class C3/B3
Größenänderungen Variations dimensionnelles Size changes	-100%	-100%	-100%

FFB = 2760 mm
 FFH = 960 mm

Max. Fläche:
 Surface max.:
 Max. surface:
 2.84 m²

* max. Verriegelungsabstand = 1810 mm
 * distance de verrouillage max. = 1810 mm
 * max. distance between locking points = 1810 mm

	 EN 12208	 EN 12207	 EN 12210
Anschweisband Oberlichtöffner F200* Paumelle à souder Ferrure d'imposte F200* Weld-on hinge Top light opener F200*	Klasse 9A Classe 9A Class 9A	Klasse 4 Classe 4 Class 4	Klasse C4/B4 Classe C4/B4 Class C4/B4
Größenänderungen Variations dimensionnelles Size changes	-100%	-100%	-100%

FFB = 2800 mm
 FFH = 960 mm

Max. Fläche:
 Surface max.:
 Max. surface:
 2.84 m²

* max. Verriegelungsabstand = 1440 mm
 * distance de verrouillage max. = 1440 mm
 * max. distance between locking points = 1440 mm

Leistungswerte für Sondergeometrien

Caractéristiques de performances pour géométrie spéciale

Performances values for special geometry





Schlagregendichtheit
 Luftdurchlässigkeit
 Widerstand bei Windlast

Étanchéité à la pluie battante
 Perméabilité à l'air
 Résistance à la pression du vent

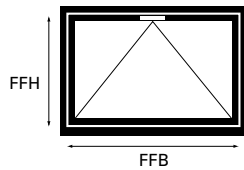
Watertightness
 Air permeability
 Resistance to wind load

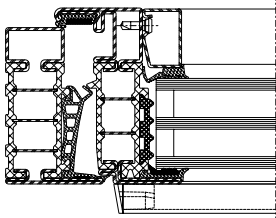
Kippfenster
 Fenêtre à soufflet
 Bottom-hung window



	 EN 12208	 EN 12207	 EN 12210	
	Anschweisband Kettenantrieb EM/2* Paumelle à souder Entraînement à chaîne EM/2* Weld-on hinge Chaîne drive EM/2*	Klasse 9A Classe 9A Class 9A	Klasse 4 Classe 4 Class 4	Klasse C4/B4 Classe C4/B4 Class C4/B4
	Größenänderungen Variations dimensionnelles Size changes	-100%	-100%	-100%

FFB = 2760 mm
 FFH = 960 mm

Max. Fläche:
 Surface max.:
 Max. surface:
 2.84 m²

- * max. Verriegelungsabstand = 1810 mm
- * distance de verrouillage max. = 1810 mm
- * max. distance between locking points = 1810 mm

Leistungswerte für Sondergeometrien

Caractéristiques de performances pour géométrie spéciale

Performances values for special geometry

Schlagregendichtheit
 Luftdurchlässigkeit
 Widerstand bei Windlast

Etanchéité à la pluie battante
 Perméabilité à l'air
 Résistance à la pression du vent

Watertightness
 Air permeability
 Resistance to wind load

Kippfenster
 Fenêtre à soufflet
 Bottom-hung window

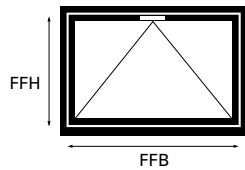

	 EN 12208	 EN 12207	 EN 12210
Kippflügelband Standard Schnäpper* Charnière d'imposte Standard Loqueteau d'imposte* Bottom-hung hinge Standard Catch*	Klasse 8A Classe 8A Class 8A	Klasse 2 Classe 2 Class 2	Klasse C3/B3 Classe C3/B3 Class C3/B3
Größenänderungen Variations dimensionnelles Size changes	-100%	-100%	-100%

FFB = 2760 mm
 FFH = 960 mm

Max. Fläche:
 Surface max.:
 Max. surface:
 2.84 m²

* max. Verriegelungsabstand = 1810 mm
 * distance de verrouillage max. = 1810 mm
 * max. distance between locking points = 1810 mm

	 EN 12208	 EN 12207	 EN 12210
Kippflügelband Standard Oberlichtöffner F200* Charnière d'imposte Standard Ferrure d'imposte F200* Bottom-hung hinge Standard Top light opener F200*	Klasse 6A Classe 6A Class 6A	Klasse 2 Classe 2 Class 2	Klasse C2/B2 Classe C2/B2 Class C2/B2
Größenänderungen Variations dimensionnelles Size changes	-100%	-100%	-100%

FFB = 2760 mm
 FFH = 960 mm

Max. Fläche:
 Surface max.:
 Max. surface:
 2.84 m²

* max. Verriegelungsabstand = 1440 mm
 * distance de verrouillage max. = 1440 mm
 * max. distance between locking points = 1440 mm

Leistungswerte für Sondergeometrien

Caractéristiques de performances pour géométrie spéciale

Performances values for special geometry

Schlagregendichtheit
 Luftdurchlässigkeit
 Widerstand bei Windlast

Étanchéité à la pluie battante
 Perméabilité à l'air
 Résistance à la pression du vent

Watertightness
 Air permeability
 Resistance to wind load

Kippfenster
 Fenêtre à soufflet
 Bottom-hung window

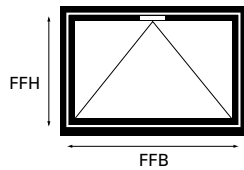

	 EN 12208	 EN 12207	 EN 12210
Kippflügelband Standard Kettenantrieb EM/2* Charnière d'imposte Standard Entraînement à chaîne EM/2* Bottom-hung hinge Standard Chaîne drive EM/2*	Klasse 7A Classe 7A Class 7A	Klasse 2 Classe 2 Class 2	Klasse C3/B3 Classe C3/B3 Class C3/B3
Größenänderungen Variations dimensionnelles Size changes	-100%	-100%	-100%

FFB = 2760 mm
 FFH = 960 mm

Max. Fläche:
 Surface max.:
 Max. surface:
 2.84 m²

- * max. Verriegelungsabstand = 1810 mm
- * distance de verrouillage max. = 1810 mm
- * max. distance between locking points = 1810 mm

U_f-Werte
(nach EN ISO 10077-2:2018-01)

Auf den folgenden Seiten finden Sie die U_f-Werte für die verschiedenen Anwendungen von Janisol HI-Fenster.

Sie basieren auf folgenden Grundlagen:

- Stahl
- Profile bandverzinkter Stahl, unbeschichtet
 - Stahl-Glasleisten
 - Trockenverglasung

Valeurs U_f
(selon EN ISO 10077-2:2018-01)

Vous trouverez les valeurs U_f pour les différentes applications Janisol HI fenêtres dans les pages qui suivent.

Elles se basent sur les principes suivants:

- Acier
- Profilés en bande d'acier zingué, sans revêtement
 - Parcloses en acier
 - Vitrage à sec

U_f values
(according to EN ISO 10077-2:2018-01)

On the following pages you will find the U_f values for the various applications for Janisol HI windows.

They are based on the following:

- Steel
- Strip galvanised steel profiles, uncoated
 - Steel glazing beads
 - Glazing with dry glazing

U_f-Werte
 (nach EN ISO 10077-2:2018-01)

Valeurs U_f
 (selon EN ISO 10077-2:2018-01)

U_f values
 (according to EN ISO 10077-2:2018-01)

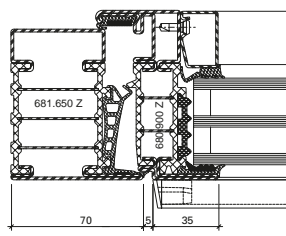
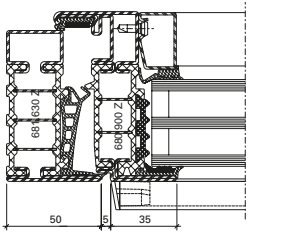
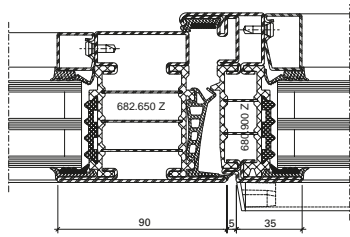
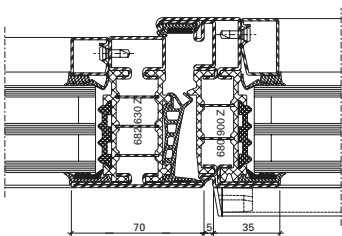
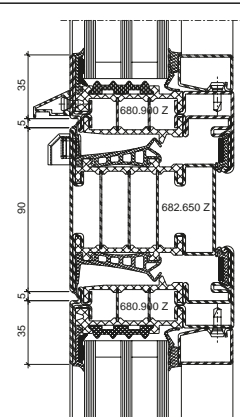
	Füllelementstärken Elements de remplissages Infill elements			
	≥ 46 mm	≥ 36 mm	≥ 36 mm*	≥ 24 mm*
	1,2 W/m²K	1,2 W/m²K	1,3 W/m²K	1,3 W/m²K
	1,3 W/m²K	1,3 W/m²K	1,4 W/m²K	1,5 W/m²K
	1,1 W/m²K	1,2 W/m²K	1,3 W/m²K	1,4 W/m²K
	1,2 W/m²K	1,3 W/m²K	1,4 W/m²K	1,5 W/m²K
	1,2 W/m²K	1,3 W/m²K	1,4 W/m²K	1,4 W/m²K

* ohne Dämmprofil
 * sans profilé isolant
 * without insulating profile

U_f-Werte
 (nach EN ISO 10077-2:2018-01)

Valeurs U_f
 (selon EN ISO 10077-2:2018-01)

U_f values
 (according to EN ISO 10077-2:2018-01)

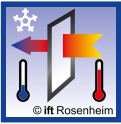
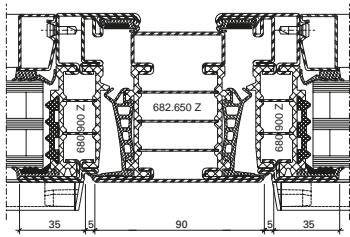
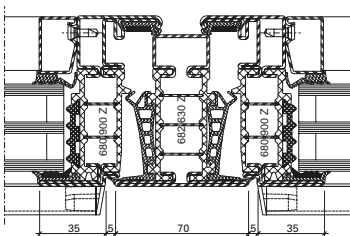
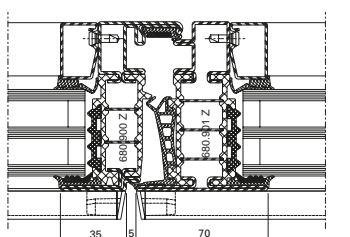
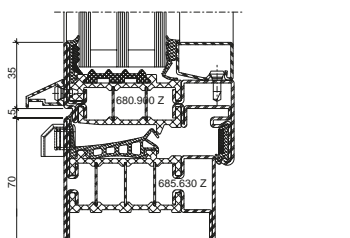
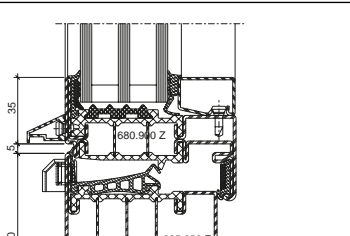
	Füllelementstärken Elements de remplissages Infill elements			
	≥ 46 mm	≥ 36 mm	≥ 36 mm*	≥ 24 mm*
	1,2 W/m ² K	1,3 W/m ² K	1,4 W/m ² K	1,4 W/m ² K
	1,3 W/m ² K	1,4 W/m ² K	1,5 W/m ² K	1,5 W/m ² K
	1,2 W/m ² K	1,3 W/m ² K	1,5 W/m ² K	1,6 W/m ² K
	1,2 W/m ² K	1,2 W/m ² K	1,3 W/m ² K	1,4 W/m ² K
	1,1 W/m ² K	1,1 W/m ² K	1,2 W/m ² K	1,2 W/m ² K

* ohne Dämmprofil
 * sans profilé isolant
 * without insulating profile

U_f-Werte
 (nach EN ISO 10077-2:2018-01)

Valeurs U_f
 (selon EN ISO 10077-2:2018-01)

U_f values
 (according to EN ISO 10077-2:2018-01)

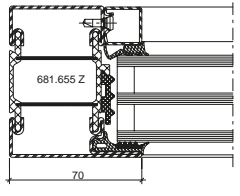
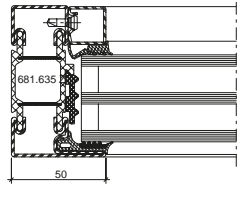
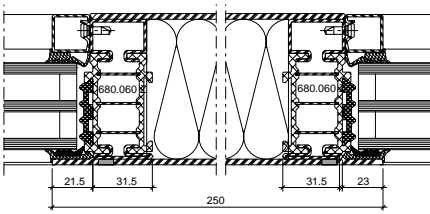
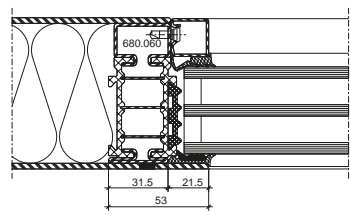
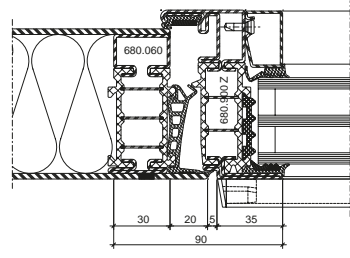
	Füllelementstärken Elements de remplissages Infill elements			
	≥ 46 mm	≥ 36 mm	≥ 36 mm*	≥ 24 mm*
	1,2 W/m²K	1,3 W/m²K	1,4 W/m²K	1,6 W/m²K
	1,4 W/m²K	1,5 W/m²K	1,7 W/m²K	1,9 W/m²K
	0,74 W/m²K	0,77 W/m²K	0,85 W/m²K	0,91 W/m²K
	1,2 W/m²K	1,3 W/m²K	1,4 W/m²K	1,5 W/m²K
	1,3 W/m²K	1,4 W/m²K	1,5 W/m²K	1,6 W/m²K

* ohne Dämmprofil
 * sans profilé isolant
 * without insulating profile

U_f-Werte
 (nach EN ISO 10077-2:2018-01)

Valeurs U_f
 (selon EN ISO 10077-2:2018-01)

U_f values
 (according to EN ISO 10077-2:2018-01)

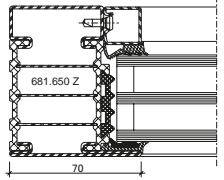
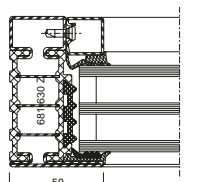
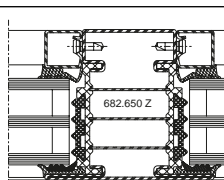
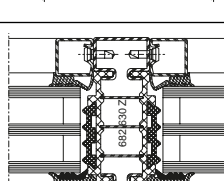
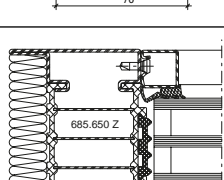
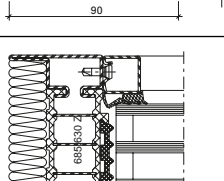
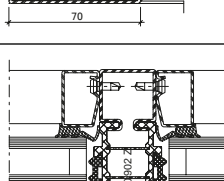
	Füllelementstärken Elements de remplissages Infill elements			
	≥ 46 mm	≥ 36 mm	≥ 36 mm*	≥ 24 mm*
	0,89 W/m²K	0,95 W/m²K	1,1 W/m²K	1,2 W/m²K
	1,0 W/m²K	1,1 W/m²K	1,3 W/m²K	1,4 W/m²K
	0,84 W/m²K	0,93 W/m²K	1,1 W/m²K	1,3 W/m²K
	0,93 W/m²K	1,0 W/m²K	1,3 W/m²K	1,5 W/m²K
	0,80 W/m²K	0,85 W/m²K	0,95 W/m²K	1,0 W/m²K
	0,88 W/m²K	0,95 W/m²K	1,1 W/m²K	1,2 W/m²K
	0,93 W/m²K	1,1 W/m²K	1,3 W/m²K	1,4 W/m²K

* ohne Dämmprofil
 * sans profilé isolant
 * without insulating profile



Schalldämmung

Ausführungsvarianten

Die nachfolgende Typenübersicht ergibt einen Überblick über die beurteilten Varianten.

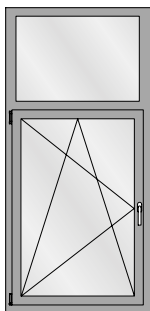
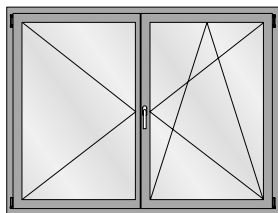
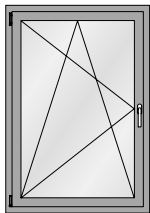

Isolation phonique

Modèles

L'aperçu des types suivant fournit une vue d'ensemble des variantes examinées.

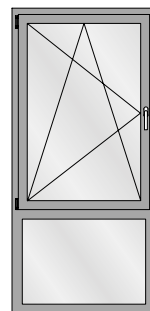
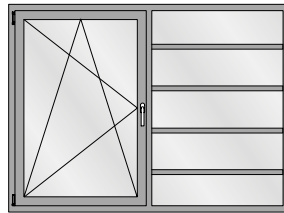
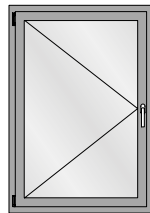

Sound insulation

Design range

The following overview of types provides an overview of the evaluated designs.



Tabelle A1
 Korrekturtabelle für Janisol HI-Fenster
 mit Mehrscheiben-Isolierglas

Tableau A1
 Tableau de correction pour les
 fenêtres Janisol HI avec vitrage isolant
 multi-vitres

Table A1
 Correction table for Janisol HI
 windows with multi-pane insulating
 glass

	1	2	7	8	9	10	11	12	13	14	15
	$R_{W(C, Ctr)}$ dB	Isolierglaseinheit Unité d'isolation Insulating glass unit $R_{W, P, Glas}$ dB	Korrekturen Corrections Corrections								
			K_{RA} dB	K_S dB	K_{FV} dB	K_{Nass} dB	$K_{G 0,4}$ dB	$K_{G 1,0}$ dB	$K_{G 1,8}$ dB	$K_{G 2,6}$ dB	$K_{G 3,2}$ dB
1	33 (-2; -6)	31	-2	0	-1	0	0	0	-1	-2	-3
2	34 (-2; -6)	32	-2	0	-1	0	0	0	-1	-2	-3
3	35 (-2; -6)	34	-2	0	-1	0	0	0	-1	-2	-3
4	36 (-2; -6)	35	-2	0	-1	-1	0	0	-1	-2	-3
5	37 (-2; -6)	37	-2	0	0	-1	0	0	-1	-2	-3
6	38 (-2; -6)	39	-2	0	0	-1	0	0	-1	-2	-3
7	39 (-2; -6)	40	-2	0	0	-1	0	0	-1	-2	-3
8	40 (-2; -4)	41	-2	0	0	-1	-1	0	-1	-2	-3
9	41 (-2; -4)	42	0	0	0	-1	-2	0	-1	-2	-3
10	42 (-2; -4)	43	0	-1	0	-1	-2	0	-1	-2	-3
11	43 (-2; -4)	44	0	-2	0	-1	-2	0	-1	-2	-3
12	44 (-2; -5)	45	0	-2	0	-1	-3	0	-1	-2	-3
13	45 (-2; -5)	49	0	-2	+1	-1	-3	0	-1	-2	-3
14	46 (-2; -6)	50	-1	-3	0	-1	-4	-1	-1	-2	-3

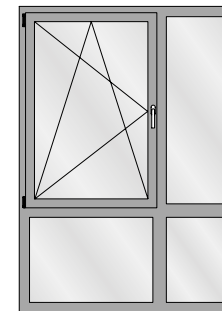
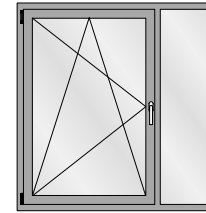
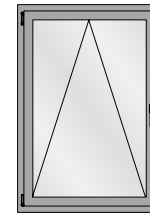
Der aus der Tabelle A1 abzulesende Wert für die Schalldämmung $R_{W, Fenster}$ beträgt:

La valeur à relever sur le tableau A1 concernant l'isolement contre les sons aériens $R_{W, Fenêtre}$ est la suivante:

The value taken from table A1 for the sound insulation $R_{W, Window}$ is:

$$R_{W, Fenster} = R_W + K_{RA} + K_S + K_{FV} + K_{Nass} + K_{G 0,4} + K_{G 1,8} + K_{G 2,6} + K_{G 3,2} \text{ dB}$$

K_{RA} Korrekturwert für einen Rahmenanteil < 30%. Der Rahmenanteil ist die Gesamtfläche des Fensters abzüglich der sichtbaren Scheibengröße. K_{RA} darf bei Festverglasungen nicht berücksichtigt werden.

K_S Korrekturwert für Stulpfenster

K_{FV} Korrekturwert für Festverglasungen mit erhöhtem Scheibenanteil

K_{Nass} Korrekturwert für Nassverglasung

$K_{G 0,4}$ Korrekturwert für Einzelscheiben mit einer Glasfläche $\leq 0,4 \text{ m}^2$. Die Korrektur gilt auch für Konstruktionen mit glasteilenden Sprossen.

$K_{G 1,0}$ Korrekturwert für Einzelscheiben mit einer Glasfläche $\geq 1,0 \text{ m}^2$

$K_{G 1,8}$ Korrekturwert für Einzelscheiben mit einer Glasfläche $\geq 1,8 \text{ m}^2$

$K_{G 2,6}$ Korrekturwert für Einzelscheiben mit einer Glasfläche $\geq 2,6 \text{ m}^2$

$K_{G 3,2}$ Korrekturwert für Einzelscheiben mit einer Glasfläche $\geq 3,2 \text{ m}^2$

R_W bewertetes Schalldämm-Mass des Fensters in Abhängigkeit von der Schalldämmung $R_{W,P, Glas}$

$R_{W,P, Glas}$ bewertetes Schalldämm-Mass (Prüfwert) der Isolierverglasung. Die Werte müssen über eine Prüfung nach ISO 140-3 an einem Prüfmuster im Format 1230 x 1480 mm ermittelt und durch einen Prüfbericht einer anerkannten Prüfstelle nachgewiesen werden. Alternativ können generische Daten nach DIN EN 12758 verwendet werden.

K_{RA} Valeur de correction pour un pourcentage de cadre < 30%. Le pourcentage du cadre est la surface totale de la fenêtre déduite de la dimension de vitre visible. K_{RA} ne doit pas être pris en compte sur les vitrages fixes.

K_S Valeur de correction pour fenêtres à deux vantaux

K_{FV} Valeur de correction pour vitrages fixes à fort pourcentage de vitre

K_{Nass} Valeur de correction pour vitrage avec mastic

$K_{G 0,4}$ Valeur de correction pour vitres individuelles avec une surface vitrée $\leq 0,4 \text{ m}^2$. La correction s'applique aussi aux constructions à meneaux séparant les vitres.

$K_{G 1,0}$ Valeur de correction pour vitres individuelles avec surface vitrée $\geq 1,0 \text{ m}^2$

$K_{G 1,8}$ Valeur de correction pour vitres individuelles avec surface vitrée $\geq 1,8 \text{ m}^2$

$K_{G 2,6}$ Valeur de correction pour vitres individuelles avec surface vitrée $\geq 2,6 \text{ m}^2$

$K_{G 3,2}$ Valeur de correction pour vitres individuelles avec surface vitrée $\geq 3,2 \text{ m}^2$

R_W Mesure d'isolement contre les sons aériens des fenêtres évaluée suivant l'isolement phonique $R_{W,P, vitrage}$

$R_{W,P, vitrage}$ Mesure d'isolement contre les sons aériens (valeur d'essai) du vitrage isolant évaluée. Les valeurs doivent être déterminées par un essai suivant ISO 140-3 sur un spécimen de format 1230x1480 mm et attestées par le procès-verbal d'un bureau de vérification homologué. Alternativement, il est possible d'utiliser des données génériques suivant DIN EN 12758.

K_{RA} Correction value for a frame proportion < 30%. The frame proportion is the total surface area of the window less the visible pane area. K_{RA} must not be taken into account for fixed glazing.

K_S Correction value for double-vent windows

K_{FV} Correction value for fixed glazing with increased proportion of pane

K_{Nass} Correction value for glazing with sealing

$K_{G 0,4}$ Correction value for single panes with a glass area $\leq 0,4 \text{ m}^2$. The correction also applies to buildings with glazing bars

$K_{G 1,0}$ Correction value for single panes with a glass area $\geq 1,0 \text{ m}^2$

$K_{G 1,8}$ Correction value for single panes with a glass area $\geq 1,8 \text{ m}^2$

$K_{G 2,6}$ Correction value for single panes with a glass area $\geq 2,6 \text{ m}^2$

$K_{G 3,2}$ Correction value for single panes with a glass area $\geq 3,2 \text{ m}^2$

R_W Airborne sound reduction index of windows depending on the sound insulation $R_{W,P, glazing}$

$R_{W,P, glazing}$ Airborne sound reduction index (test value) of insulating glazing. The values must be calculated using a test conducted in accordance with ISO 140-3 for a specimen with the dimensions 1230 x 1480 mm and confirmed by a test report of a recognised test centre. Alternatively, generic data can be used in accordance with DIN EN 12758.

METALFORM

MASTERS OF METAL

UNITED KINGDOM

METALFORM

NORWAYMETAL LTD

53 Chelsea Manor Street

London, SW3 5RZ

SALES@METALFORM.UK

+44 20 81298814

GERMANY

METALFORM GMBH

Carl-Zeiss-Ring 15A

85737 Ismaning

SALES@METALFORMGROUP.DE

+49 17663630406

NORWAY

METALFORM AS

Brochmannsveien 2

1950 Rømskog

SALG@METALFORM.NO

+47 401 62 446

METALFORMGROUP

SALES@METALFORMGROUP.COM